

UATYARPH9
UATYARPH10

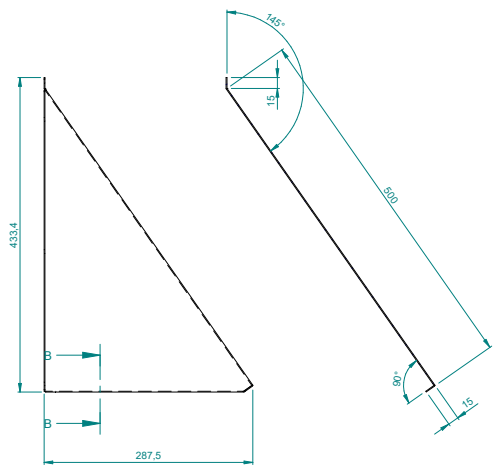

Section A-A

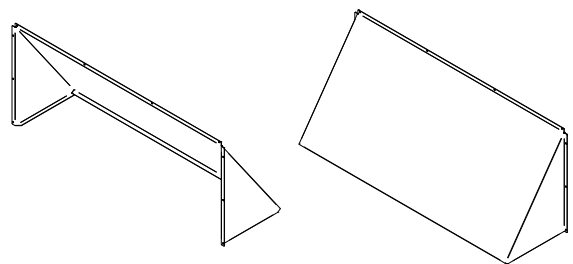
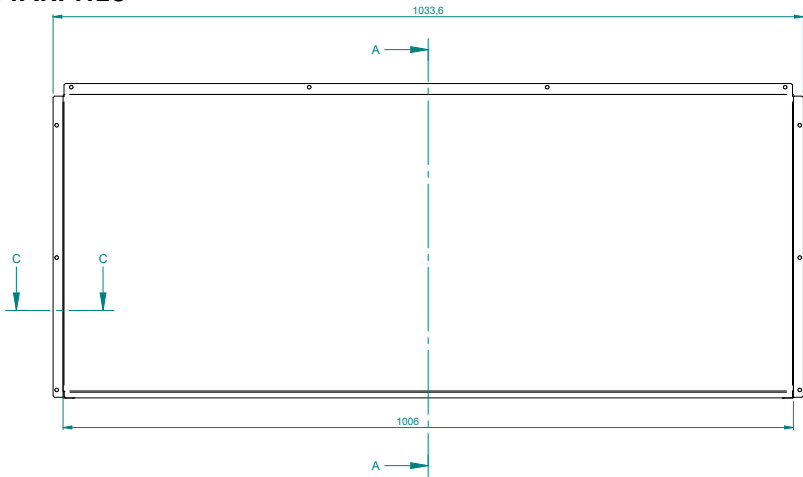

Section C-C

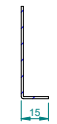

Section B-B