

SHEET	DESCRIPTION
1	FRONT PAGE
2	POWER COMPRESSOR
3	CRANCASE HEATERS POWER SUPPLY
4	KIT PUMPS
5	CIRCUIT FAN POWER SUPPLY
6	UNIT CONTROL CIRCUIT POWER SUPPLY
7	ANALOG INPUTS-OUTPUT BOARD
8	DIGITAL INPUTS BOARD
9	DIGITAL OUTPUTS BOARD
10	EXPANSION INPUT / OUTPUT UNIT ALARM & LIMITING
11	HEAT RECOVERY CONTROL BOARD (OPTIONAL)
12	EXPANSION CONTROL COMPRESSOR
13	EXPANSION CONTROL COMPRESSOR
14	EEXV COMPRESSOR
15	PUMPS CONTROL
16	COMMUNICATION MODULES (OPTIONAL)
17	TERMINALS M01 - M1
18	TERMINALS M400 - M115 - M24
19	TERMINALS MC115 - MC24
20	LEGEND
21	LEGEND
22	LEGEND
23	NOTES
24	FIELD WIRING CONNECTION

WIRING DIAGRAM

EWAD 100E ÷ 210E-SS/SL

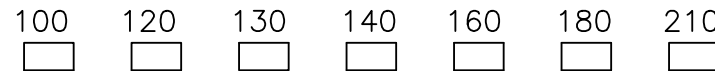

ERAD 120E ÷ 250E-SS/SL

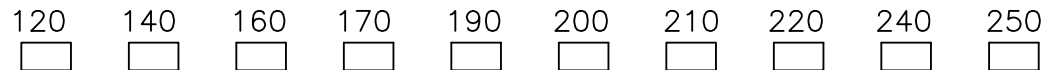

- VERSIONE REGOLAZIONE CONTINUA VENTILATORI -
- FAN SPEED MODULATION VERSION -

- MicroTech® III -

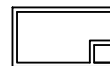

OPTIONAL EQUIPMENTS

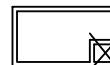

EQUIPMENT INSTALLED

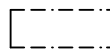

ELECTRICAL EQUIPMENT
INSTALLED ON COMPRESSOR
TERMINALS BOX



NOT TO BE INSTALLED ON "CU" VERSION



FIELD WIRING CONNECTIONS



REMOVE THIS WIRE OR MJ IF THE OPTION IS REQUESTED



MANUAL RESET

REV.	DATE	HISTORY REVISIONS	DWG.	CHECK.	PASSED.
5	10-10-11	Revised pag. 2 e 23	M.P.	M.P.	
4	28-07-11	Added terminal "529" M115 to pag.12	M.P.	M.P.	
3	08-03-11	Revised "OP16" to pag. 2	M.P.	M.P.	
2	14-01-11	Changed EEXV to pag. 14	M.P.	M.P.	
1	15-12-10	Changed fans VFD as ECO. 2899 to pag. 5	M.P.	M.P.	

DIAGRAM N.:

180445

File: (180445/1804451)

Code ID:

DATE: 30/03/2010

REV: 5

DWG.

DAIKIN EUROPE NV

This document is reserved property. Reproduction or use for any purpose without our authorization is strictly forbidden by law.

CHECK.

PASSED.

1 | 2 | 3 | 4 | 5 | 6 | 7 | 8 | 9 | 10 | 11 | 12 | 13 | 14 | 15 | 16 | 17 | 18 | 19 | 20

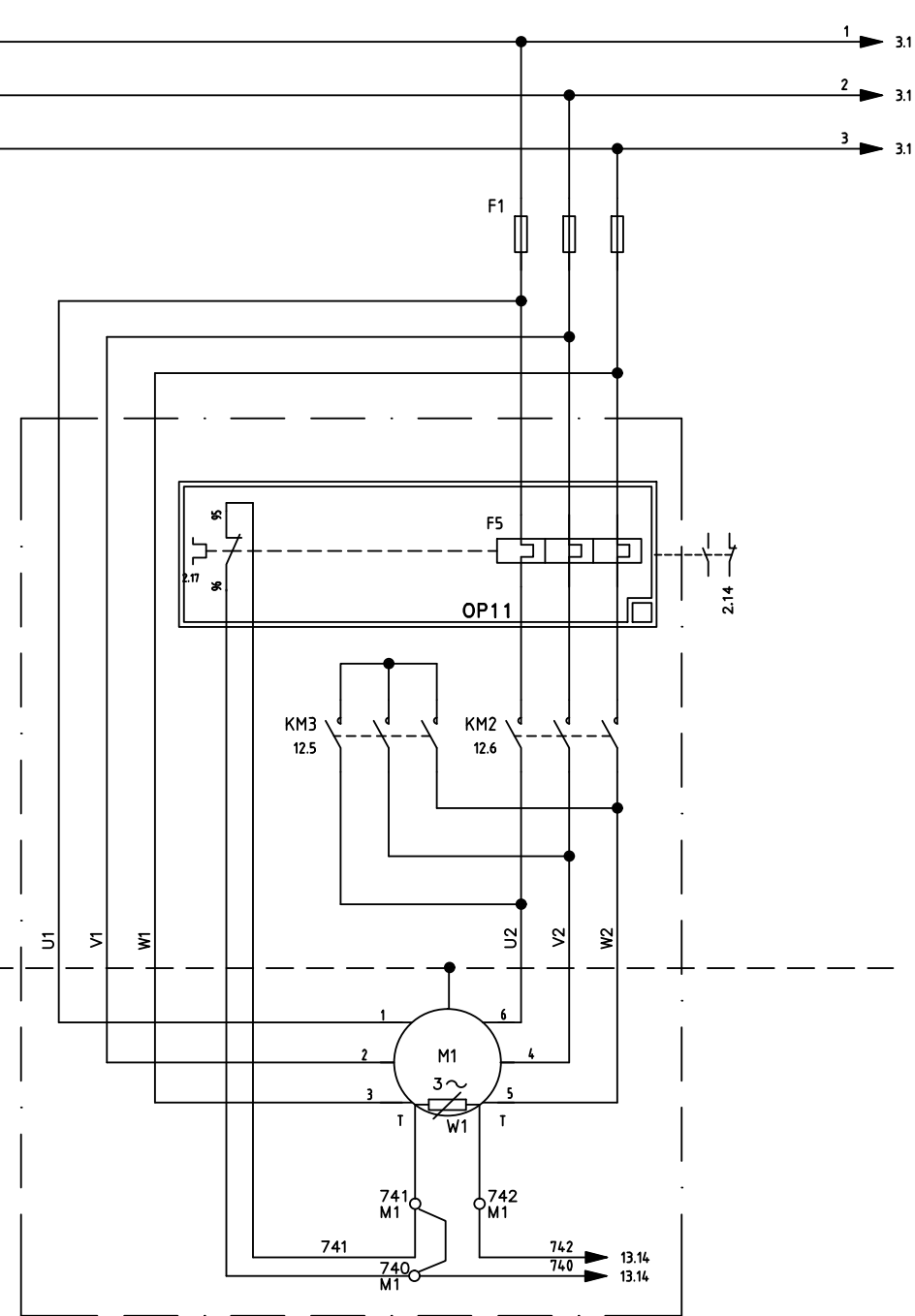
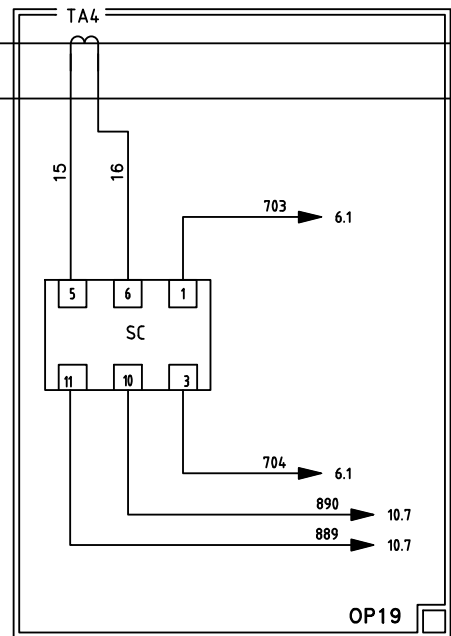
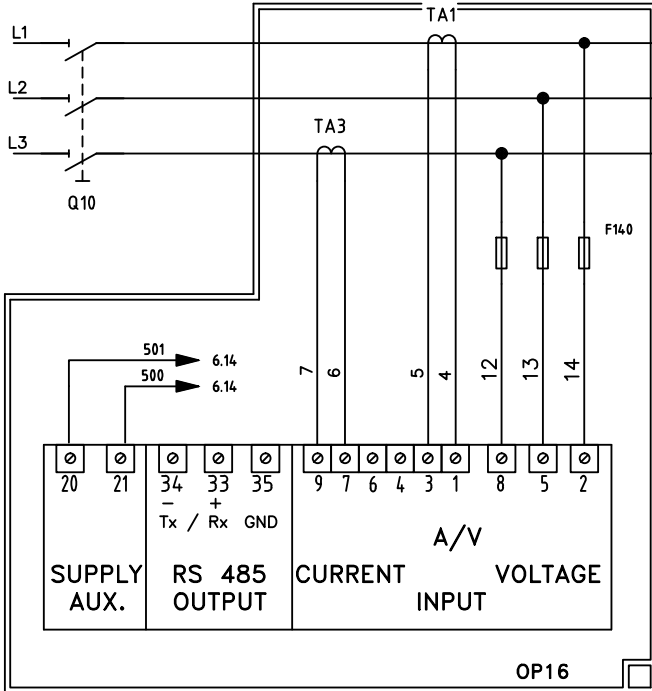

1 | 2 | 3 | 4 | 5 | 6 | 7 | 8 | 9 | 10 | 11 | 12 | 13 | 14 | 15 | 16 | 17 | 18 | 19 | 20

1 | 2 | 3 | 4 | 5 | 6 | 7 | 8 | 9 | 10 | 11 | 12 | 13 | 14 | 15 | 16 | 17 | 18 | 19 | 20

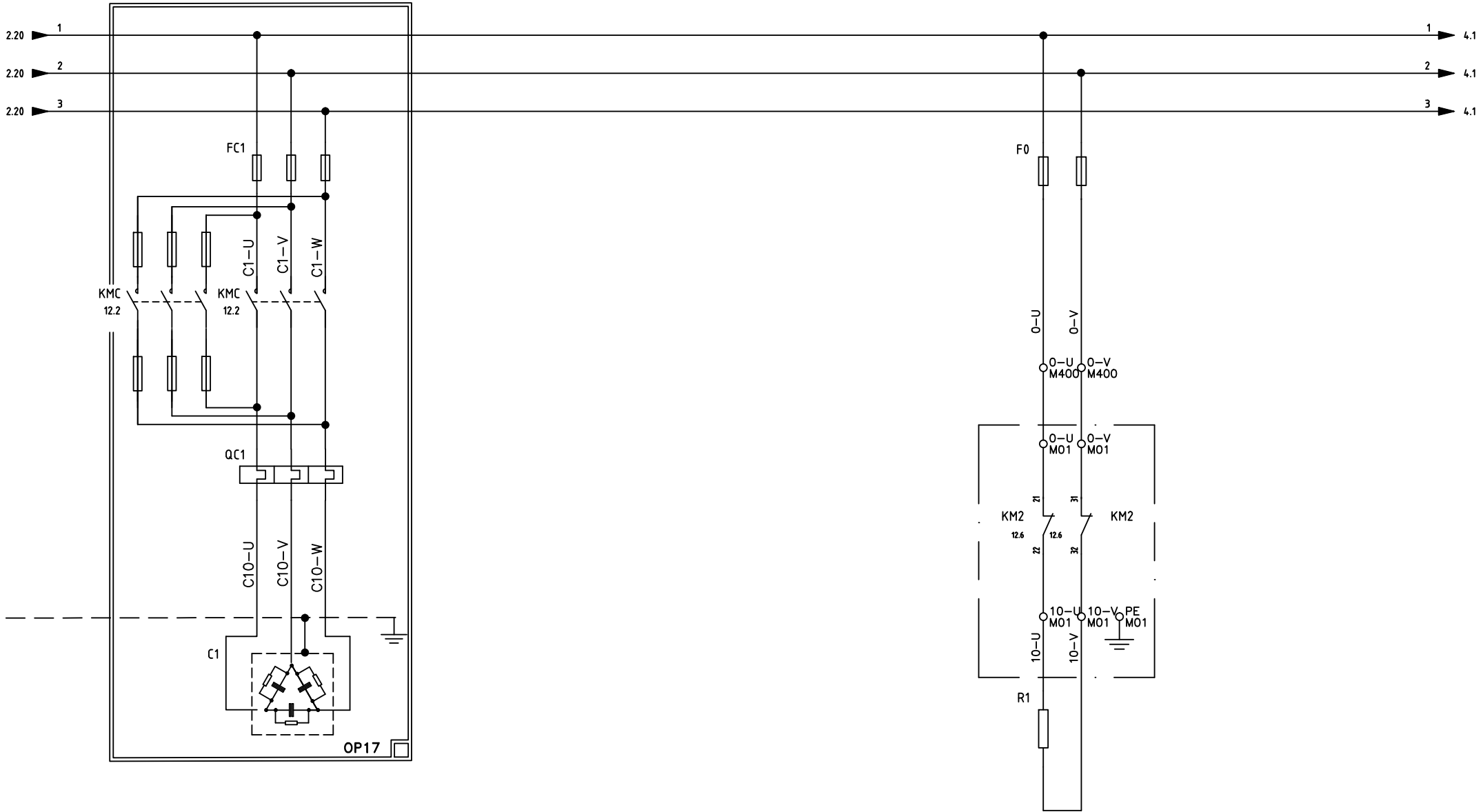

1 | 2 | 3 | 4 | 5 | 6 | 7 | 8 | 9 | 10 | 11 | 12 | 13 | 14 | 15 | 16 | 17 | 18 | 19 | 20

1 | 2 | 3 | 4 | 5 | 6 | 7 | 8 | 9 | 10 | 11 | 12 | 13 | 14 | 15 | 16 | 17 | 18 | 19 | 20

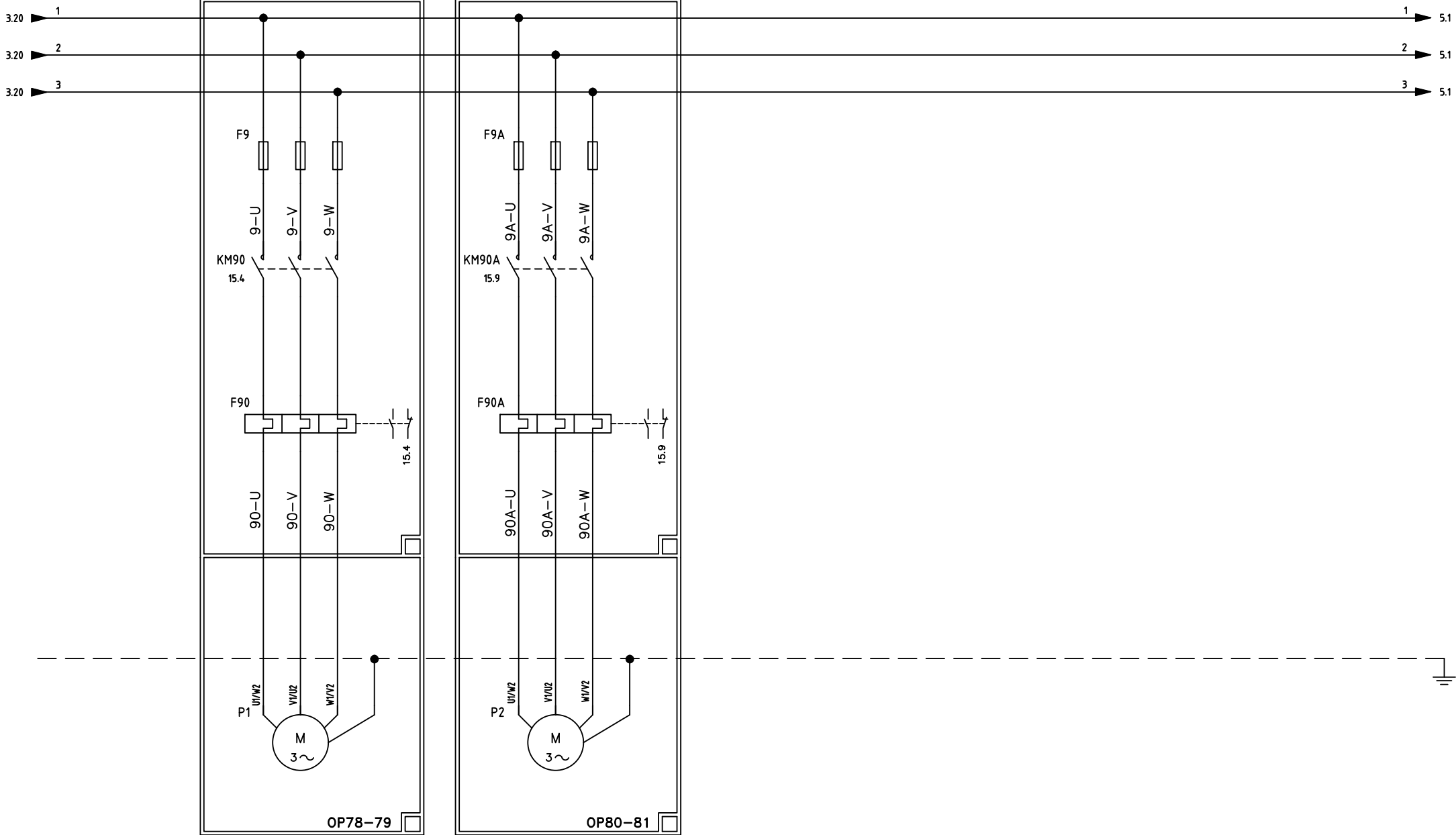

1 | 2 | 3 | 4 | 5 | 6 | 7 | 8 | 9 | 10 | 11 | 12 | 13 | 14 | 15 | 16 | 17 | 18 | 19 | 20

1 | 2 | 3 | 4 | 5 | 6 | 7 | 8 | 9 | 10 | 11 | 12 | 13 | 14 | 15 | 16 | 17 | 18 | 19 | 20

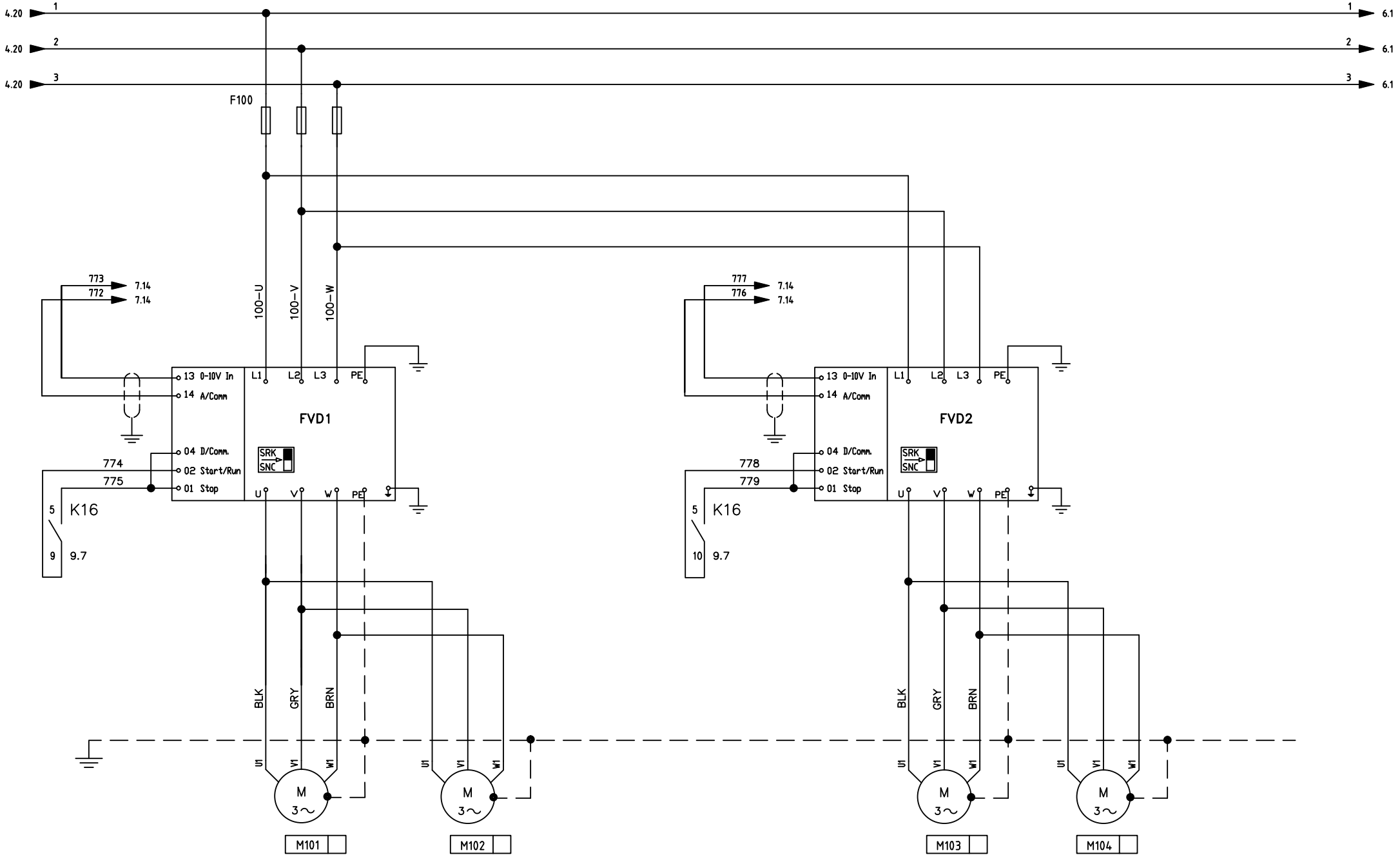

1 | 2 | 3 | 4 | 5 | 6 | 7 | 8 | 9 | 10 | 11 | 12 | 13 | 14 | 15 | 16 | 17 | 18 | 19 | 20

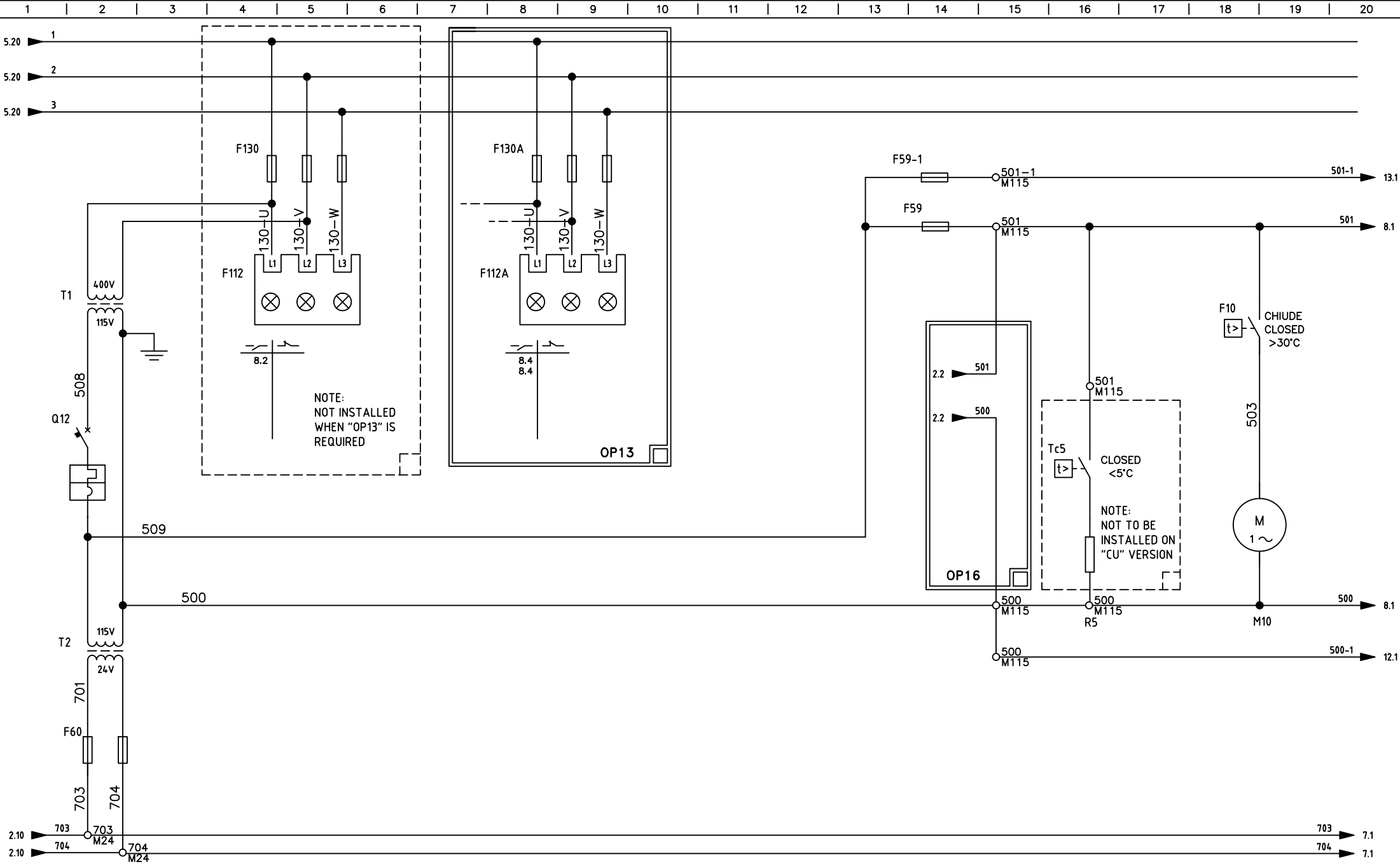

1 | 2 | 3 | 4 | 5 | 6 | 7 | 8 | 9 | 10 | 11 | 12 | 13 | 14 | 15 | 16 | 17 | 18 | 19 | 20

EEWT ELWT

OAT

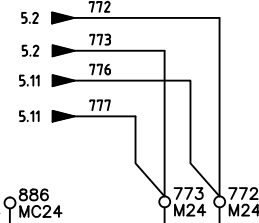

COMMUNICATION
MODULE
CONNECTOR

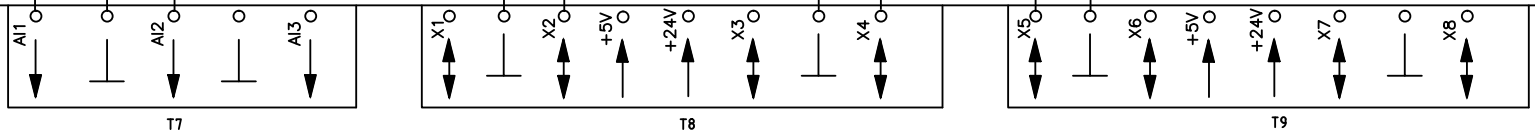

ANALOG INPUT

U.C.

ANALOG OUTPUT

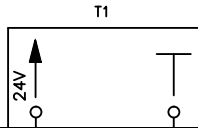

MICROTECH III

POL687.70/MCQ

NOTE:
COMMUNICATION MODULE
(SEE SHEET 16)

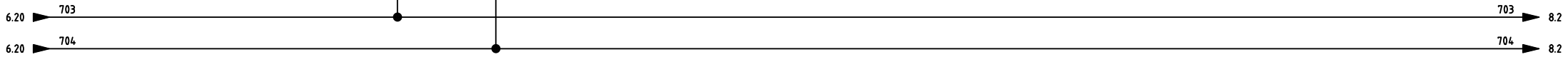

1 | 2 | 3 | 4 | 5 | 6 | 7 | 8 | 9 | 10 | 11 | 12 | 13 | 14 | 15 | 16 | 17 | 18 | 19 | 20

1 | 2 | 3 | 4 | 5 | 6 | 7 | 8 | 9 | 10 | 11 | 12 | 13 | 14 | 15 | 16 | 17 | 18 | 19 | 20

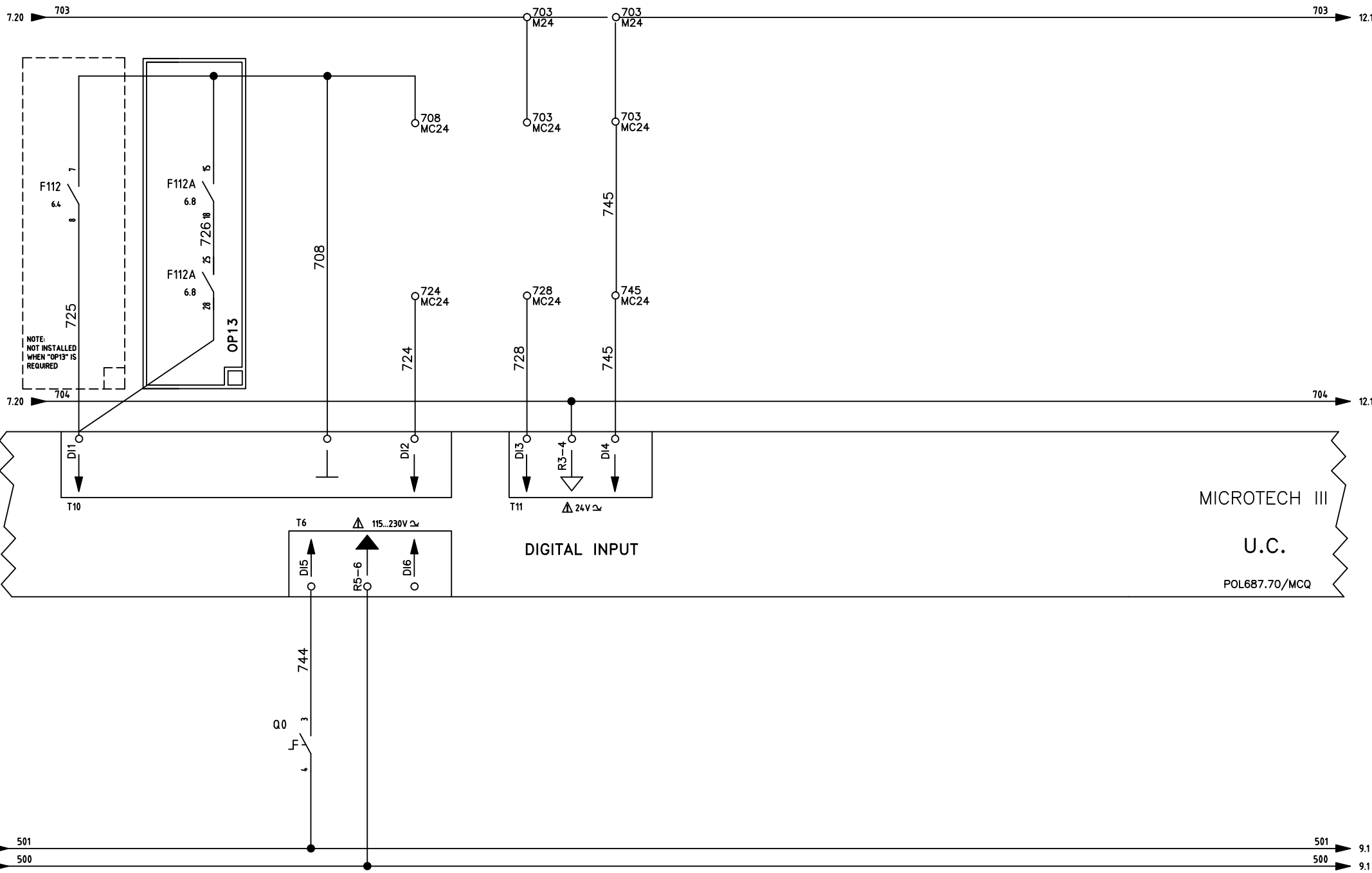

1 | 2 | 3 | 4 | 5 | 6 | 7 | 8 | 9 | 10 | 11 | 12 | 13 | 14 | 15 | 16 | 17 | 18 | 19 | 20

1 | 2 | 3 | 4 | 5 | 6 | 7 | 8 | 9 | 10 | 11 | 12 | 13 | 14 | 15 | 16 | 17 | 18 | 19 | 20

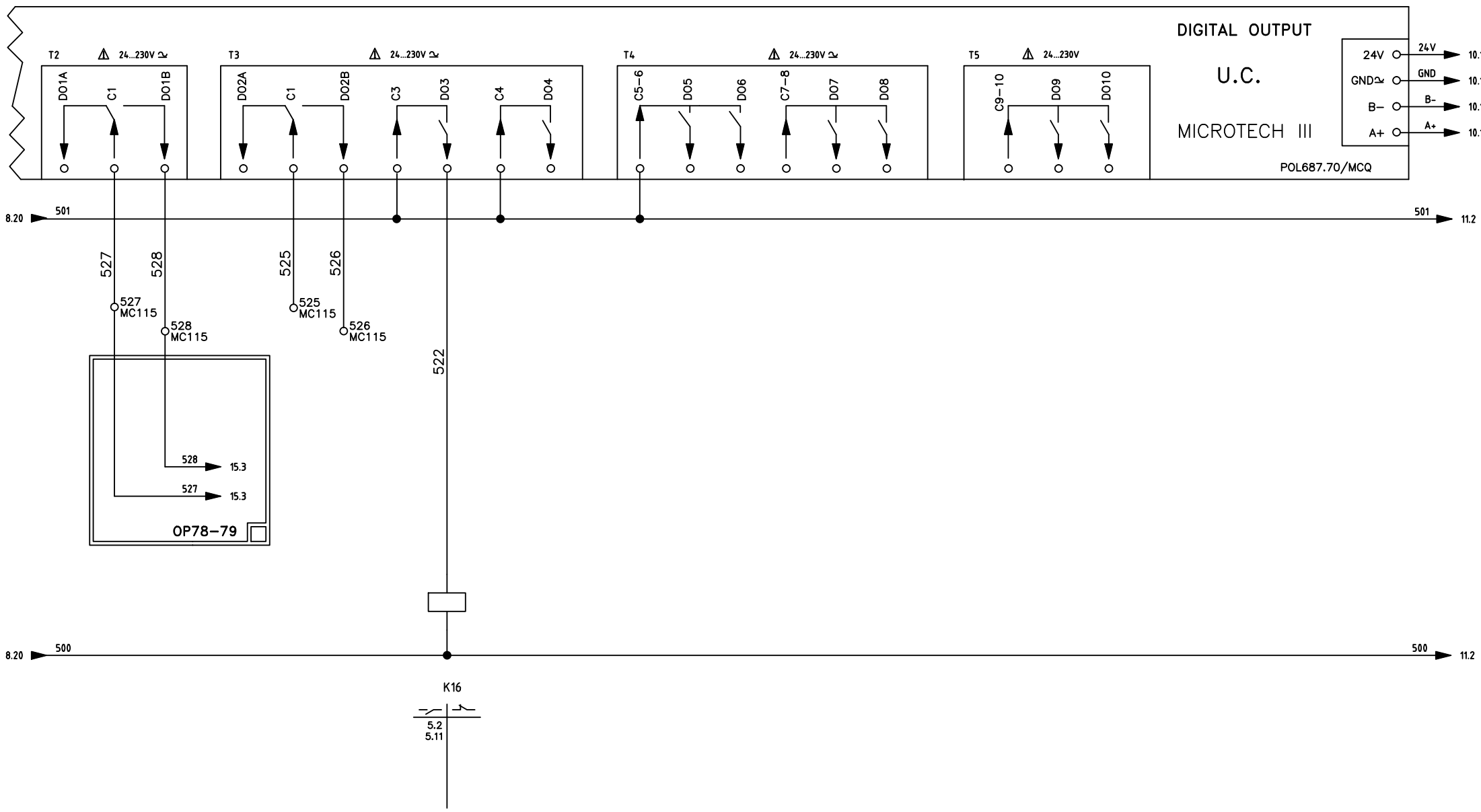

1 | 2 | 3 | 4 | 5 | 6 | 7 | 8 | 9 | 10 | 11 | 12 | 13 | 14 | 15 | 16 | 17 | 18 | 19 | 20

1 | 2 | 3 | 4 | 5 | 6 | 7 | 8 | 9 | 10 | 11 | 12 | 13 | 14 | 15 | 16 | 17 | 18 | 19 | 20

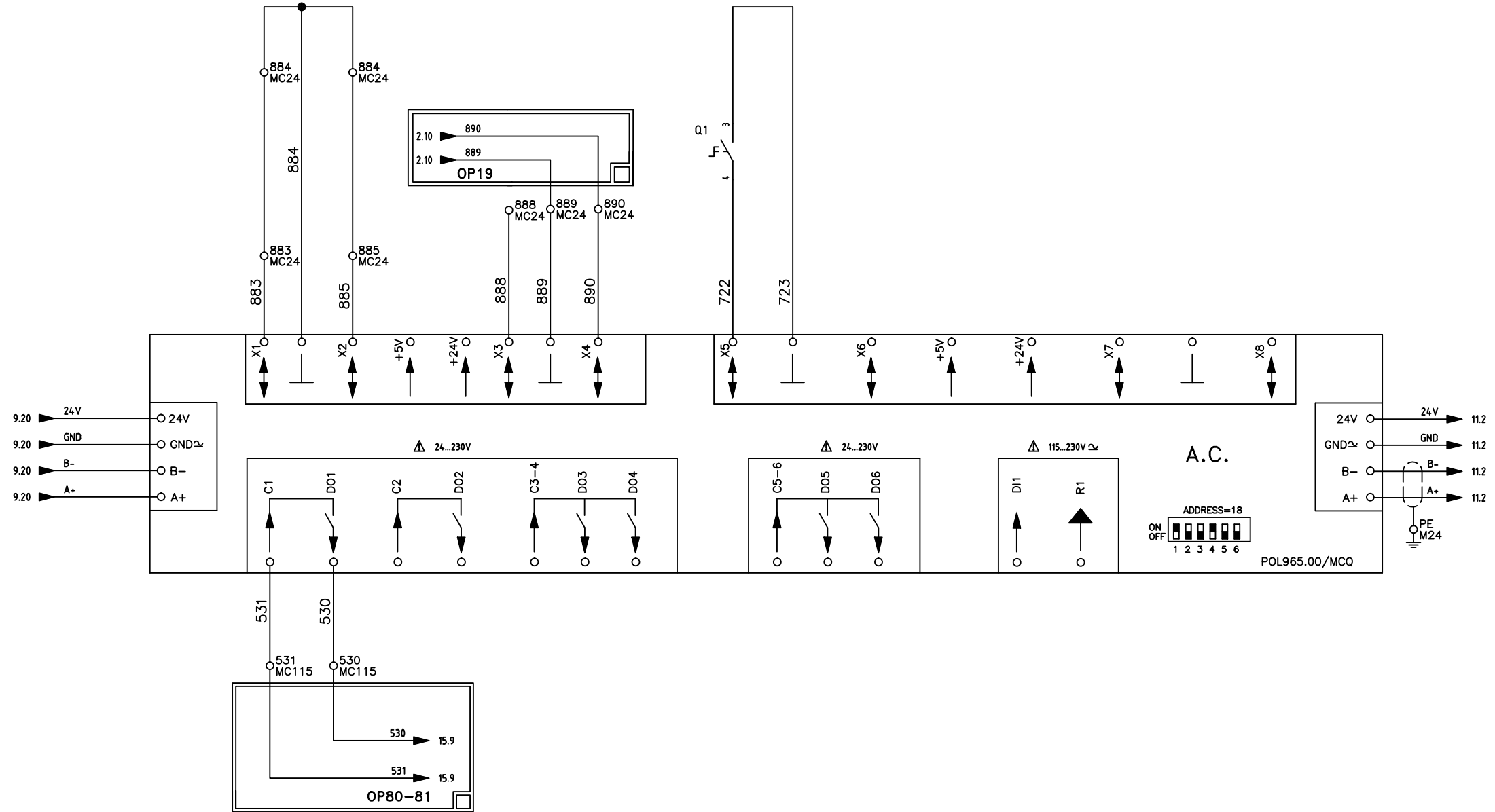

1 | 2 | 3 | 4 | 5 | 6 | 7 | 8 | 9 | 10 | 11 | 12 | 13 | 14 | 15 | 16 | 17 | 18 | 19 | 20

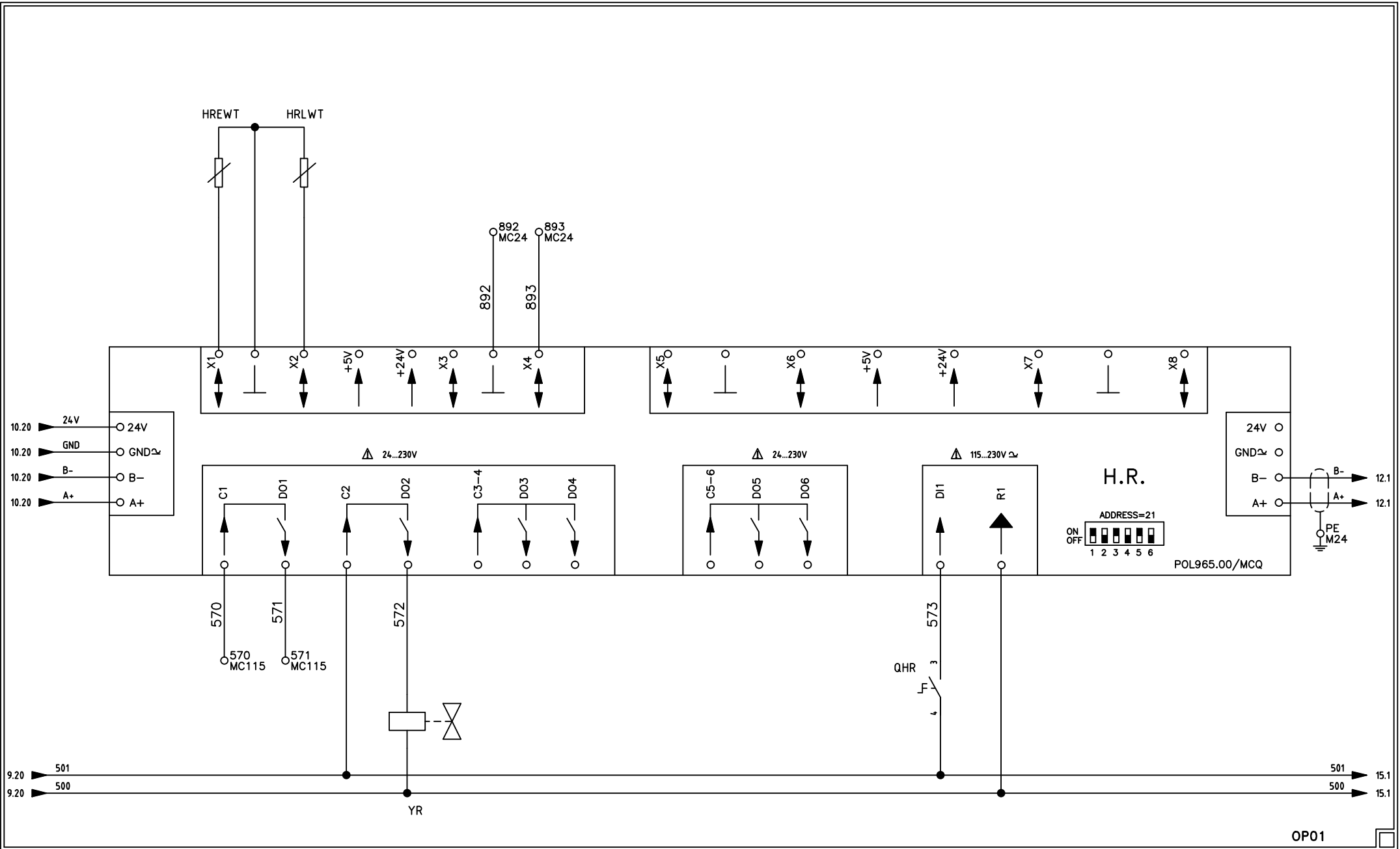

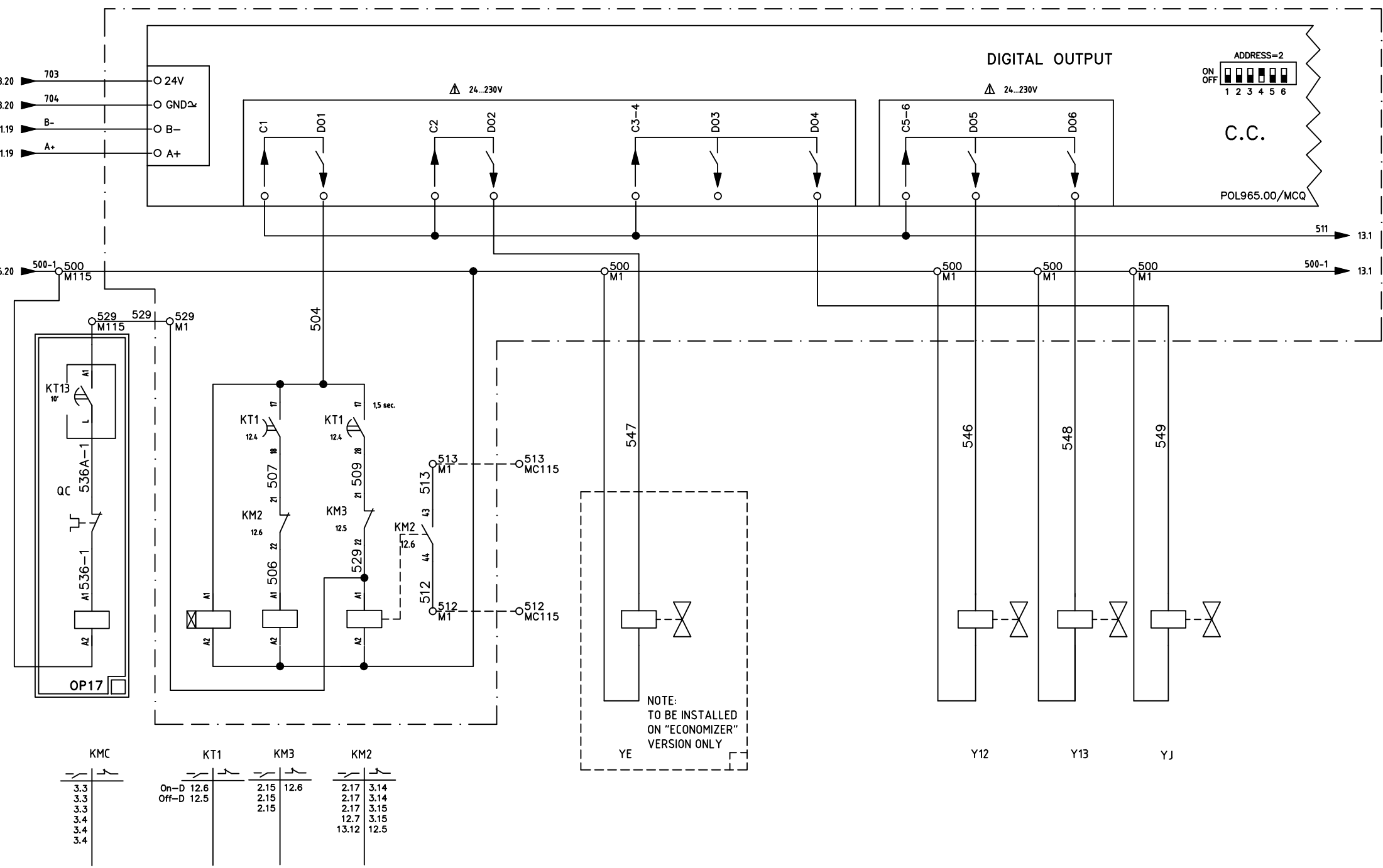

1 | 2 | 3 | 4 | 5 | 6 | 7 | 8 | 9 | 10 | 11 | 12 | 13 | 14 | 15 | 16 | 17 | 18 | 19 | 20

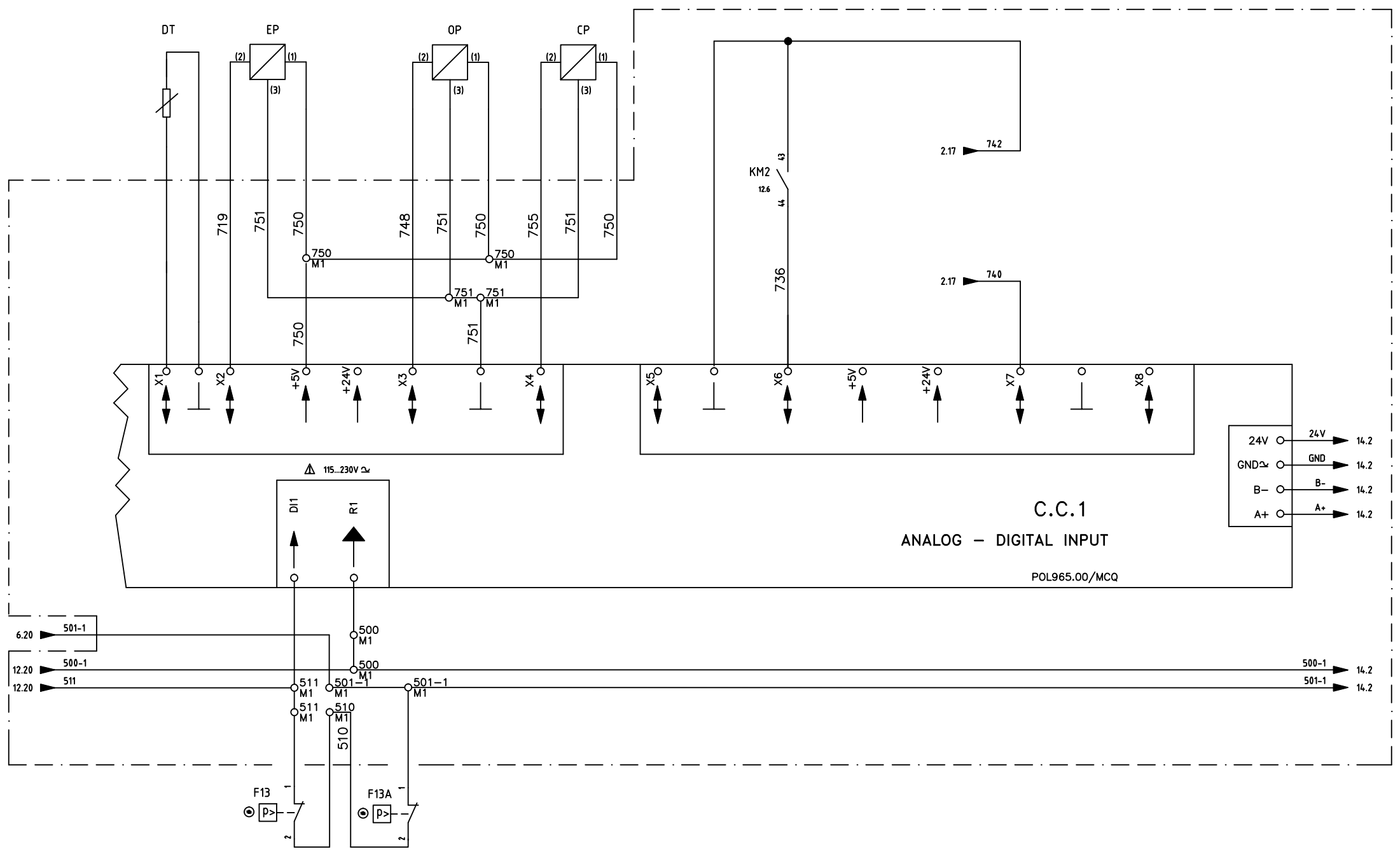

1 | 2 | 3 | 4 | 5 | 6 | 7 | 8 | 9 | 10 | 11 | 12 | 13 | 14 | 15 | 16 | 17 | 18 | 19 | 20

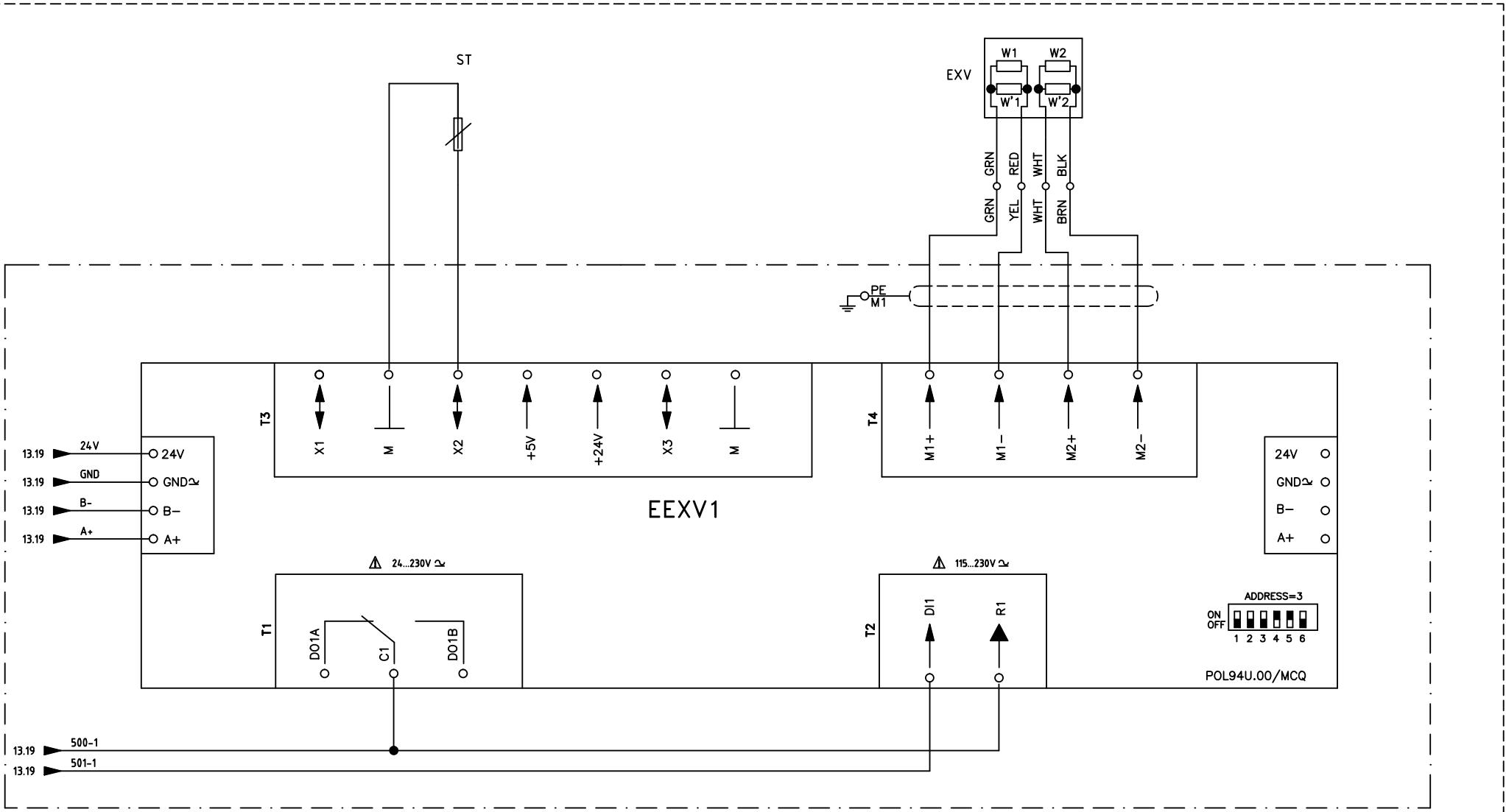

NOTE:
NOT TO BE INSTALLED ON "CU" VERSION

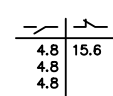
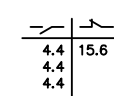
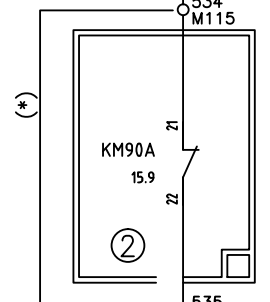
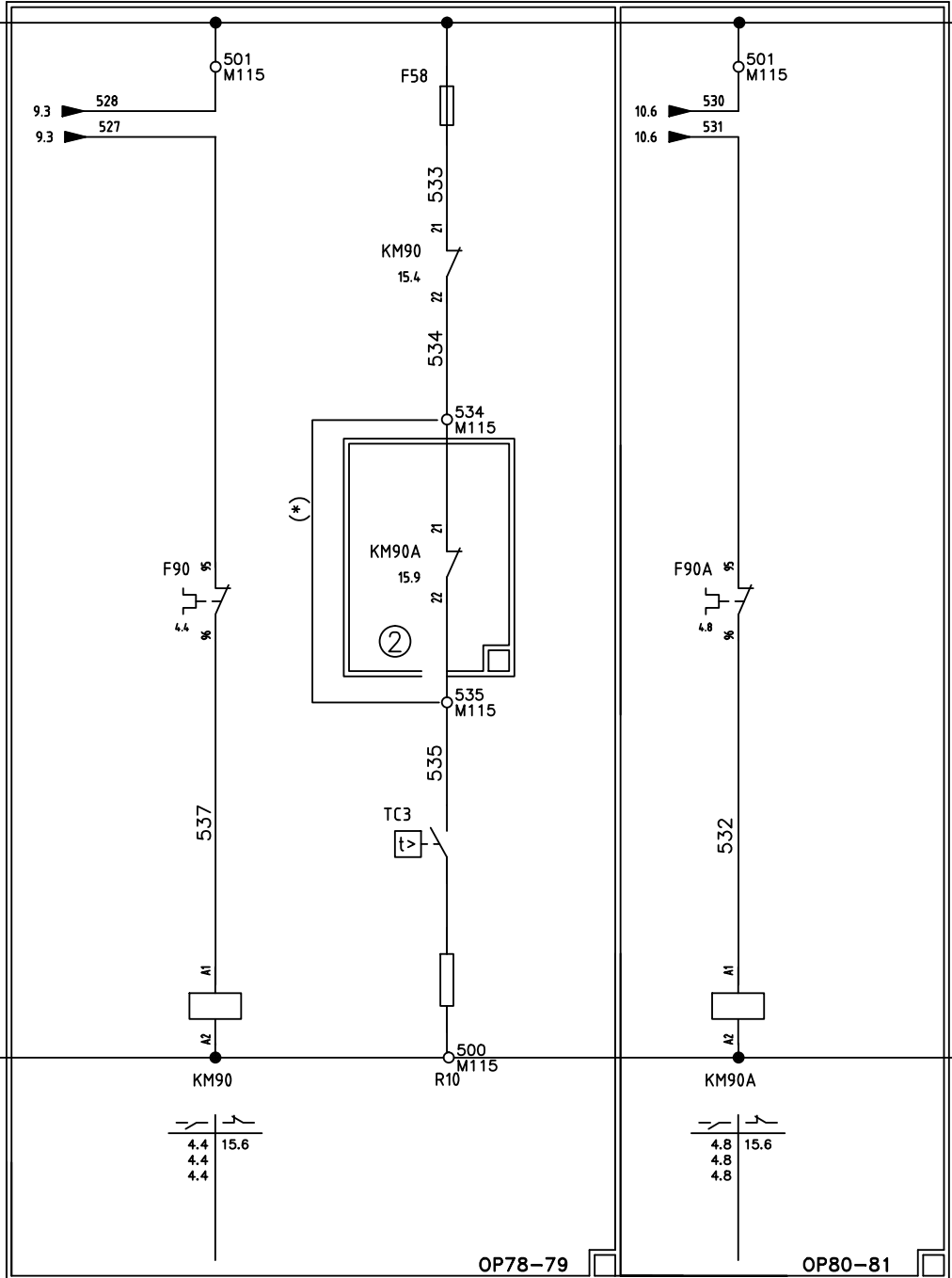
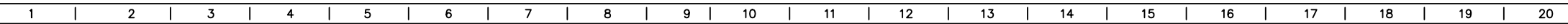
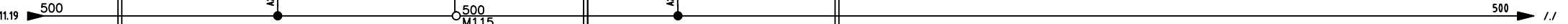
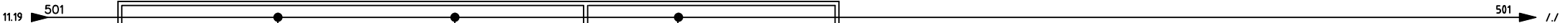
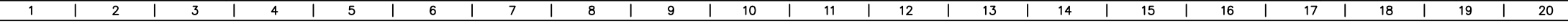

OP78-79

OP80-81

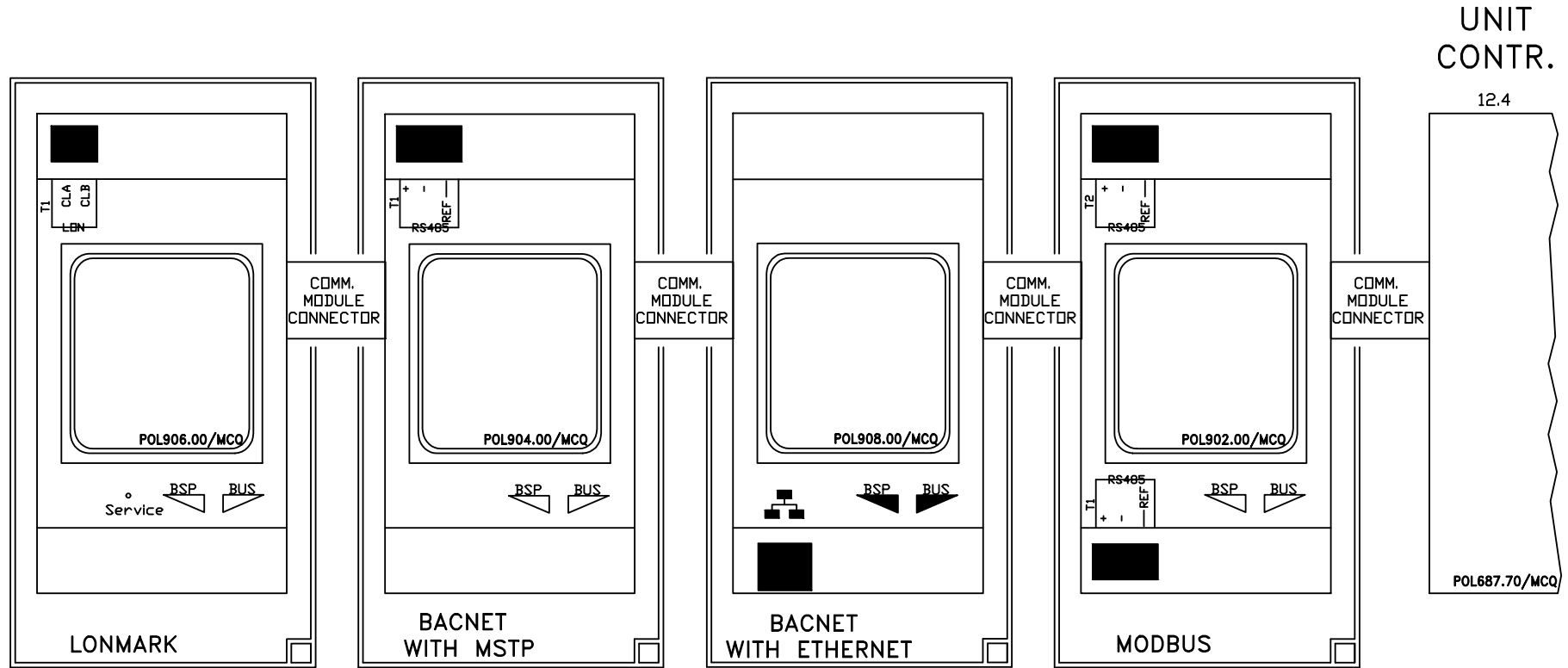

NOTES:

1. ANY OF THESE COMMUNICATION MODULES CAN DIRECTLY CONNECT TO THE LEFT SIDE OF THE UNIT CONTROLLER.
2. COMMUNICATION MODULES CAN CONNECT TO EACH OTHER.

QG - M01

		314
		315
		314
		315
		315

0-U	0-U	0-U
0-V	0-V	0-V
10-U	10-U	10-U
10-V	10-V	10-V
PE	PE	PE

QG	-	M01	400V
QG	-	M01	400V
QG	-	M01	400V
QG	-	M01	400V
QG	-	M01	400V

400V

QG - M1

		129
		1214
		1215
		1217
		186
		186
		185
		186
		185
		185
		127
		127
		123

500-1	500	500-1
500-1	500	500-1
500-1	500	500-1
500-1	500	500-1
500-1	500	500-1
500-1	500	500-1
501-1	501-1	501-1
501-1	501-1	501-1
510	510	510
511	511	511
511	511	511
512	512	512
513	513	513
529	529	529

QG	-	M1	115V
QG	-	M1	115V
QG	-	M1	115V
QG	-	M1	115V
QG	-	M1	115V
QG	-	M1	115V
QG	-	M1	115V
QG	-	M1	115V
QG	-	M1	115V
QG	-	M1	115V
QG	-	M1	115V
QG	-	M1	115V
QG	-	M1	115V

115V

		216
		216
		216
		185
		188
		187
		187
		1412

740	740	740
741	741	741
742	742	742
750	750	750
750	750	750
751	751	751
751	751	751
SHELDDED	SHELDDED	SHELDDED
PE	PE	PE

QG	-	M1	24V
QG	-	M1	24V
QG	-	M1	24V
QG	-	M1	24V
QG	-	M1	24V
QG	-	M1	24V
QG	-	M1	24V
QG	-	M1	24V
QG	-	M1	24V
QG	-	M1	24V

24V

1 | 2 | 3 | 4 | 5 | 6 | 7 | 8 | 9 | 10 | 11 | 12 | 13 | 14 | 15 | 16 | 17 | 18 | 19 | 20

QG - MC115

QG	-	MC115	115V	512	512	512	128
QG	-	MC115	115V	513	513	513	128
QG	-	MC115	115V	525	525	525	95
QG	-	MC115	115V	526	526	526	95
QG	-	MC115	115V	527	527	527	92
QG	-	MC115	115V	528	528	528	93
QG	-	MC115	115V	530	530	530	105
QG	-	MC115	115V	531	531	531	104
QG	-	MC115	115V	570	570	570	114
QG	-	MC115	115V	571	571	571	115

115V

QG - MC24

QG	-	MC24	24V	746	746	746	88
QG	-	MC24	24V	747	747	747	810
QG	-	MC24	24V	708	708	708	87
QG	-	MC24	24V	724	724	724	87
QG	-	MC24	24V	728	728	728	88
QG	-	MC24	24V	745	745	745	810
QG	-	MC24	24V	883	883	883	104
QG	-	MC24	24V	883	883	883	104
QG	-	MC24	24V	885	885	885	105
QG	-	MC24	24V	885	885	885	105
QG	-	MC24	24V	88	886	886	713
QG	-	MC24	24V	887	887	887	713
QG	-	MC24	24V	888	888	888	107
QG	-	MC24	24V	889	889	889	108
QG	-	MC24	24V	890	890	890	109
QG	-	MC24	24V	892	892	892	118
QG	-	MC24	24V	893	893	893	118

24V

1 | 2 | 3 | 4 | 5 | 6 | 7 | 8 | 9 | 10 | 11 | 12 | 13 | 14 | 15 | 16 | 17 | 18 | 19 | 20

ITEM	DESCRIPTION	SHEET	Q.ty
A.C.	ALARM CONTROL	10	1
A/V	ENERGY METER	2	1
C1	POWER FACTOR CORRECTION	3	1
C.C.	CONTROL COMPRESSOR (SIEMENS)	12	1
CF	CONTROL FUSES	23	1
CP	CONDENSER PRESSURE TRANSDUCER	13	1
DT	DISCHARGE TEMP. SENSOR (PT1000)	13	1
EEWT	EVAPORATOR ENTERING WATER TEMPERATURE	7	1
EEXV1	EXPANSION COMPRESSOR 1	14	1
ELWT	EVAPORATOR LEAVING WATER TEMPERATURE	7	1
EP	EVAPORATOR PRESSURE TRANSDUCER	13	1
EXV	ELECTRONIC EXPANSION VALVE	14	1
F0	COMPRESSOR FUSES	3	1
F1	COMPRESSOR FUSES	2	1
F5	THERMAL RELAY	2	1
F9	PUMP FUSES 1	4	1
F9A	PUMP FUSES 2	4	1
F10	TERMOSTAT	6	1
F13	MECH. HIGH PRESSURE SWITCH	13	1
F13A	MECH. HIGH PRESSURE SWITCH	13	1
F58	PUMP HEATER FUSE	15	1
F59	Fusibile unipolare	6	1
F59-1	PROTECTION FUSE	6	1
F60	PROTECTION FUSE	6	1
F90	THERMAL RELAY PUMP 1	4	1
F90A	THERMAL RELAY PUMP 2	4	1
F100	FAN FUSES	5	1
F112	PHASE VOLT MONITOR	6	1
F112A	PHASE VOLT MONITOR	6	1
F130	PHASE VOLT MONITOR FUSE	6	1
F130A	PHASE VOLT MONITOR FUSE	6	1
F140	PHASE VOLT MONITOR FUSE	2	1
FC1	POWER FACTOR CORRECTION FUSES 1	3	1
FVD1	FAN SPEED MODULATION	5	1
FVD2	FAN SPEED MODULATION	5	1
H.R.	HEAT RECOVERY CONTROL BOARD	11	1
K16	FAN MOTOR CONTACTOR	9	1
KM2	CONTACTOR	12	1
KM3	CONTACTOR	12	1
KM90	FIRST PUMP CONTACTOR	15	1
KM90A	FIRST PUMP CONTACTOR	15	1
KMC	POWER FACTOR CORRECTION CONTACTORS	12	1
KT1	DELAY RELAY	12	1
KT13	TIME DELAY RELAY	12	1
M1	COMPRESSOR 1	2	1

ITEM	DESCRIPTION	SHEET	Q.ty
M10	FORCED VENTILATION FAN MOTOR	6	1
M101	FAN MOTOR	5	1
M102	FAN MOTOR	5	1
M103	FAN MOTOR	5	1
M104	FAN MOTOR	5	1
OAT	OUTSIDE AIR TEMPERATURE	7	1
OP	OIL PRESSURE TRANSDUCER	13	1
OP01	TOTAL HEAT RECOVERY	11	1
OP11	THERMAL RELAY	2	1
OP13	UNDER/OVER VOLTAGE CONTROL	6	1
OP16	A/V METER	2	1
OP17	POWER FACTOR CORRECTION	3	1
OP19	CURRENT LIMIT	2	1
OP78-79	ONE CENTRIFUGAL PUMP	4	1
OP80-81	TWO CENTRIFUGAL PUMP	4	1
P1	PUMP 1	4	1
P2	PUMP 2	4	1
Q0	UNIT ON - OFF	8	1
Q1	CIRCUIT SWITCH 1	10	1
Q10	MAIN SWITCH	2	1
Q12	AUTOMATIC CIRCUIT BREAKER	6	1
QC1	THERMAL RELAY	3	1
QHR	HEAT RECOVERY SWITCH	11	1
R1	COMPRESSOR CRANKCASE HEATER CIRC.1	3	1
R5	EVAPORATOR HEATER (EXCEPT CONDENSING UNITS)	6	1
R10	PUMP HEATER (100W)	15	1
SC	CURRENT LIMIT	2	1
SCA	STANDARD CAPACITOR	23	1
SC0	STANDARD COMPRESSOR	23	1
SF	STANDARD FAN	23	1
SP	STANDARD PUMPS	23	1
ST	SUCTION TEMPERATURE SENSOR 1	14	1
STD	STANDARD FAN	23	1
T1	400/115V TRANSFORMER	6	1
T2	115/24V TRANSFORMER	6	1
TA1	AMMETER TRANSFORMER	2	1
TA3	AMMETER TRANSFORMER	2	1
TA4	AMMETER TRANSFORMER	2	1
TC3	TERMOSTAT (CLOSED=5°C)	15	1
TRAFO	TRANSFORMER	23	1
Tc5	TERMOSTAT	6	1
U.C.	UNIT CONTROL	7	1
W1	COMPRESSOR THERMISTOR CIRC. 1	2	1
Y12	LOADER SOL. VALVE	12	1
Y13	UNLOADER SOL. VALVE	12	1

ITEM	DESCRIPTION	SHEET	Q.ty
YE	ECONOMIZER SOLENOID VALVE (ECONOMIZER UNITS ONLY)	12	1
YJ	LIQUID INJECTION SOLENOID VALVE	12	1
YR	RECOVERY SUBCOOLING SOLENOID VALVE	11	1

SCO = Standard Compressor Fuse + Overcurrent					
ITEM	3118-R134a	3120-R134a	3121-R134a	3122-R134a	3123-R134a
	HSS3118	HSS3120	HSS3121	HSS3122	HSS3123
F1,F2,F3	100 A gG NH00	125 A gG NH00	125 A gG NH00	160 A gG NH00	200 A gG NH1
F5-1,2,3	Set (OP11) 49 A	58 A	65 A	74 A	88 A
F1,F2,F3	Set (OP95) 84 A	101 A	112 A	127 A	152 A

SP=Standard pump fuses + overcurrent					
ITEM	1,5 kW	2,2 kW	3 kW	4 kW	5,5 kW
F9	20 A	20 A	20 A	20 A	20 A
F9A	20 A	20 A	20 A	20 A	20 A
F70	3,5 A	5 A	6,5 A	8,5 A	11 A
F80	3,5 A	5 A	6,5 A	8,5 A	11 A

TRAFO=Transformer size	
ITEM	
T1	500 VA
T2	200 VA

CF=Control fuses+size	
ITEM	
F0	2 A
Q12	4 A
F130	4 A
F130A	4 A
F59	2 A
F59A	2 A
F60	2 A

Option	Description
OP01	Total Heat Recovery
OP11	Thermal Relay
OP13	Under/Over Voltage Control
OP16	Energy Meter
OP17	Power Factor Correction
OP19	Current limit/Display
OP78-79	One Centrifugal Pump
OP80-81	Two Centrifugal Pump

OP17 Power Factor Correction - Capacitor + Overcurrent					
ITEM	3118-R134a	3120-R134a	3121-R134a	3122-R134a	3123-R134a
	HSS3118	HSS3120	HSS3121	HSS3122	HSS3123
FC1,2,3	25 A gG E18	25 A gG E18	25 A gG E18	25 A gG E18	35 A gG E18
QC1,2,3	16 A	16 A	16 A	16 A	25 A

SF=Standard fan fuses + overload				STD =Standard			
FAN TYPE	OVERLOAD	1 FAN	2 FAN	FUSES	n° FANS		
					2	3	4
MCDK800-6P	SETTING	4,0 A	8,0 A	F100	10 A	16 A	25 A
MCDK800-8P	SETTING	2,8 A	5,6 A	F100	10 A	16 A	16 A

Digital input terminals

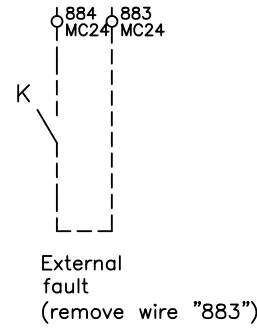
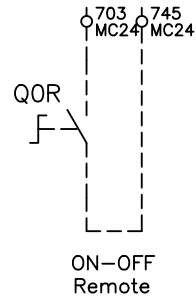
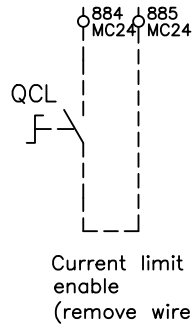
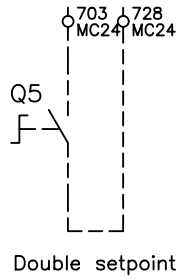
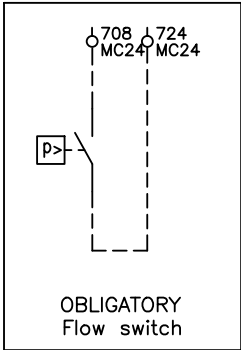

Analog input terminals

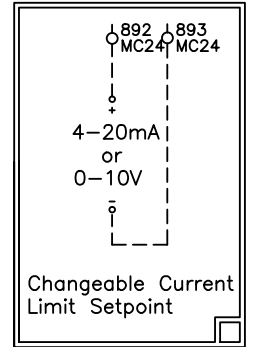
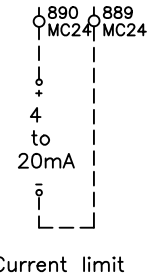
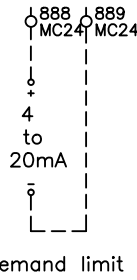
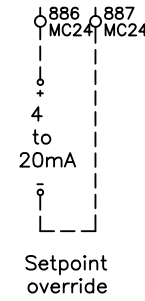

Digital output terminals

