

EHBH-E6V
EHBH-E9W
EHBX-E6V
EHBX-E9W

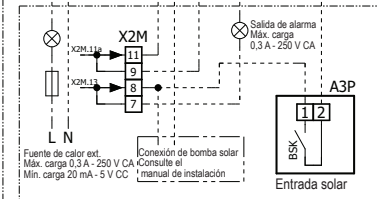

Opciones: salida de fuente de calor ext., salida de alarma

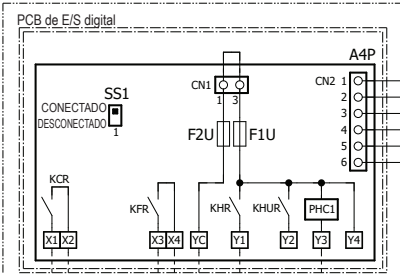
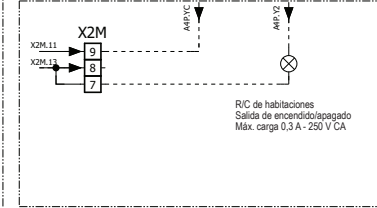

Opciones: Salida de encendido/apagado

Solo para la opción de PCB de E/S digital

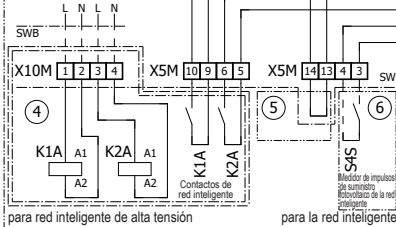

para red inteligente de alta tensión

para la red inteligente

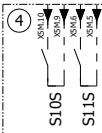

para red inteligente de baja tensión

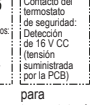
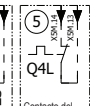
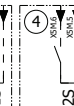
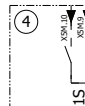

para termostato de seguridad

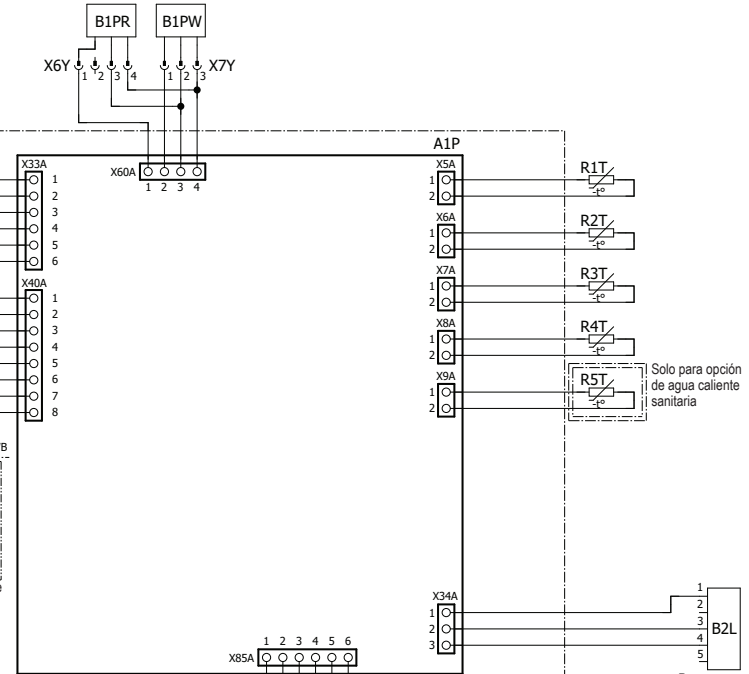

Solo para opción de agua caliente sanitaria

Para sensor de caudal de tipo impulsos

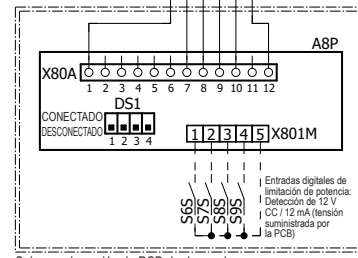

Solo para la opción de PCB de demanda