

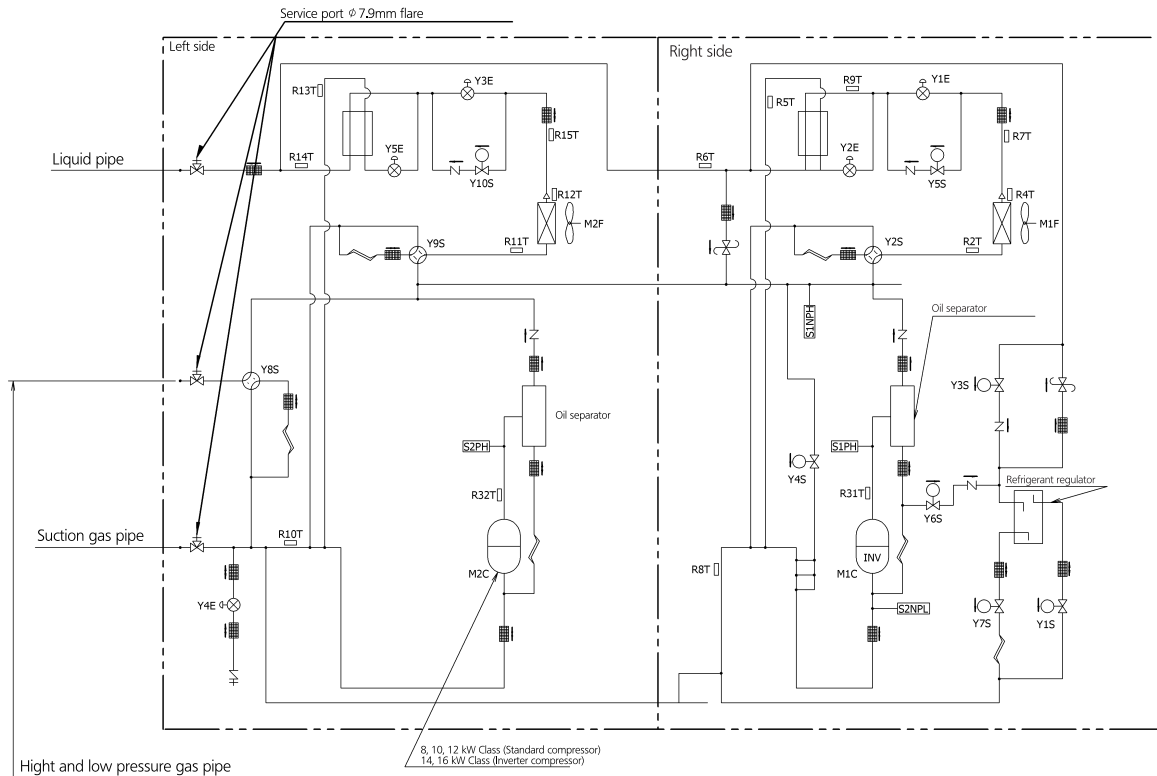



EMRQ-A

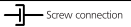
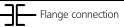

8, 10, 12 kW Class (Standard compressor)
14, 16 kW Class (Inverter compressor)

 Check valve	 Flare connection	 Screw connection	 Flange connection	 Pinched pipe	 Spinned pipe
---	---	---	--	---	---