

# EKHVMYD-A

## Detail A Scale 1/3

If required (e.g. Wall fixation)  
Pressure gauge can be removed from waterfilter, maximum  
distance between waterfilter and pressure gauge +/- 600mm

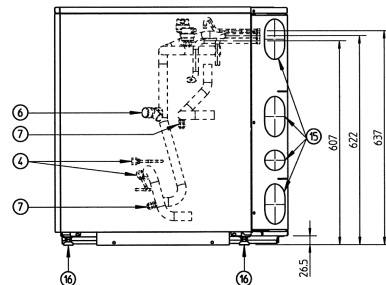
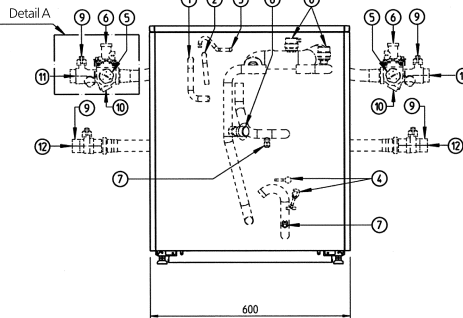
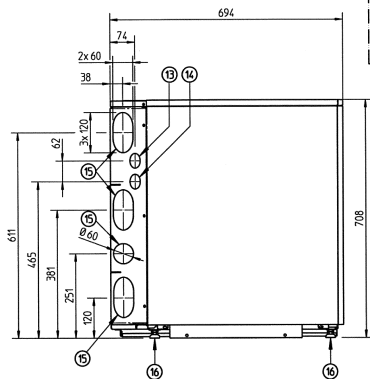
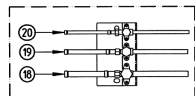
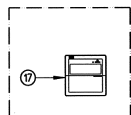
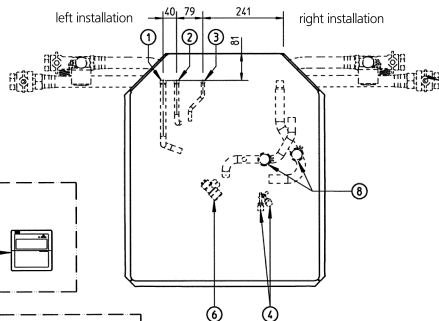
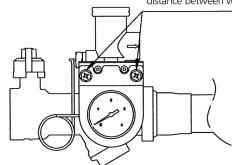

- 1 Suction/gas pipe connection  $\phi$  15,9 Solder (R410A)
- 2 Discharge/gas pipe connection  $\phi$  12.7 Solder (R410A)
- 3 Liquid pipe connection  $\phi$  9.5 Solder (R410A)
- 4 R134a Service ports 5/16" flare (2x)
- 5 Pressure gauge
- 6 Blow off valve (2x)
- 7 Drain water circuit 5/16" SAE (2x)
- 8 Air purge (2x)
- 9 Shut-off valves (2x)
- 10 Water filter
- 11 Water in connection G 1" (Female)
- 12 Water out connection G 1" (Female)
- 13 Control wiring intake (Knock out hole  $\phi$  37)
- 14 Power supply wiring intake (Knock out hole  $\phi$  37)
- 15 Knock-out holes for refrigerant piping and water piping
- 16 Levelling feet
- 17 Remote controller (delivered as accessory)  
Installation location is outside the unit
- 18 Suction/gas stop valve  $\phi$  15,9 Solder (R410A)
- 19 Discharge/gas stop valve  $\phi$  12,7 Solder (R410A)
- 20 Liquid stop valve  $\phi$  9,5 Solder (R410A)