

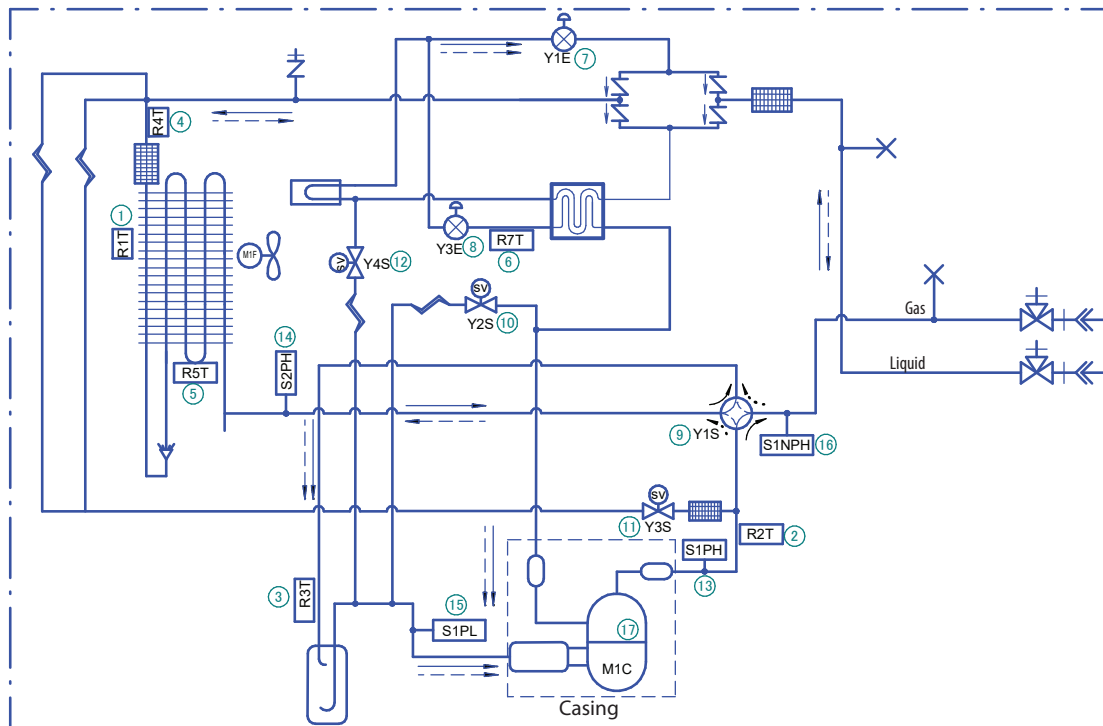



















ERRA-EV37 ERRA-EW17



Outdoor unit



LEGEND

-  PCB
-  Electronic expansion valve
-  Check valve
-  Filter
-  Economiser
-  Solenoid valve
-  Fan motor
-  Stop valve
-  Accumulator
-  Pinched pipe
-  Compressor
-  Service port ·5/16"· flare
-  Pressure sensor
-  Muffler
-  High pressure switch
-  High pressure switch
-  Capillary tube
-  4-way valve
-  Heating
-  Cooling

①	R1T	Ambient thermistor
②	R2T	Thermistor (discharge)
③	R3T	Thermistor (suction)
④	R4T	Thermistor (heat exchanger, liquid pipe)
⑤	R5T	Thermistor (heat exchanger middle)
⑥	R7T	Thermistor (injection)
⑦	Y1E	Electronic expansion valve (main)
⑧	Y3E	Electronic expansion valve (injection)
⑨	Y1S	Solenoid valve (4-way valve)
⑩	Y2S	Solenoid valve (low pressure bypass)

⑪	Y3S	Solenoid valve (hot gas pass)
⑫	Y4S	Solenoid valve (liquid injection)
⑬	S1PH	High pressure switch ·4.6MPa·
⑭	S2PH	High pressure switch ·4.17MPa·
⑮	S1PL	Low pressure switch
⑯	S1NPH	High pressure sensor
⑰	Q1E	Overload protector
		Brazed connection
		Flare connection

3D142205B