

UATYA20-30BFC2Y1

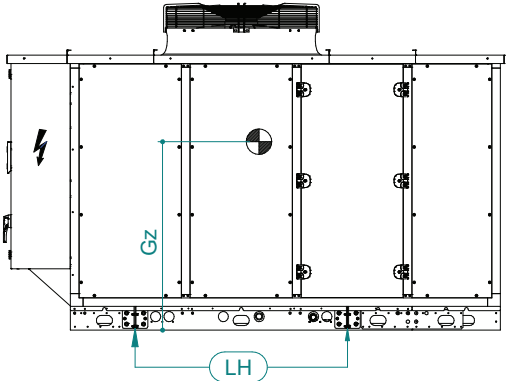

Fh	Fixing holes	Ø22	LH	Lifting point	G..	Vibration damper foot holds
----	--------------	-----	----	---------------	-----	-----------------------------

Model	Weight (kg)						(mm)		
	Shipping	Operating	G1	G2	G3	G4	Gx	Gy	Gz
UATYA25BFC2Y1	1010	981	262	245	229	245	1051	1065	823
UATYA30BFC2Y1	1043	1014	265	245	242	262	1041	1028	867

Model	Rubber anti-vibration mounts				Boxes to be ordered *
	G1	G2	G3	G4	
UATYA25BFC2Y1	UATYAAVM1	UATYAAVM1	UATYAAVM1	UATYAAVM1	2 x UATYAAVM1
UATYA30BFC2Y1	UATYAAVM1	UATYAAVM1	UATYAAVM1	UATYAAVM1	2 x UATYAAVM1

* Each box contains 2 mounts

