

3MXM68A

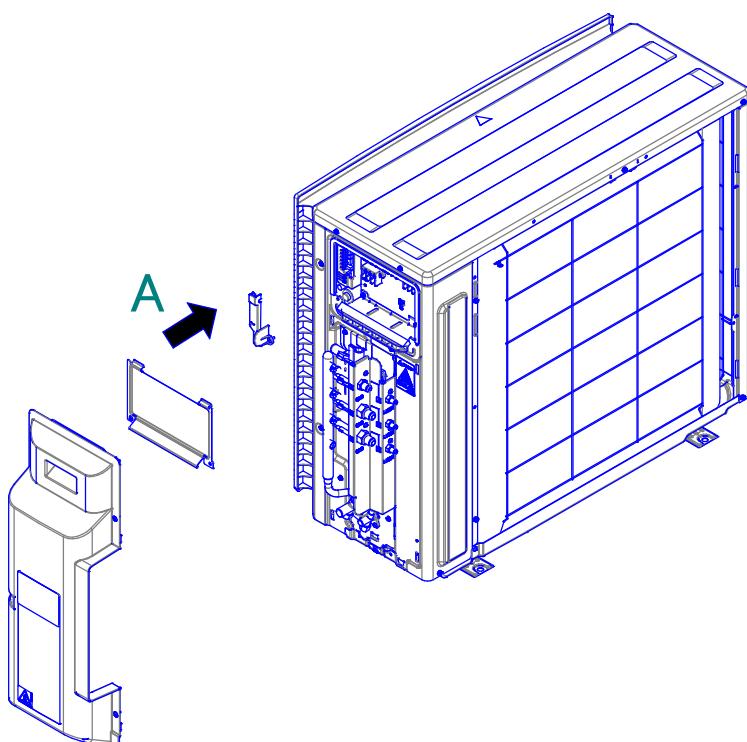

DISASSEMBLY OF UNIT

SWICH SW6-2 TO "ON" POSITION

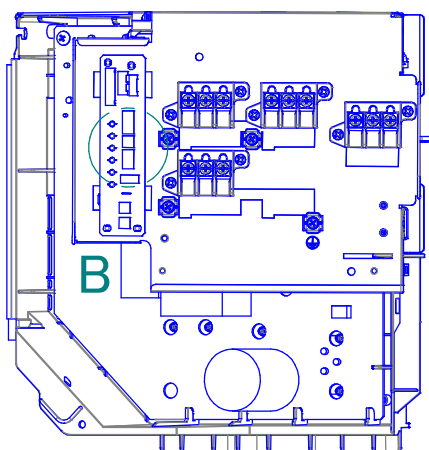

ARROW VIEW A
EL. COMPO. ASSY

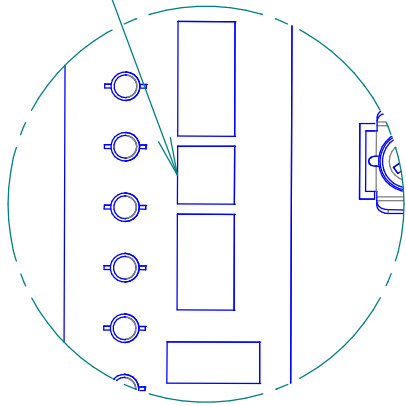

DETAIL B