

2MXM68A

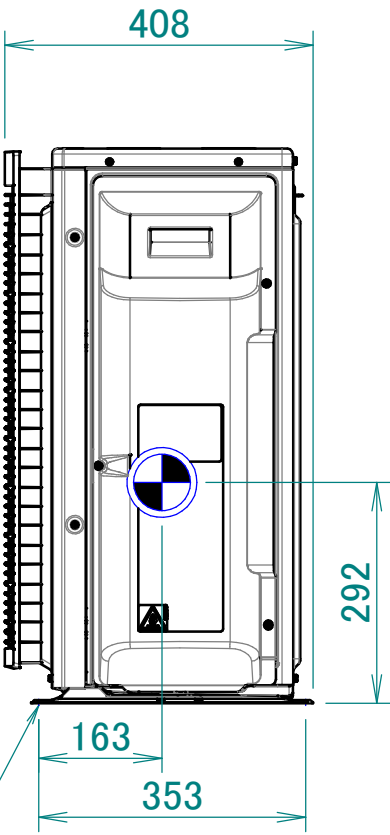
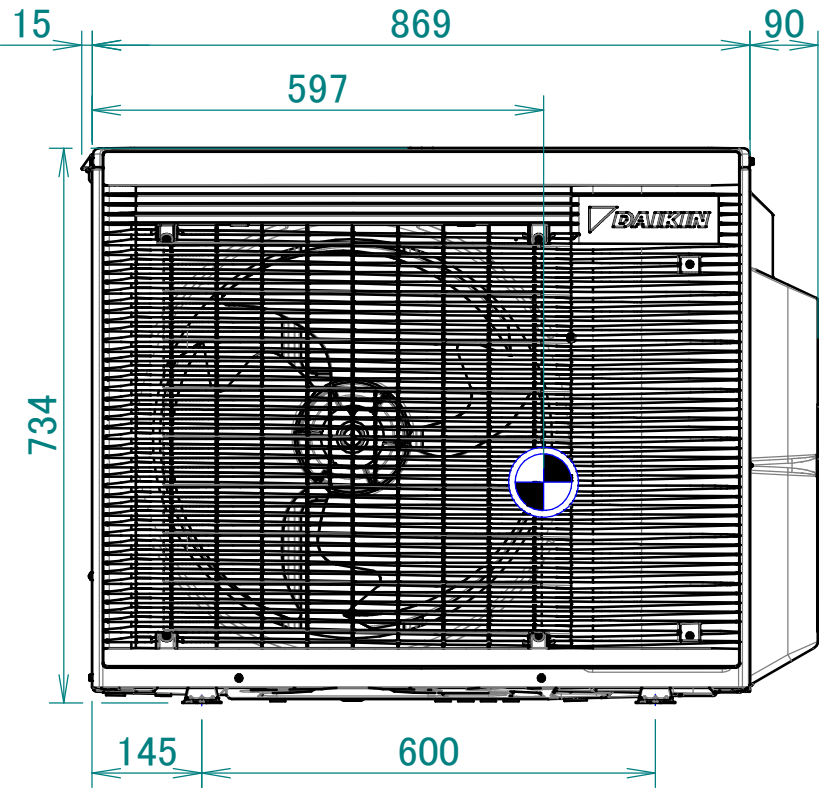

Orificio de pernos para base

4D139754