

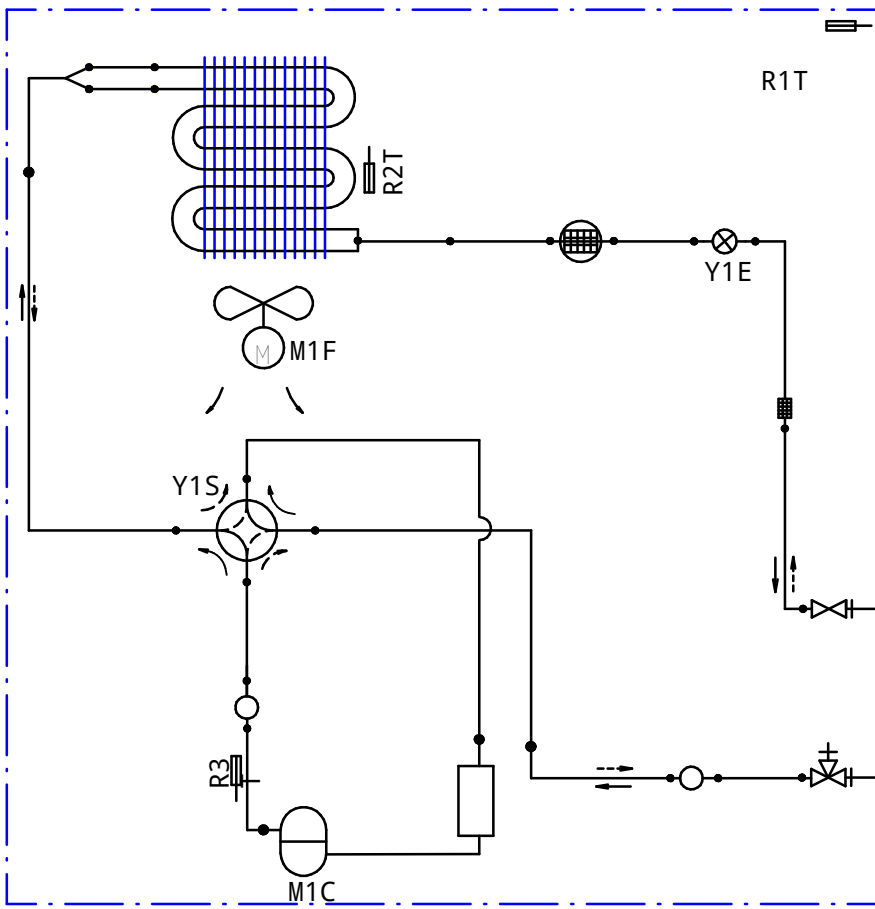











ARXQ25A

RXQ25A

Outdoor unit



-  Liquid stop valve
-  Gas stop valve
-  Muffler
-  Muffler with filter
-  Electronic expansion valve
-  Propeller fan
-  Thermistor
-  4-way valve
-  Accumulator
-  Compressor
-  Heat exchanger

Field piping

·6.4· CuT

Field piping

·9.5· CuT

Refrigerant flow

→ Cooling

- - -> Heating

3D136838