

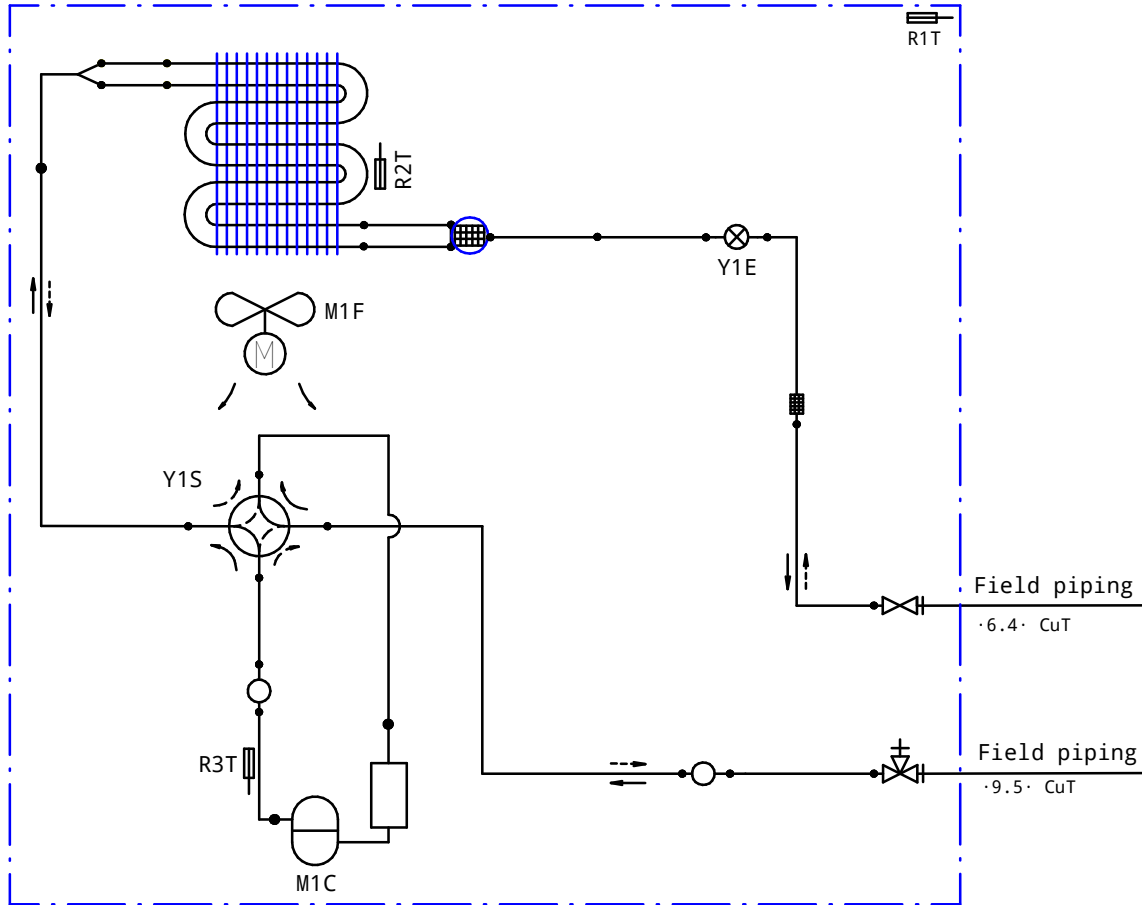













# ARQX35A RXQ35A

Outdoor unit



-  Liquid stop valve
-  Gas stop valve
-  Muffler
-  Muffler with filter
-  Electronic expansion valve
-  Propeller fan
-  Thermistor
-  4-way valve
-  Accumulator
-  Compressor
-  Heat exchanger

Refrigerant flow

-  Cooling
-  Heating