

FXCQ20-40A

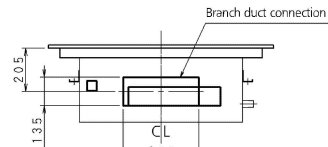

B View

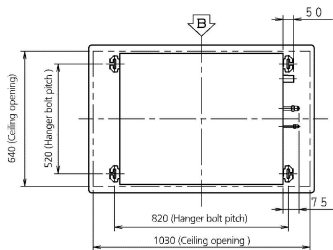
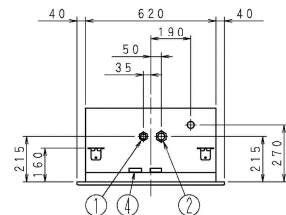
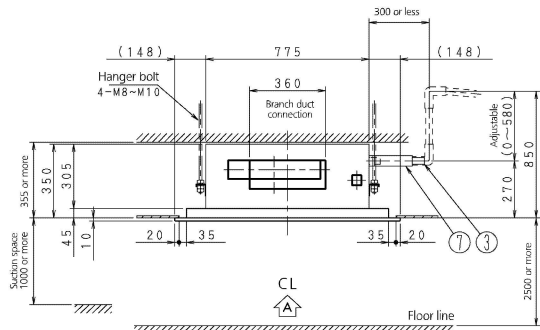
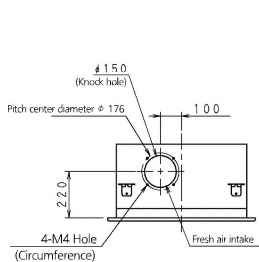

Required space

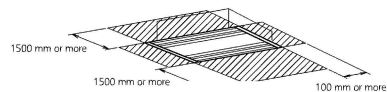

Notes:

- Sticking location for manufacturer's label
 Manufacturer's label for indoor unit:
 Suction panel inner side's control box lid surface
 Manufacturer's label for decoration panel:
 Suction panel inner side's panel frame surface
- When installing an optional accessory, refer to the installation drawings.
- In case of using infrared remote controller, this position will be a signal receiver. Refer to the drawing of infrared remote controller in detail.
- When the temperature and humidity in the ceiling exceed 30°C and RH 80%, the additional insulation is required.
 Insulation: Thickness 10mm or more, Glass wool or polyethylene foam.
- Please do not place the thing been damp and troubled under an indoor unit. When the case where humidity is 80% or more, and the drain outlet are choked up and the air filter are dirty, dew may fall.

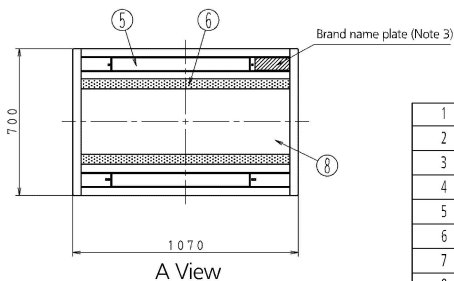

A View

1	Liquid piping connection	φ 6.4mm Flare connection
2	Gas piping connection	φ 12.7mm Flare connection
3	Drain piping connection	VP25 (O.D. φ 32, I.D. φ 25)
4	Wiring penetrating hole	
5	Air outlet	
6	Air inlet	
7	Drain hose (Accessory)	O.D. φ 32 (Main body side connection: O.D. φ 26)
8	Suction panel	