

FXDQ15-32A

Service space of installation box for adaptor PCB.

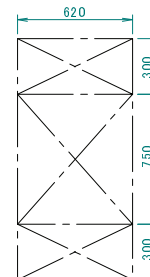

View A - Inspection door Ceiling opening

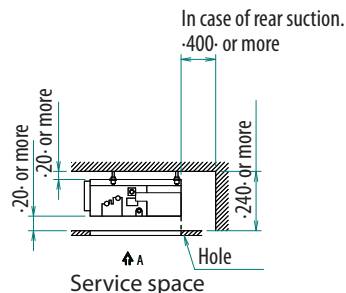
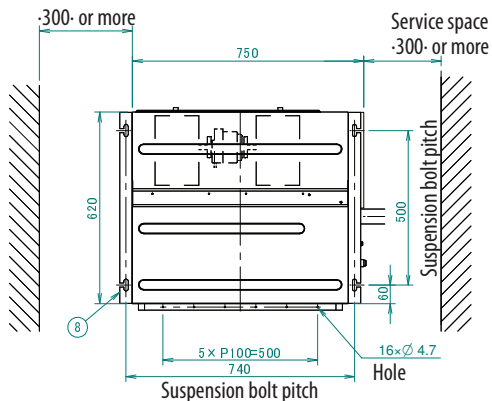
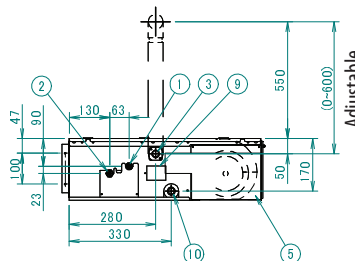
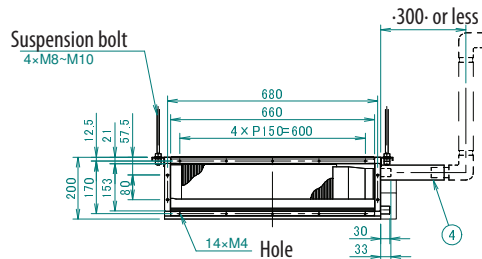

Adjustable

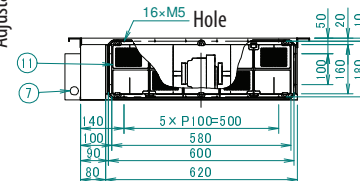

In case of rear suction.

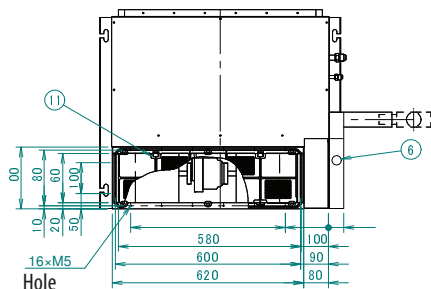

In case of bottom suction.

NOTES

- In case of rear suction, mount the chamber cover to the bottom side of the unit.
In case of bottom suction, mount the chamber cover to the backside of the unit.
- In case of bottom suction, no service space is required at the rear side.
- The unit nameplate is located on the control box cover.
- Mount the air filter at the suction side.
Use an air filter with a dust collecting efficiency of at least 50% (measured by gravimetric analysis).
When a duct is connected at the suction side, it is not possible to mount an air filter.

Item	Name	Description
1	Liquid pipe connection port	Ø 6.4 Flare connection
2	Gas pipe connection port	Ø 12.7 Flare connection
3	Drain pipe connection	VP-20· (ID ·20· x OD ·26·)
4	Drain hose (accessory)	Inside diameter: ·25· Outlet
5	Control box	
6	Transmission wiring connection	
7	Power supply connection	
8	Suspension bracket	
9	Maintenance cover	
10	Drain socket	
11	Air filter (accessory)	

3D081435A