

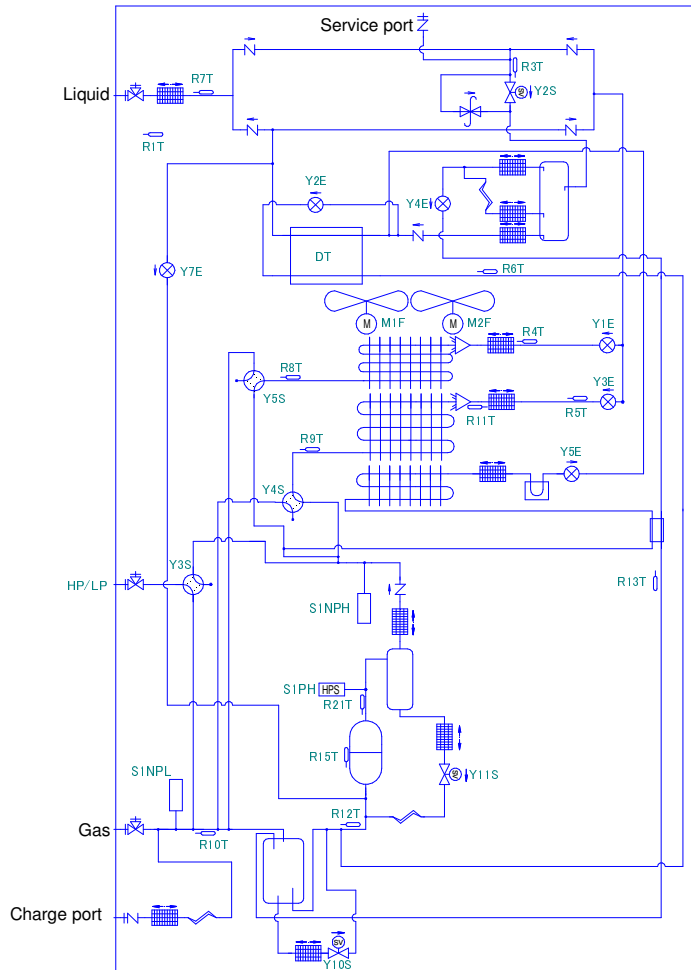





















REYA14-20A



-  · Charge port / Service port
-  · Stop valve
-  · Filter
-  · Check valve
-  · Pressure relief valve
-  · Thermistor
-  · Solenoid valve
-  · Heat sink (FCB)
-  · Capillary tube
-  · Expansion valve
-  · 4-way valve
-  · Propeller fan
-  · High pressure switch
-  · Low pressure sensor
-  · High pressure sensor
-  · Oil separator
-  · Accumulator
-  · Heat exchanger
-  · Compressor
-  · Double tube heat exchanger
-  · Distributor
-  · Liquid receiver