

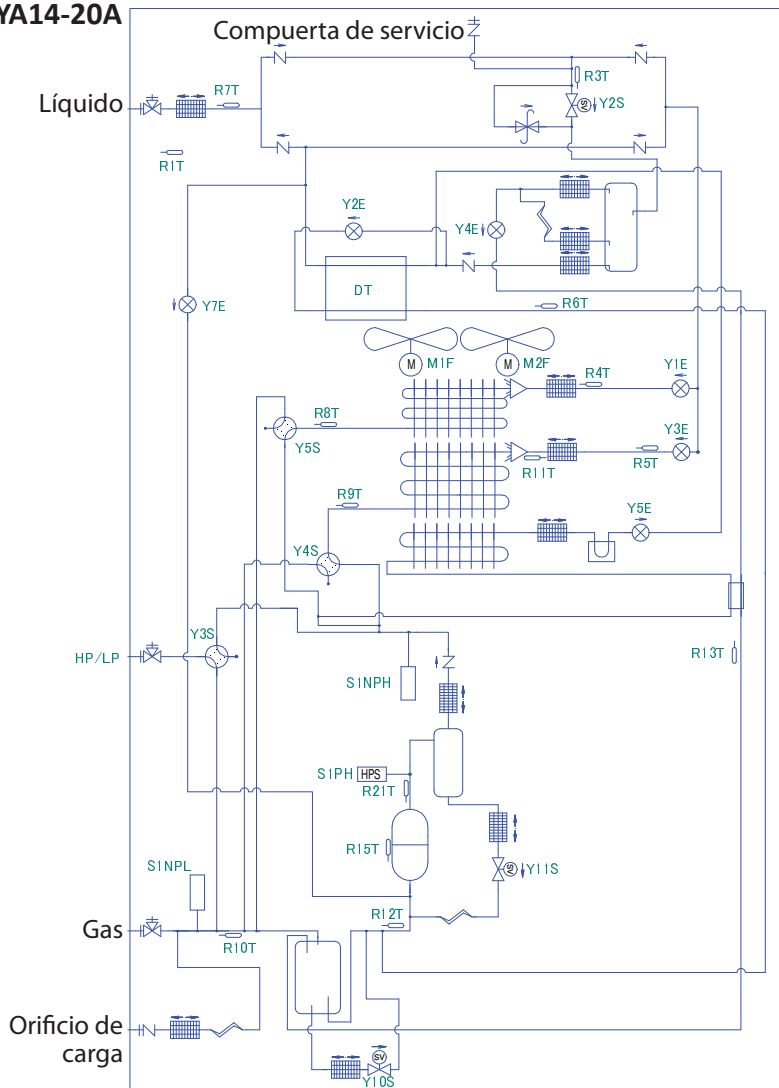





















REYA14-20A



-  Orificio de carga / Compuerta de servicio
-  Válvula de cierre
-  Filtro
-  Válvula de control
-  Válvula de alivio de presión
-  Termistor
-  Válvula solenoide
-  Disipador térmico (PCB)
-  Tubo capilar
-  Válvula de expansión
-  Válvula de 4 vías
-  Ventilador helicoidal
-  Presostato de alta
-  Sensor de baja presión
-  Sensor de alta presión
-  Separador de aceite
-  Acumulador
-  Intercambiador de calor
-  Compresor
-  Intercambiador de calor de placas
-  Distribuidor
-  Receptor de líquido