

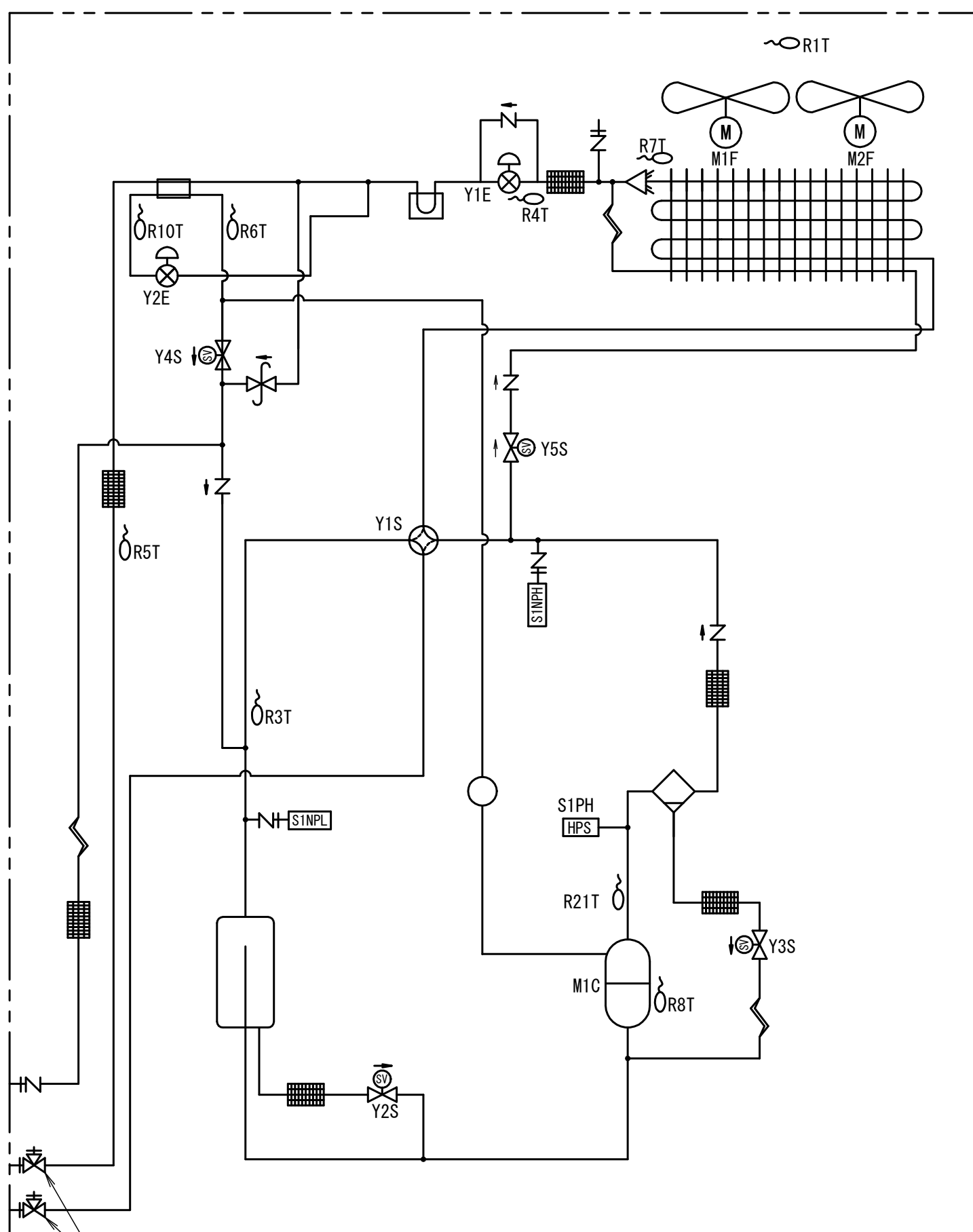

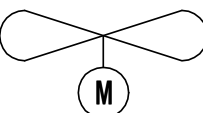

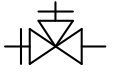

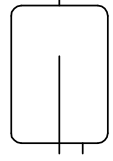

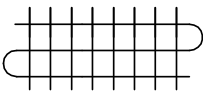
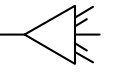
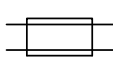

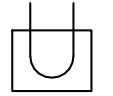
RXMLQ-T

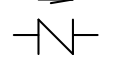
RXYLQ-T

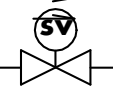

Stop valve with service port

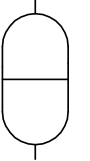
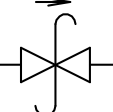
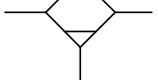
- | | | | | | |
|--|-------------------------------------|---|---------------------------------|---|---|
|  | Ventilador de hélices |  | Válvula de cierre |  | Acumulador |
|  | Intercambiador de calor |  | Distribuidor |  | Intercambiador de calor, subrefrigeración |
|  | Válvula de expansión electrónica |  | PCB Cooling |  | Silenciador |
|  | Válvula de 4 vías |  | Válvula de retención | | |
|  | Puerto de servicio 5/16" abocardado |  | Filtro | | |
|  | Interruptor de alta presión |  | Válvula solenoide | | |
|  | Interruptor de baja presión |  | Tubo capilar | | |
|  | Compresor |  | Válvula de alivio de la presión | | |
|  | Separador de aceite | | | | |
-
- | | |
|-------|---|
| R1T: | Termistor (aire) |
| R21T: | Termistor (descarga) |
| R3T: | Termistor (succión) |
| R4T: | Termistor (intercambiador de calor, liquido, principal) |
| R5T: | Termistor (intercambiador de calor, subrefrigeración, líquido) |
| R6T: | Termistor (intercambiador de calor, subrefrigeración, gas) |
| R7T: | Termistor (intercambiador de calor, descongelador) Termistor |
| R8T: | (cuerpo del compresor) |
| R10T: | Termistor Entrada del intercambiador de calor de subrefrigeración |