

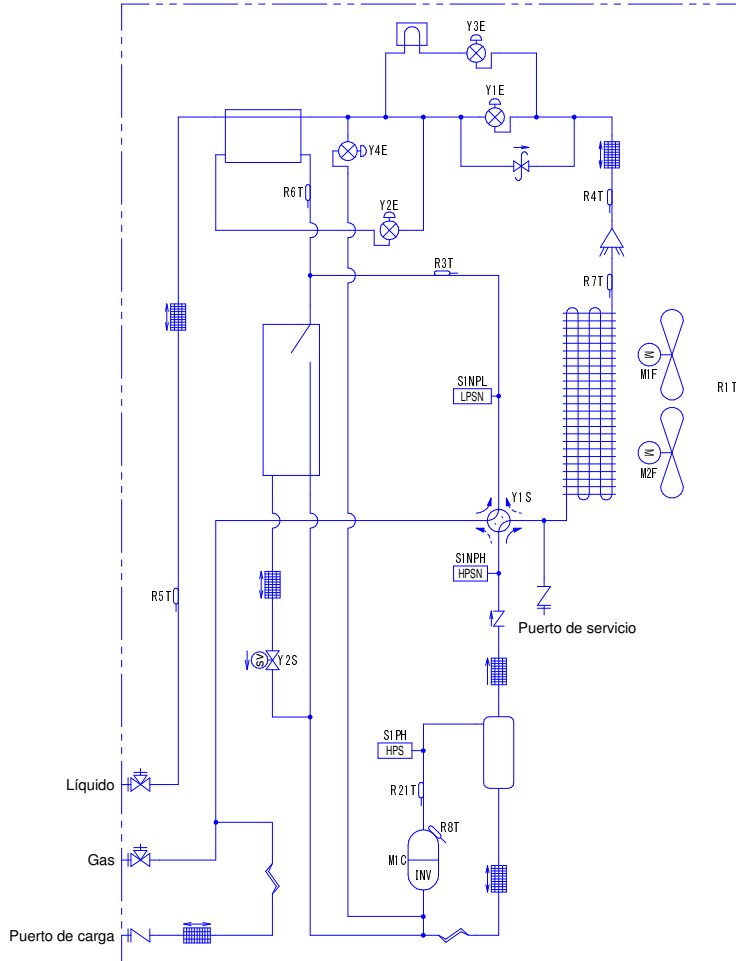









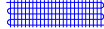













RXYS10-12AY1



Designación

-  Puerto de carga / Puerto de servicio
-  Intercambiador de calor
-  Válvula de expansión (tipo electrónico)
-  Ventilador de hélices
-  Separador de aceite
-  Intercambiador de calor de doble tubo
-  Interruptor de alta presión
-  Válvula de alivio de la presión
-  Disipador de calor
-  Filtro
-  Válvula de 4 vías
-  Acumulador
-  Tubo capilar
-  Sensor de baja presión
-  Sensor de alta presión
-  Compresor
-  Válvula solenoide
-  Distribuidor
-  Válvula de cierre
-  Termistor
-  Válvula de retención
-  Refrigeración
-  Calefacción