

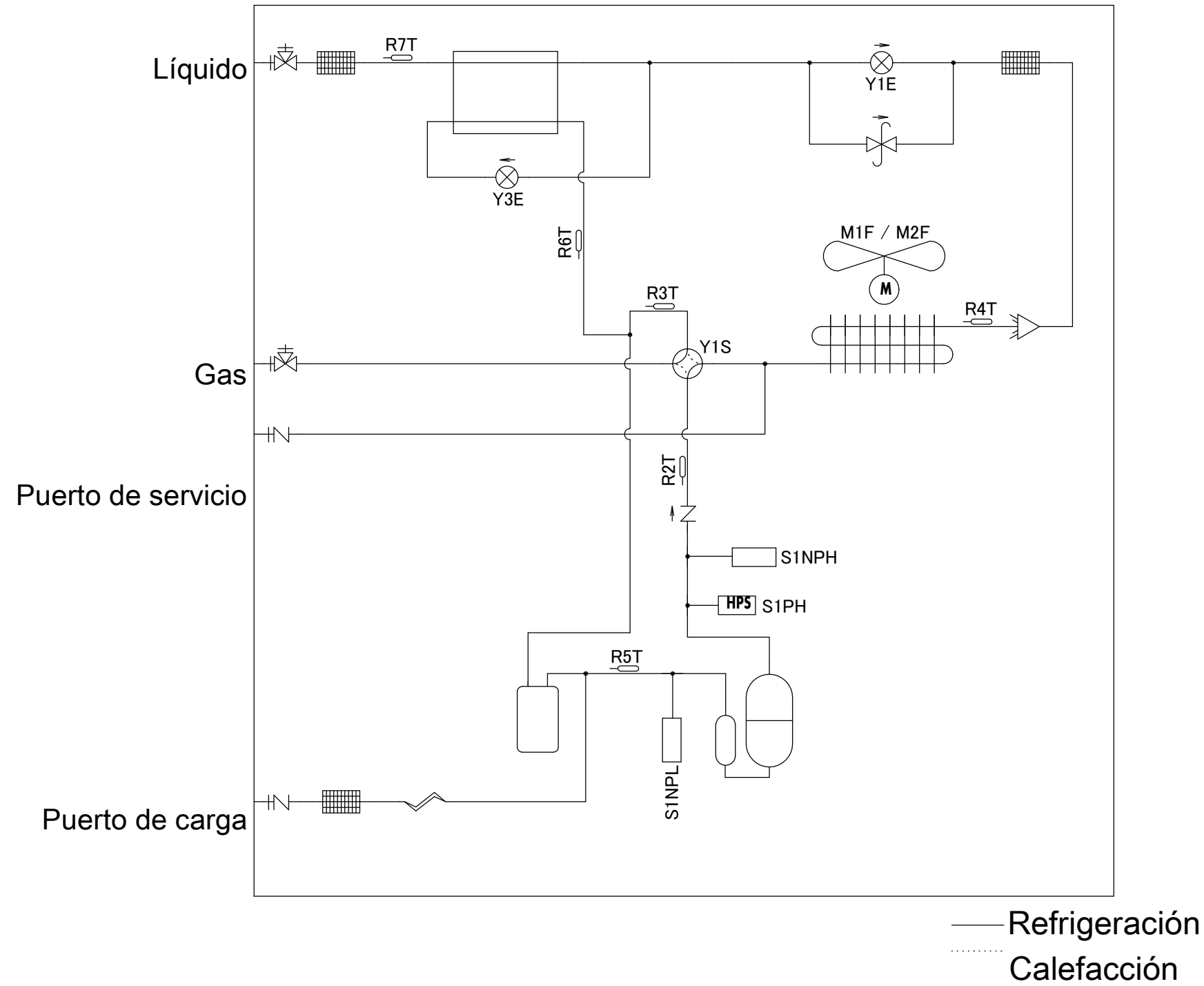



















RXYSQ-TV9



-  Puerto de carga / Puerto de servicio
-  Válvula de cierre
-  Filtro
-  Válvula de retención
-  Válvula de alivio de la presión
-  Termistor
-  Tubo capilar
-  Válvula de expansión
-  Válvula de 4 vías
-  Ventilador de hélices
-  Interruptor de alta presión
-  Sensor de alta presión
-  Acumulador
-  Intercambiador de calor
-  Compresor
-  Compresor
-  Acumulador
-  Intercambiador de calor de doble tubo
-  Distribuidor