

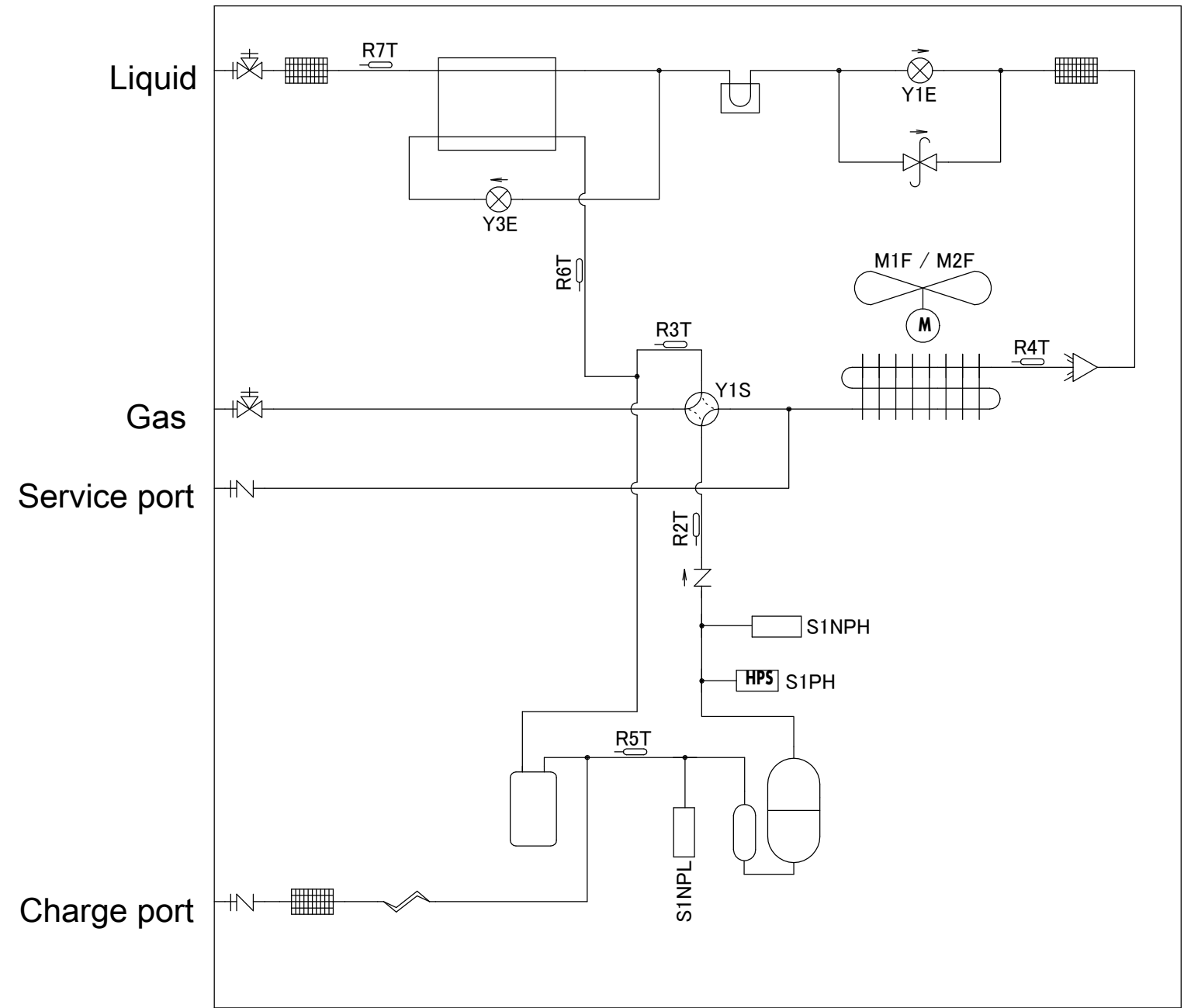



















RXYSQ-TV9



-  Charge port / Service port
-  Stop valve
-  Filter
-  Check valve
-  Pressure relief valve
-  Thermistor
-  Heat sink (PCB)
-  Capillary tube
-  Expansion valve
-  4-way valve
-  Propeller fan
-  High pressure switch
-  Low pressure sensor
-  High pressure sensor
-  Accumulator
-  Heat exchanger
-  Compressor
-  Compressor Accumulator
-  Double tube heat exchanger
-  Distributor