

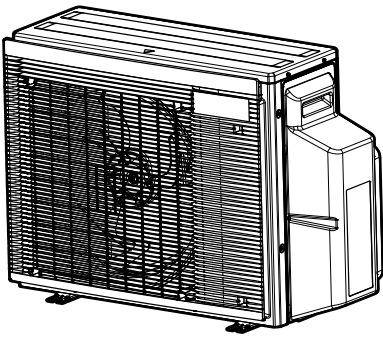

Installer reference guide
R32 Split series



5MWXM68A2V1B9
5MWXM90A2V1B9

Table of contents

1	About the documentation	4
1.1	About this document.....	4
1.1.1	Meaning of warnings and symbols.....	5
2	General safety precautions	7
2.1	For the installer	7
2.1.1	General.....	7
2.1.2	Installation site.....	8
2.1.3	Refrigerant — in case of R410A or R32.....	11
2.1.4	Electrical.....	12
3	Specific installer safety instructions	15
4	About the box	20
4.1	Outdoor unit.....	20
4.1.1	To unpack the outdoor unit.....	20
4.1.2	To handle the outdoor unit	20
4.1.3	To remove the accessories from the outdoor unit.....	21
5	About the unit	22
5.1	Identification	22
5.1.1	Identification label: Outdoor unit.....	22
6	Unit installation	23
6.1	Preparing the installation site.....	23
6.1.1	Installation site requirements of the outdoor unit.....	24
6.1.2	Additional installation site requirements of the outdoor unit in cold climates	26
6.2	Opening the unit	27
6.2.1	About opening the unit.....	27
6.2.2	To open the outdoor unit	27
6.3	Mounting the outdoor unit.....	27
6.3.1	About mounting the outdoor unit.....	27
6.3.2	Precautions when mounting the outdoor unit	28
6.3.3	To provide the installation structure.....	28
6.3.4	To install the outdoor unit.....	29
6.3.5	To provide drainage.....	29
6.3.6	To prevent the outdoor unit from falling over.....	30
7	Piping installation	31
7.1	Preparing refrigerant piping.....	31
7.1.1	Refrigerant piping requirements.....	31
7.1.2	Refrigerant piping insulation	32
7.1.3	Refrigerant piping length and height difference.....	33
7.2	Connecting the refrigerant piping.....	34
7.2.1	About connecting the refrigerant piping	34
7.2.2	Precautions when connecting the refrigerant piping	35
7.2.3	Guidelines when connecting the refrigerant piping	36
7.2.4	Pipe bending guidelines.....	37
7.2.5	To flare the pipe end	37
7.2.6	Connections between outdoor and indoor unit using reducers	37
7.2.7	Using the stop valve and service port	40
7.2.8	To connect the refrigerant piping to the outdoor unit.....	41
7.2.9	To install sound insulation.....	42
7.3	Checking the refrigerant piping	42
7.3.1	About checking the refrigerant piping	42
7.3.2	Precautions when checking the refrigerant piping.....	43
7.3.3	To check for leaks	43
7.3.4	To perform vacuum drying	44
8	Charging refrigerant	46
8.1	About charging refrigerant.....	46
8.2	About the refrigerant	47
8.3	Precautions when charging refrigerant	48
8.4	To determine the additional refrigerant amount.....	48
8.5	To determine the complete recharge amount.....	49
8.6	To charge additional refrigerant	49
8.7	To fix the fluorinated greenhouse gases label.....	49

8.8	To check refrigerant piping joints for leaks after charging refrigerant.....	50
9	Electrical installation	51
9.1	About connecting the electrical wiring.....	51
9.1.1	Precautions when connecting the electrical wiring.....	51
9.1.2	Guidelines when connecting the electrical wiring.....	53
9.1.3	Specifications of standard wiring components.....	54
9.2	To connect the electrical wiring to the outdoor unit.....	55
10	Finishing the outdoor unit installation	57
10.1	To finish the outdoor unit installation.....	57
10.2	To close the outdoor unit.....	57
11	Configuration	58
11.1	About standby electricity saving function.....	58
11.1.1	To turn ON standby electricity saving function.....	58
11.2	About priority room function.....	59
11.2.1	To set the priority room function.....	59
11.3	About night quiet mode.....	59
11.3.1	To turn ON the night quiet mode.....	59
11.4	About heat mode lock.....	60
11.4.1	To turn ON heat mode lock.....	60
12	Commissioning	61
12.1	Overview: Commissioning.....	61
12.2	Precautions when commissioning.....	61
12.3	Checklist before commissioning.....	62
12.4	Checklist during commissioning.....	62
12.5	Trial operation and testing.....	63
12.5.1	About wiring error check.....	63
12.5.2	To perform a test run.....	64
12.6	Starting up the outdoor unit.....	65
13	Hand-over to the user	66
14	Maintenance and service	67
14.1	Overview: Maintenance and service.....	67
14.2	Maintenance safety precautions.....	67
14.3	Checklist for yearly maintenance of the outdoor unit.....	68
14.4	About the compressor.....	68
15	Troubleshooting	69
15.1	Overview: Troubleshooting.....	69
15.2	Precautions when troubleshooting.....	69
15.3	Solving problems based on symptoms.....	69
15.3.1	Symptom: Indoor units fall, vibrate or make noise.....	69
15.3.2	Symptom: The unit is NOT heating or cooling as expected.....	69
15.3.3	Symptom: Water leakage.....	70
15.3.4	Symptom: Electrical leakage.....	70
15.3.5	Symptom: Priority room setting does NOT function.....	70
15.3.6	Symptom: Unit does NOT function or burn damage.....	70
15.4	Solving problems based on LED behaviour.....	70
15.4.1	Fault diagnosis using LED on outdoor unit PCB.....	70
16	Disposal	72
16.1	Overview: Disposal.....	72
16.2	To pump down.....	72
16.3	To start and stop forced cooling.....	73
17	Technical data	75
17.1	Wiring diagram.....	75
17.1.1	Unified wiring diagram legend.....	75
17.2	Piping diagram: Outdoor unit.....	77
18	Glossary	80

1 About the documentation

1.1 About this document



WARNING

Make sure installation, servicing, maintenance, repair and applied materials follow the instructions from Daikin (including all documents listed in “Documentation set”) and, in addition, comply with applicable legislation and are performed by qualified persons only. In Europe and areas where IEC standards apply, EN/IEC 60335-2-40 is the applicable standard.

Target audience

Authorised installers



INFORMATION

This appliance is intended to be used by expert or trained users in shops, in light industry, and on farms, or for commercial and household use by lay persons.



INFORMATION

This document only describes installation instructions specific to the outdoor unit. For installation of the indoor unit (mounting the indoor unit, connecting the refrigerant piping to the indoor unit, connecting the electrical wiring to the indoor unit ...), see the installation manual of the indoor unit.

Documentation set

This document is part of a documentation set. The complete set consists of:

- **General safety precautions:**
 - Safety instructions that you **MUST** read before installing
 - Format: Paper (in the box of the outdoor unit)
- **Outdoor unit installation manual:**
 - Installation instructions
 - Format: Paper (in the box of the outdoor unit)
- **Installer reference guide:**
 - Preparation of the installation, reference data, ...
 - Format: Digital files on <https://www.daikin.eu>. Use the search function 🔍 to find your model.

The latest revision of the supplied documentation is published on the regional Daikin website and is available via your dealer.

Scan the QR code below to find the full documentation set and more information about your product on the Daikin website.

5MXXM-A9











The original instructions are written in English. All other languages are translations of the original instructions.



Technical engineering data



- A **subset** of the latest technical data is available on the regional Daikin website (publicly accessible).
- The **full set** of the latest technical data is available on the Daikin Business Portal (authentication required).

1.1.1 Meaning of warnings and symbols



	DANGER Indicates a situation that results in death or serious injury.
	DANGER: RISK OF ELECTROCUTION Indicates a situation that could result in electrocution.
	DANGER: RISK OF BURNING/SCALDING Indicates a situation that could result in burning/scalding because of extreme hot or cold temperatures.
	DANGER: RISK OF EXPLOSION Indicates a situation that could result in explosion.
	WARNING Indicates a situation that could result in death or serious injury.
	WARNING: FLAMMABLE MATERIAL
 A2L	WARNING: MILDLY FLAMMABLE MATERIAL The refrigerant inside this unit is mildly flammable.
	CAUTION Indicates a situation that could result in minor or moderate injury.
	NOTICE Indicates a situation that could result in equipment or property damage.
	INFORMATION Indicates useful tips or additional information.

Symbols used on the unit:

Symbol	Explanation
	Before installation, read the installation and operation manual, and the wiring instruction sheet.
	Before performing maintenance and service tasks, read the service manual.

Symbol	Explanation
	For more information, see the installer and user reference guide.
	The unit contains rotating parts. Be careful when servicing or inspecting the unit.

Symbols used in the documentation:

Symbol	Explanation
	Indicates a figure title or a reference to it. Example: "1-3 Figure title" means "Figure 3 in chapter 1".
	Indicates a table title or a reference to it. Example: "1-3 Table title" means "Table 3 in chapter 1".

2 General safety precautions

2.1 For the installer

2.1.1 General

If you are NOT sure how to install or operate the unit, contact your dealer.



DANGER: RISK OF BURNING/SCALDING

- Do NOT touch the refrigerant piping, water piping or internal parts during and immediately after operation. It could be too hot or too cold. Give it time to return to normal temperature. If you MUST touch it, wear protective gloves.
- Do NOT touch any accidental leaking refrigerant.



WARNING

Improper installation or attachment of equipment or accessories could result in electrical shock, short-circuit, leaks, fire or other damage to the equipment. ONLY use accessories, optional equipment and spare parts made or approved by Daikin unless otherwise specified.



WARNING

Make sure installation, testing and applied materials comply with applicable legislation (on top of the instructions described in the Daikin documentation).



WARNING

Tear apart and throw away plastic packaging bags so that nobody, especially children, can play with them. **Possible consequence:** suffocation.



WARNING

Provide adequate measures to prevent that the unit can be used as a shelter by small animals. Small animals that make contact with electrical parts can cause malfunctions, smoke or fire.



CAUTION

Wear adequate personal protective equipment (protective gloves, safety glasses,...) when installing, maintaining or servicing the system.



CAUTION

Do NOT touch the air inlet or aluminium fins of the unit.



CAUTION

- Do NOT place any objects or equipment on top of the unit.
- Do NOT sit, climb or stand on the unit.

In accordance with the applicable legislation, it might be necessary to provide a logbook with the product containing at least: information on maintenance, repair work, results of tests, stand-by periods,...

Also, at least, following information MUST be provided at an accessible place at the product:

- Instructions for shutting down the system in case of an emergency

- Name and address of fire department, police and hospital
- Name, address and day and night telephone numbers for obtaining service

In Europe, EN378 provides the necessary guidance for this logbook.

2.1.2 Installation site

- Provide sufficient space around the unit for servicing and air circulation.
- Make sure the installation site withstands the weight and vibration of the unit.
- Make sure the area is well ventilated. Do NOT block any ventilation openings.
- Make sure the unit is level.

Do NOT install the unit in the following places:

- In potentially explosive atmospheres.
- In places where there is machinery that emits electromagnetic waves. Electromagnetic waves may disturb the control system, and cause malfunction of the equipment.
- In places where there is a risk of fire due to the leakage of flammable gases (example: thinner or gasoline), carbon fibre, ignitable dust.
- In places where corrosive gas (example: sulphurous acid gas) is produced. Corrosion of copper pipes or soldered parts may cause the refrigerant to leak.

Instructions for equipment using R32 refrigerant



A2L

WARNING: MILDLY FLAMMABLE MATERIAL

The refrigerant inside this unit is mildly flammable.



WARNING

- Do NOT pierce or burn refrigerant cycle parts.
- Do NOT use cleaning materials or means to accelerate the defrosting process other than those recommended by the manufacturer.
- Be aware that the refrigerant inside the system is odourless.



WARNING

The appliance shall be stored so as to prevent mechanical damage and in a well-ventilated room without continuously operating ignition sources (example: open flames, an operating gas appliance or an operating electric heater) and have a room size as specified below.



WARNING

Make sure installation, servicing, maintenance and repair comply with instructions from Daikin and with applicable legislation (for example national gas regulation) and are executed ONLY by authorised persons.

**WARNING**

- Take precautions to avoid excessive vibration or pulsation to refrigeration piping.
- Protect the protection devices, piping and fittings as much as possible against adverse environmental effects.
- Provide space for expansion and contraction of long runs of piping.
- Design and install piping in refrigerating systems such as to minimise the likelihood of hydraulic shock damaging the system.
- Mount the indoor equipment and pipes securely and protect them to avoid accidental rupture of equipment or pipes in case of events such as moving furniture or reconstruction activities.

**WARNING**

If one or more rooms are connected to the unit using a duct system, make sure:

- there are no operating ignition sources (example: open flames, an operating gas appliance or an operating electric heater) in case the floor area is less than the minimum floor area A (m²).
- no auxiliary devices, which may be a potential ignition source, are installed in the duct work (example: hot surfaces with a temperature exceeding 700°C and electric switching device);
- only auxiliary devices approved by the manufacturer are used in the duct work;
- air inlet AND outlet are connected directly to the same room by ducting. Do NOT use spaces such as a false ceiling as a duct for the air inlet or outlet.

**CAUTION**

Do NOT use potential sources of ignition in searching for or detection of refrigerant leaks.

**NOTICE**

- Do NOT re-use joints and copper gaskets which have been used already.
- Joints made in the installation between parts of the refrigerant system shall be accessible for maintenance purposes.

Installation space requirements**WARNING**

If appliances contain R32 refrigerant, the floor area of the room in which the appliances are installed, operated and stored **MUST** be larger than the minimum floor area defined in table below A (m²). This applies to:

- Indoor units **without** a refrigerant leakage sensor; in case of indoor units **with** refrigerant leakage sensor, consult the installation manual
- Outdoor units installed or stored indoors (e.g. winter garden, garage, machinery room)

**NOTICE**

- The pipework shall be securely mounted and guarded protected from physical damage.
- Keep the pipework installation to a minimum.

To determine the minimum floor area

- 1 Determine the total refrigerant charge in the system (= factory refrigerant charge ① + ② additional refrigerant amount charged).

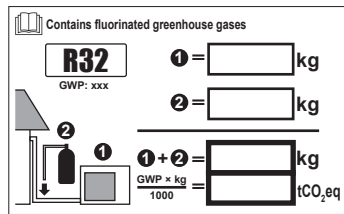

2 Determine which graph or table to use.

- For indoor units: Is the unit ceiling-mounted, wall-mounted or floor-standing?
- For outdoor units installed or stored indoors, this depends on the installation height:

If the installation height is...	Then use the graph or table for...
<1.8 m	Floor-standing units
1.8 ≤ x < 2.2 m	Wall-mounted units
≥ 2.2 m	Ceiling-mounted units

3 Use the graph or table to determine the minimum floor area.

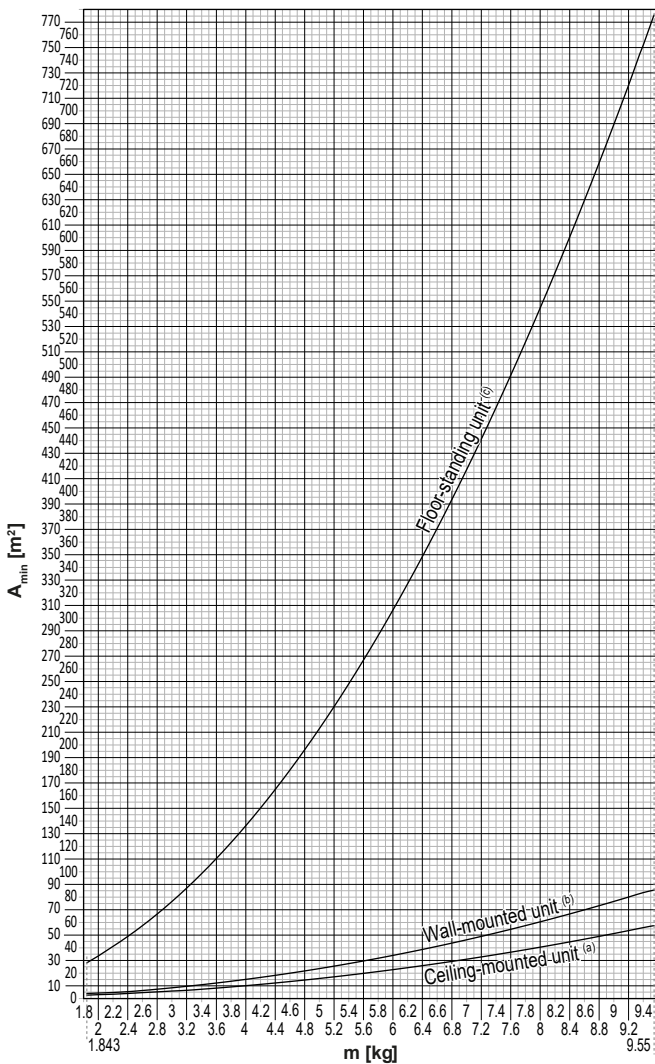

Ceiling-mounted unit ^(a)		Wall-mounted unit ^(b)		Floor-standing unit ^(c)	
m (kg)	A _{min} (m ²)	m (kg)	A _{min} (m ²)	m (kg)	A _{min} (m ²)
≤1.842	—	≤1.842	—	≤1.842	—
1.843	3.64	1.843	4.45	1.843	28.9
2.0	3.95	2.0	4.83	2.0	34.0
2.2	4.34	2.2	5.31	2.2	41.2
2.4	4.74	2.4	5.79	2.4	49.0
2.6	5.13	2.6	6.39	2.6	57.5
2.8	5.53	2.8	7.41	2.8	66.7
3.0	5.92	3.0	8.51	3.0	76.6
3.2	6.48	3.2	9.68	3.2	87.2
3.4	7.32	3.4	10.9	3.4	98.4
3.6	8.20	3.6	12.3	3.6	110
3.8	9.14	3.8	13.7	3.8	123
4.0	10.1	4.0	15.1	4.0	136
4.2	11.2	4.2	16.7	4.2	150
4.4	12.3	4.4	18.3	4.4	165
4.6	13.4	4.6	20.0	4.6	180
4.8	14.6	4.8	21.8	4.8	196
5.0	15.8	5.0	23.6	5.0	213
5.2	17.1	5.2	25.6	5.2	230
5.4	18.5	5.4	27.6	5.4	248
5.6	19.9	5.6	29.7	5.6	267
5.8	21.3	5.8	31.8	5.8	286
6.0	22.8	6.0	34.0	6.0	306
6.2	24.3	6.2	36.4	6.2	327
6.4	25.9	6.4	38.7	6.4	349
6.6	27.6	6.6	41.2	6.6	371
6.8	29.3	6.8	43.7	6.8	394
7.0	31.0	7.0	46.3	7.0	417
7.2	32.8	7.2	49.0	7.2	441
7.4	34.7	7.4	51.8	7.4	466
7.6	36.6	7.6	54.6	7.6	492
7.8	38.5	7.8	57.5	7.8	518
8	40.5	8	60.5	8	545
8.2	42.6	8.2	63.6	8.2	572
8.4	44.7	8.4	66.7	8.4	601
8.6	46.8	8.6	69.9	8.6	629
8.8	49.0	8.8	73.2	8.8	659
9	51.3	9	76.6	9	689
9.2	53.6	9.2	80.0	9.2	720
9.4	55.9	9.4	83.6	9.4	752
9.55	57.7	9.55	86.2	9.55	776

- m** Total refrigerant charge in the system
- A_{min}** Minimum floor area
- (a)** Ceiling-mounted unit (= Ceiling-mounted unit)
- (b)** Wall-mounted unit (= Wall-mounted unit)
- (c)** Floor-standing unit (= Floor-standing unit)

2.1.3 Refrigerant — in case of R410A or R32

If applicable. See the installation manual or installer reference guide of your application for more information.

**DANGER: RISK OF EXPLOSION**

Pump down – Refrigerant leakage. If you want to pump down the system, and there is a leak in the refrigerant circuit:

- Do NOT use the unit's automatic pump down function, with which you can collect all refrigerant from the system into the outdoor unit. **Possible consequence:** Self-combustion and explosion of the compressor because of air going into the operating compressor.
- Use a separate recovery system so that the unit's compressor does NOT have to operate.

**WARNING**

During tests, NEVER pressurise the product with a pressure higher than the maximum allowable pressure (as indicated on the nameplate of the unit).

**WARNING**

Take sufficient precautions in case of refrigerant leakage. If refrigerant gas leaks, ventilate the area immediately. Possible risks:

- Excessive refrigerant concentrations in a closed room can lead to oxygen deficiency.
- Toxic gas might be produced if refrigerant gas comes into contact with fire.

**WARNING**

ALWAYS recover the refrigerant. Do NOT release them directly into the environment. Use a vacuum pump to evacuate the installation.

**WARNING**

Make sure there is no oxygen in the system. Refrigerant may ONLY be charged after performing the leak test and the vacuum drying.

Possible consequence: Self-combustion and explosion of the compressor because of oxygen going into the operating compressor.

**NOTICE**

- To avoid compressor breakdown, do NOT charge more than the specified amount of refrigerant.
- When the refrigerant system is to be opened, refrigerant MUST be treated according to the applicable legislation.

**NOTICE**

Make sure refrigerant piping installation complies with applicable legislation. In Europe, EN378 is the applicable standard.



**NOTICE**

Make sure the field piping and connections are NOT subjected to stress.

**NOTICE**

After all the piping has been connected, make sure there is no gas leak. Use nitrogen to perform a gas leak detection.

- In case recharge is required, see the nameplate or the refrigerant charge label of the unit. It states the type of refrigerant and necessary amount.
- Whether the unit is factory charged with refrigerant or non-charged, in both cases you might need to charge additional refrigerant, depending on the pipe sizes and pipe lengths of the system.
- **ONLY** use tools exclusively for the refrigerant type used in the system, this to ensure pressure resistance and prevent foreign materials from entering into the system.
- Charge the liquid refrigerant as follows:

If	Then
A siphon tube is present (i.e., the cylinder is marked with "Liquid filling siphon attached")	Charge with the cylinder upright. 
A siphon tube is NOT present	Charge with the cylinder upside down. 

- Open refrigerant cylinders slowly.
- Charge the refrigerant in liquid form. Adding it in gas form may prevent normal operation.



CAUTION

When the refrigerant charging procedure is done or when pausing, close the valve of the refrigerant tank immediately. If the valve is **NOT** closed immediately, remaining pressure might charge additional refrigerant. **Possible consequence:** Incorrect refrigerant amount.

2.1.4 Electrical



DANGER: RISK OF ELECTROCUTION

- Turn OFF all power supply before removing the switch box cover, connecting electrical wiring or touching electrical parts.
- Disconnect the power supply for more than 10 minutes, and measure the voltage at the terminals of main circuit capacitors or electrical components before servicing. The voltage **MUST** be less than 50 V DC before you can touch electrical components. For the location of the terminals, see the wiring diagram.
- Do **NOT** touch electrical components with wet hands.
- Do **NOT** leave the unit unattended when the service cover is removed.



WARNING

If **NOT** factory installed, a main switch or other means for disconnection, having a contact separation in all poles providing full disconnection under overvoltage category III condition, **MUST** be installed in the fixed wiring.

**WARNING**

- ONLY use copper wires.
- Make sure the field wiring complies with the national wiring regulations.
- All field wiring **MUST** be performed in accordance with the wiring diagram supplied with the product.
- NEVER squeeze bundled cables and make sure they do NOT come in contact with the piping and sharp edges. Make sure no external pressure is applied to the terminal connections.
- Make sure to install earth wiring. Do NOT earth the unit to a utility pipe, surge absorber, or telephone earth. Incomplete earth may cause electrical shock.
- Make sure to use a dedicated power circuit. NEVER use a power supply shared by another appliance.
- Make sure to install the required fuses or circuit breakers.
- Make sure to install an earth leakage protector. Failure to do so may cause electrical shock or fire.
- When installing the earth leakage protector, make sure it is compatible with the inverter (resistant to high frequency electric noise) to avoid unnecessary opening of the earth leakage protector.

**WARNING**

- After finishing the electrical work, confirm that each electrical component and terminal inside the switch box is connected securely.
- Make sure all covers are closed before starting up the unit.

**CAUTION**

- When connecting the power supply: connect the earth cable first, before making the current-carrying connections.
- When disconnecting the power supply: disconnect the current-carrying cables first, before separating the earth connection.
- The length of the conductors between the power supply stress relief and the terminal block itself **MUST** be as such that the current-carrying wires are tautened before the earth wire is in case the power supply is pulled loose from the stress relief.

**NOTICE**

Precautions when laying power wiring:



- Do NOT connect wiring of different thicknesses to the power terminal block (slack in the power wiring may cause abnormal heat).
- When connecting wiring which is the same thickness, do as shown in the figure above.
- For wiring, use the designated power wire and connect firmly, then secure to prevent outside pressure being exerted on the terminal board.
- Use an appropriate screwdriver for tightening the terminal screws. A screwdriver with a small head will damage the head and make proper tightening impossible.
- Over-tightening the terminal screws may break them.

Install power cables at least 1 meter away from televisions or radios to prevent interference. Depending on the radio waves, a distance of 1 meter may NOT be sufficient.

**NOTICE**

ONLY applicable if the power supply is three-phase, and the compressor has an ON/OFF starting method.

If there exists the possibility of reversed phase after a momentary black out and the power goes ON and OFF while the product is operating, attach a reversed phase protection circuit locally. Running the product in reversed phase can break the compressor and other parts.

3 Specific installer safety instructions

Always observe the following safety instructions and regulations.

To handle the outdoor unit (see "4.1.2 To handle the outdoor unit" [▶ 20])



CAUTION

To avoid injury, do NOT touch the air inlet or aluminium fins of the unit.



CAUTION

ONLY handle the outdoor unit as follows:

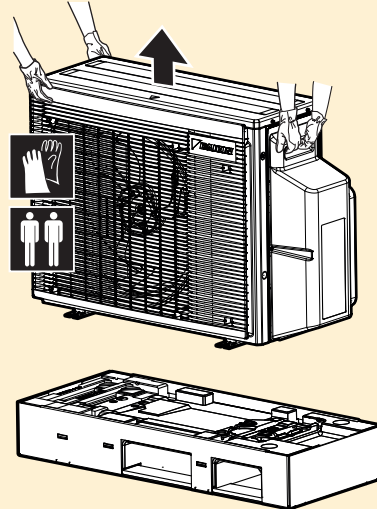

Unit installation (see "6 Unit installation" [▶ 23])



WARNING

Installation shall be done by an installer, the choice of materials and installation shall comply with the applicable legislation. In Europe, EN378 is the applicable standard.

Installation site (see "6.1 Preparing the installation site" [▶ 23])



CAUTION

- Check if the installation location can support the unit's weight. Poor installation is hazardous. It can also cause vibrations or unusual operating noise.
- Provide sufficient service space.
- Do NOT install the unit so that it is in contact with a ceiling or a wall, as this may cause vibrations.



WARNING

The appliance shall be stored so as to prevent mechanical damage and in a well-ventilated room without continuously operating ignition sources (e.g. open flames, an operating gas appliance, or an operating electric heater). The room size shall be as specified in the General safety precaution.

Opening the unit (see "6.2 Opening the unit" [▶ 27])



DANGER: RISK OF ELECTROCUTION

Do NOT leave the unit unattended when the service cover is removed.



DANGER: RISK OF BURNING/SCALDING



DANGER: RISK OF ELECTROCUTION

Piping installation (see "7 Piping installation" [▶ 31])



CAUTION

Piping and joints of a split system shall be made with permanent joints when inside an occupied space except joints directly connecting the piping to the indoor units.



CAUTION

- No brazing or welding on site for units with R32 refrigerant charge during shipment.
- During installation of the refrigeration system, joining of parts with at least one part charged shall be performed taking into account the following requirements: inside occupied spaces non-permanent joints are NOT allowed for R32 refrigerant except for site made joints directly connecting the indoor unit to piping. Site made joints directly connecting piping to indoor units shall be of non-permanent type.



CAUTION

Do NOT connect the embedded branch piping and the outdoor unit when only carrying out piping work without connecting the indoor unit in order to add another indoor unit later.



WARNING

Connect the refrigerant piping securely before running the compressor. If the refrigerant piping is NOT connected and the stop valve is open when the compressor is run, air will be sucked in. This will cause abnormal pressure in the refrigeration cycle, which may result in equipment damage and even injury.



CAUTION

- Incomplete flaring may cause refrigerant gas leakage.
- Do NOT re-use flares. Use new flares to prevent refrigerant gas leakage.
- Use flare nuts that are included with the unit. Using different flare nuts may cause refrigerant gas leakage.



CAUTION

Do NOT open the valves before flaring is complete. This would cause refrigerant gas leakage.



DANGER: RISK OF EXPLOSION

Do NOT open the stop valves before the vacuum drying is finished.

Charging refrigerant (see "8 Charging refrigerant" [▶ 46])



A2L

WARNING: MILDLY FLAMMABLE MATERIAL

The refrigerant inside this unit is mildly flammable.

**WARNING**

- The refrigerant inside the unit is mildly flammable, but normally does NOT leak. If the refrigerant leaks in the room and comes in contact with fire from a burner, a heater, or a cooker, this may result in fire, or the formation of a harmful gas.
- Turn OFF any combustible heating devices, ventilate the room, and contact the dealer where you purchased the unit.
- Do NOT use the unit until a service person confirms that the part from which the refrigerant leaked has been repaired.

**WARNING**

- Only use R32 as refrigerant. Other substances may cause explosions and accidents.
- R32 contains fluorinated greenhouse gases. Its global warming potential (GWP) value is 675. Do NOT vent these gases into the atmosphere.
- When charging refrigerant, ALWAYS use protective gloves and safety glasses.

**WARNING**

NEVER directly touch any accidental leaking refrigerant. This could result in severe wounds caused by frostbite.

Electrical installation (see "9 Electrical installation" [▶ 51])**WARNING**

- All wiring MUST be performed by an authorised electrician and MUST comply with the national wiring regulation.
- Make electrical connections to the fixed wiring.
- All components procured on-site and all electrical construction MUST comply with the applicable legislation.

**WARNING**

- If the power supply has a missing or wrong N-phase, equipment might break down.
- Establish proper earthing. Do NOT earth the unit to a utility pipe, surge absorber, or telephone earth. Incomplete earthing may cause electrical shocks.
- Install the required fuses or circuit breakers.
- Secure the electrical wiring with cable ties so that the cables do NOT come in contact with sharp edges or piping, particularly on the high-pressure side.
- Do NOT use taped wires, extension cords, or connections from a star system. They can cause overheating, electrical shocks or fire.
- Do NOT install a phase advancing capacitor, because this unit is equipped with an inverter. A phase advancing capacitor will reduce performance and may cause accidents.

**WARNING**

ALWAYS use multicore cable for power supply cables.

**WARNING**

Use an all-pole disconnection type breaker with at least 3 mm between the contact point gaps that provides full disconnection under overvoltage category III.

**WARNING**

If the supply cord is damaged, it **MUST** be replaced by the manufacturer, its service agent or similarly qualified persons in order to avoid a hazard.

**WARNING**

Do **NOT** connect the power supply to the indoor unit. This could result in electrical shock or fire.

**WARNING**

- Do **NOT** use locally purchased electrical parts inside the product.
- Do **NOT** branch the power supply for the drain pump, etc. from the terminal block. This could result in electrical shock or fire.

**WARNING**

Keep the interconnection wiring away from copper pipes without thermal insulation as such pipes will be very hot.

**DANGER: RISK OF ELECTROCUTION**

All electrical parts (including thermistors) are powered by the power supply. Do **NOT** touch them with bare hands.

**DANGER: RISK OF ELECTROCUTION**

Disconnect the power supply for more than 10 minutes, and measure the voltage at the terminals of main circuit capacitors or electrical components before servicing. The voltage **MUST** be less than 50 V DC before you can touch electrical components. For the location of the terminals, see the wiring diagram.

Finishing the outdoor unit installation (see "10 Finishing the outdoor unit installation" [▶ 57])

**DANGER: RISK OF ELECTROCUTION**

- Make sure that the system is earthed properly.
- Turn **OFF** the power supply before servicing.
- Install the switch box cover before turning **ON** the power supply.

Maintenance and service (see "14 Maintenance and service" [▶ 67])

**DANGER: RISK OF ELECTROCUTION****DANGER: RISK OF BURNING/SCALDING**

**WARNING**

- Before carrying out any maintenance or repair activity, ALWAYS switch off the circuit breaker on the supply panel, remove the fuses or open the protection devices of the unit.
- Do NOT touch live parts for 10 minutes after the power supply is turned off because of high voltage risk.
- Please note that some sections of the electric component box are hot.
- Make sure you do NOT touch a conductive section.
- Do NOT rinse the unit. This may cause electric shocks or fire.

**DANGER: RISK OF ELECTROCUTION**

- Use this compressor on a grounded system only.
- Turn the power off before servicing the compressor.
- Reattach the switch box cover and service lid after servicing.

**CAUTION**

ALWAYS wear safety glasses and protective gloves.

**DANGER: RISK OF EXPLOSION**

- Use a pipe cutter to remove the compressor.
- Do NOT use the brazing torch.
- Use approved refrigerants and lubricants only.

**DANGER: RISK OF BURNING/SCALDING**

Do NOT touch the compressor with bare hands.

Troubleshooting (see "15 Troubleshooting" [▶ 69])

**WARNING**

- When carrying out an inspection on the switch box of the unit, ALWAYS make sure that the unit is disconnected from the mains. Turn off the respective circuit breaker.
- When a safety device was activated, stop the unit and find out why the safety device was activated before resetting it. NEVER shunt safety devices or change their values to a value other than the factory default setting. If you are unable to find the cause of the problem, call your dealer.

**WARNING**

Prevent hazards due to inadvertent resetting of the thermal cut-out: power to this appliance MUST NOT be supplied through an external switching device, such as a timer, or connected to a circuit that is regularly turned ON and OFF by the utility.

**DANGER: RISK OF ELECTROCUTION**

- When the unit is NOT operating, the LEDs on the PCB are turned OFF in order to save power.
- Even when the LEDs are OFF, the terminal block and the PCB may be powered.

4 About the box

Keep the following in mind:

- At delivery, the unit **MUST** be checked for damage and completeness. Any damage or missing parts **MUST** be reported immediately to the claims agent of the carrier.
- Bring the packed unit as close as possible to its final installation position to prevent damage during transport.
- Prepare in advance the path along which you want to bring the unit to its final installation position.
- When handling the unit, take into account the following:



Fragile, handle the unit with care.



Keep the unit upright in order to avoid damage.

4.1 Outdoor unit

4.1.1 To unpack the outdoor unit

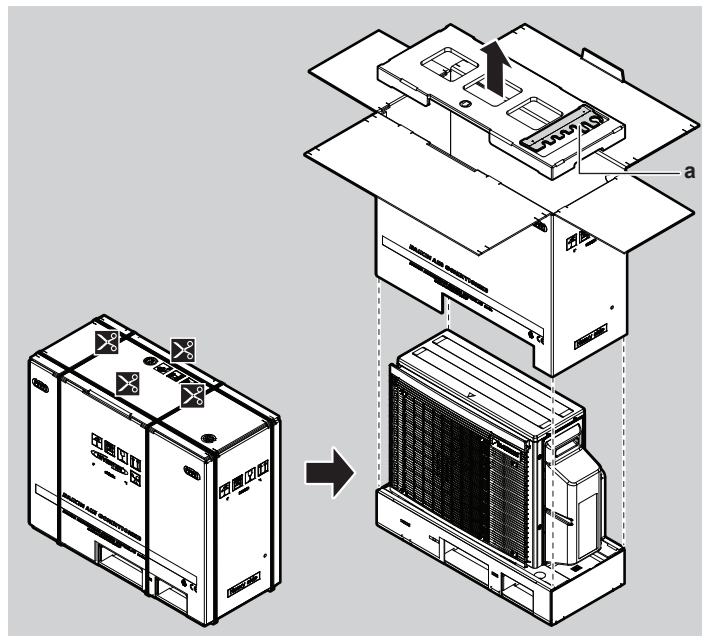

a Sound insulation part

4.1.2 To handle the outdoor unit



CAUTION

To avoid injury, do NOT touch the air inlet or aluminium fins of the unit.

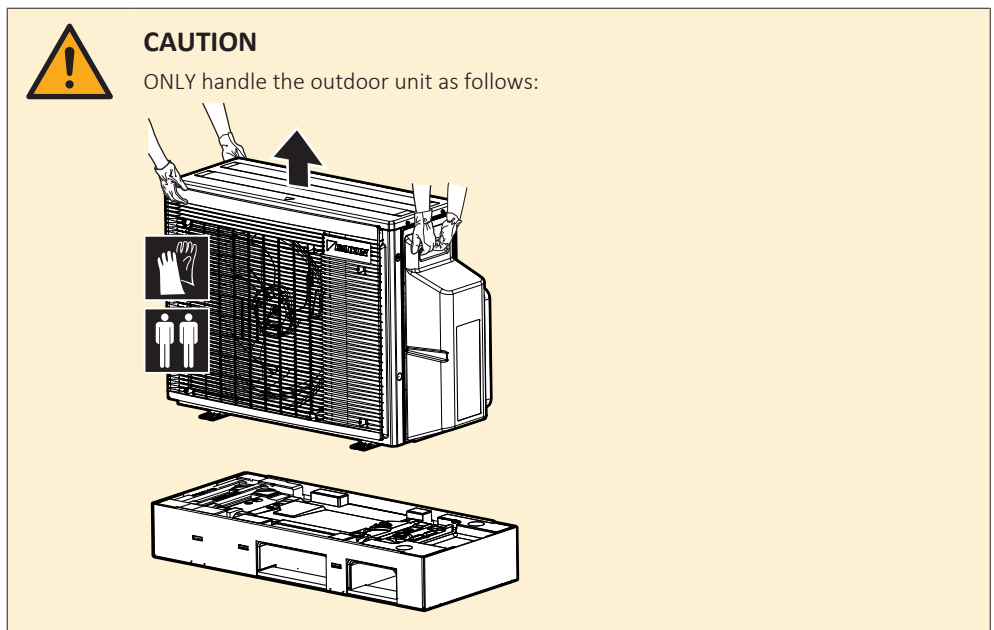
**NOTICE**

- Place the unit on a flat surface.
- Make sure the aluminium fins on the unit are straight before installation. If not, straighten them with a fin comb (field supply).

4.1.3 To remove the accessories from the outdoor unit

- 1 Lift the outdoor unit.
- 2 Remove the accessories from the bottom of the package.
- 3 Make sure you have all following accessories delivered with the unit:

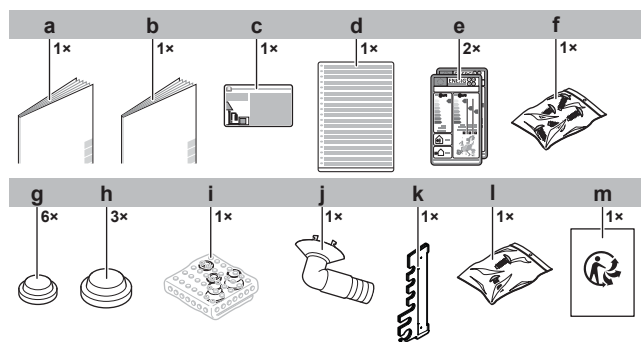

- a Outdoor unit installation manual
- b General safety precautions
- c Fluorinated greenhouse gases label
- d Multilingual fluorinated greenhouse gases label
- e Energy label
- f Screw bag. The screws will be used for fixing the electrical wire anchor bands.
- g Drain cap (small)
- h Drain cap (large)
- i Reducer assembly
- j Drain socket
- k Sound insulation plate
- l Screw bag. The screws will be used for fixing the sound insulation plate.
- m Triman logo addendum (for France)

5 About the unit



INFORMATION

For all possible combination of the outdoor unit with the air-conditioning indoor unit or the DHW tank, see the combination table. For details, contact your dealer.



A2L

WARNING: MILDLY FLAMMABLE MATERIAL

The refrigerant inside this unit is mildly flammable.



INFORMATION

For the operation limits see the latest technical data of the outdoor unit on the regional Daikin website (publicly accessible).

5.1 Identification

5.1.1 Identification label: Outdoor unit

Location

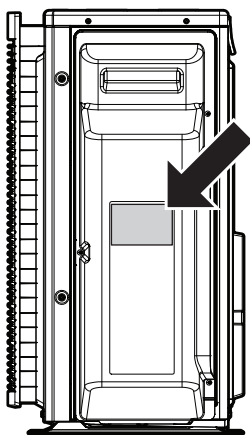

6 Unit installation



WARNING

Installation shall be done by an installer, the choice of materials and installation shall comply with the applicable legislation. In Europe, EN378 is the applicable standard.

In this chapter

6.1	Preparing the installation site	23
6.1.1	Installation site requirements of the outdoor unit	24
6.1.2	Additional installation site requirements of the outdoor unit in cold climates	26
6.2	Opening the unit.....	27
6.2.1	About opening the unit.....	27
6.2.2	To open the outdoor unit	27
6.3	Mounting the outdoor unit	27
6.3.1	About mounting the outdoor unit.....	27
6.3.2	Precautions when mounting the outdoor unit.....	28
6.3.3	To provide the installation structure.....	28
6.3.4	To install the outdoor unit	29
6.3.5	To provide drainage	29
6.3.6	To prevent the outdoor unit from falling over	30

6.1 Preparing the installation site



WARNING

The appliance shall be stored so as to prevent mechanical damage and in a well-ventilated room without continuously operating ignition sources (e.g. open flames, an operating gas appliance, or an operating electric heater). The room size shall be as specified in the General safety precaution.

Choose an installation location with sufficient space to transport the unit in and out of the site.

Do NOT install the unit in places often used as work place. In case of construction works (e.g. grinding works) where a lot of dust is created, the unit MUST be covered.



CAUTION

- Check if the installation location can support the unit's weight. Poor installation is hazardous. It can also cause vibrations or unusual operating noise.
- Provide sufficient service space.
- Do NOT install the unit so that it is in contact with a ceiling or a wall, as this may cause vibrations.

- Choose a location where the operation noise or the hot/cold air discharged from the unit will not disturb anyone and the location is selected according to the applicable legislation.
- Provide sufficient space around the unit for servicing and air circulation.
- Avoid areas where flammable gas or product might leak.
- Install units, power cables and communication wiring at least 3 m away from televisions or radios to prevent interference. Depending on the radio waves, a distance of 3 m may not be sufficient.



NOTICE

Do NOT place objects below the indoor and/or outdoor unit that may get wet. Otherwise condensation on the unit or refrigerant pipes, air filter dirt or drain blockage may cause dripping, and objects under the unit may get dirty or damaged.

6.1.1 Installation site requirements of the outdoor unit



INFORMATION

Also read the following requirements:

- "2 General safety precautions" [▶ 7].
- "7.1.3 Refrigerant piping length and height difference" [▶ 33].

Mind the following spacing guidelines:

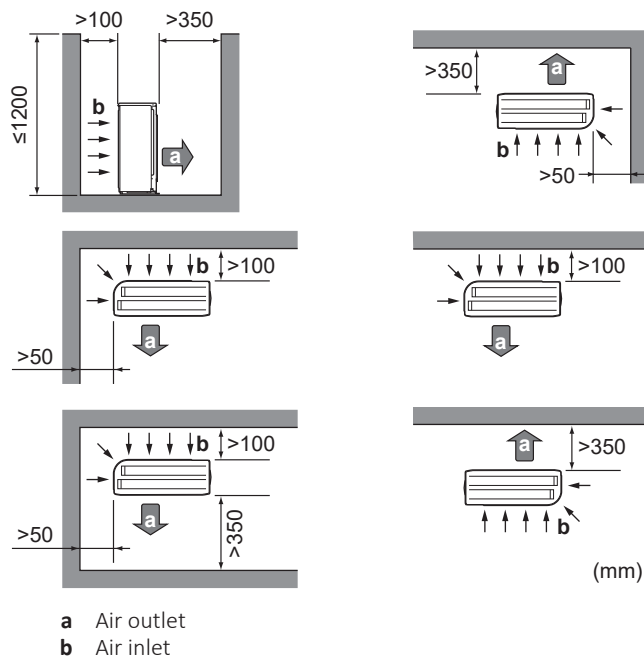

Allow 300 mm of work space below the ceiling surface and 250 mm for piping and electrical servicing.

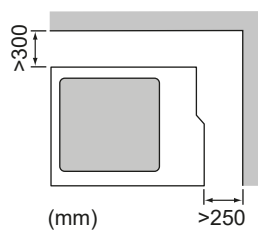

NOTICE

- Do NOT stack the units on each other.
- Do NOT hang the unit on a ceiling.

Strong winds (≥ 18 km/h) blowing against the outdoor unit's air outlet causes short circuit (suction of discharge air). This may result in:

- deterioration of the operational capacity;
- frequent frost acceleration in heating operation;
- disruption of operation due to decrease of low pressure or increase of high pressure;

- a broken fan (if a strong wind blows continuously on the fan, it may start rotating very fast, until it breaks).

It is recommended to install a baffle plate when the air outlet is exposed to wind.

It is recommended to install the outdoor unit with the air inlet facing the wall and NOT directly exposed to the wind.

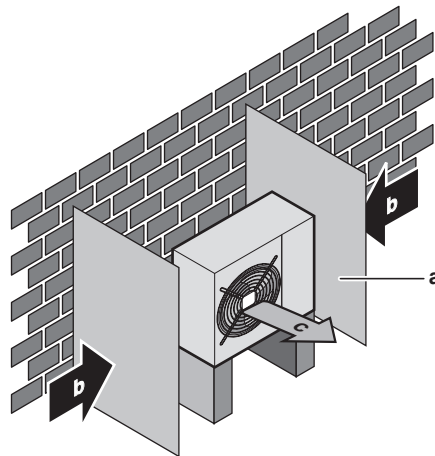

- a Baffle plate
- b Prevailing wind direction
- c Air outlet

Do NOT install the unit in the following places:

- Sound sensitive areas (e.g. near a bedroom), so that the operation noise will cause no trouble.

Note: If the sound is measured under actual installation conditions, the measured value might be higher than the sound pressure level mentioned in Sound spectrum in the data book due to environmental noise and sound reflections.



INFORMATION

The sound pressure level is less than 70 dBA.

- In places where a mineral oil mist, spray or vapour may be present in the atmosphere. Plastic parts may deteriorate and fall off or cause water leakage.

It is NOT recommended to install the unit in the following places because it may shorten the life of the unit:

- Where the voltage fluctuates a lot
- In vehicles or vessels
- Where acidic or alkaline vapour is present

Seaside installation. Make sure the outdoor unit is NOT directly exposed to sea winds. This is to prevent corrosion caused by high levels of salt in the air, which might shorten the life of the unit.

Install the outdoor unit away from direct sea winds.

Example: Behind the building.

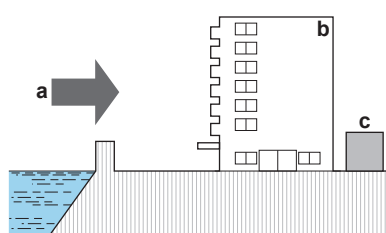

- a Sea wind
- b Building
- c Outdoor unit

If the outdoor unit is exposed to direct sea winds, install a windbreaker.

- Height of windbreaker $\geq 1.5 \times$ height of outdoor unit
- Mind the service space requirements when installing the windbreaker.

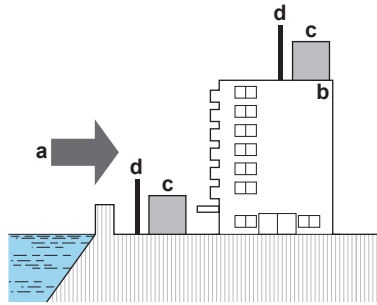

- a Sea wind
- b Building
- c Outdoor unit
- d Windbreaker

The outdoor unit is designed for outdoor installation only, and for ambient temperatures within the following ranges (unless otherwise specified in the operation manual of the connected indoor unit):

DX operation range	
Cooling mode	Heating mode
-10~46°C DB	-15~24°C DB

DHW operation range
-15~43°C DB

6.1.2 Additional installation site requirements of the outdoor unit in cold climates

Protect the outdoor unit against direct snowfall and take care that the outdoor unit is NEVER snowed up.

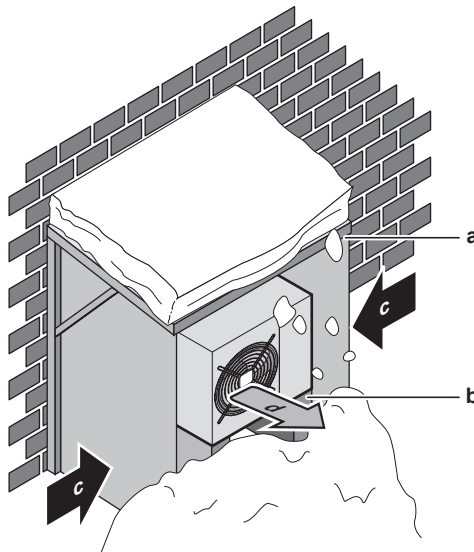

- a Snow cover or shed
- b Pedestal
- c Prevailing wind direction
- d Air outlet

It is recommended to provide at least 150 mm of free space below the unit (300 mm for heavy snowfall areas). Additionally, make sure the unit is positioned at least 100 mm above the maximum expected level of snow. If necessary, construct a pedestal. See "6.3 Mounting the outdoor unit" [▶ 27] for more details.

In heavy snowfall areas it is very important to select an installation site where the snow will NOT affect the unit. If lateral snowfall is possible, make sure that the heat exchanger coil is NOT affected by the snow. If necessary, install a snow cover or shed and a pedestal.

6.2 Opening the unit

6.2.1 About opening the unit

At certain times, you have to open the unit. **Example:**

- When connecting the refrigerant piping
- When connecting the electrical wiring
- When maintaining or servicing the unit



DANGER: RISK OF ELECTROCUTION

Do NOT leave the unit unattended when the service cover is removed.

6.2.2 To open the outdoor unit



DANGER: RISK OF ELECTROCUTION



DANGER: RISK OF BURNING/SCALDING

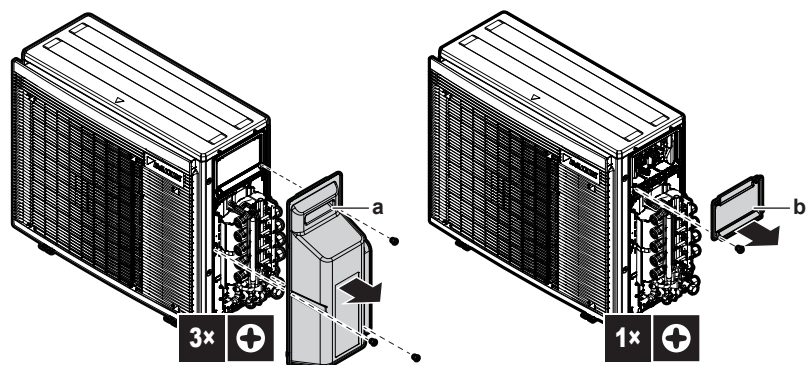

- a Service cover
- b Switch box cover

6.3 Mounting the outdoor unit

6.3.1 About mounting the outdoor unit

When

The outdoor and indoor unit must be mounted before the refrigerant piping can be connected.

Typical workflow

Mounting the outdoor unit typically consists of the following stages:

- 1 Providing the installation structure.
- 2 Installing the outdoor unit.
- 3 Providing drainage.
- 4 Protecting the unit against snow and wind by installing a snow cover and baffle plates. See "6.1 Preparing the installation site" [▶ 23].

6.3.2 Precautions when mounting the outdoor unit



INFORMATION

Also read the precautions and requirements in the following chapters:

- "2 General safety precautions" [▶ 7]
- "6.1 Preparing the installation site" [▶ 23]

6.3.3 To provide the installation structure

Check the strength and level of the installation ground so that the unit will not cause any operating vibration or noise.

Use a vibration-proof rubber (field supply) in cases where vibrations may be transmitted to the building.

The unit may be installed directly on a concrete veranda or another solid surface as long as it provides proper drainage.

Fix the unit securely by means of foundation bolts in accordance with the foundation drawing.

Prepare 4 sets of M8 or M10 anchor bolts, nuts and washers (field supply).

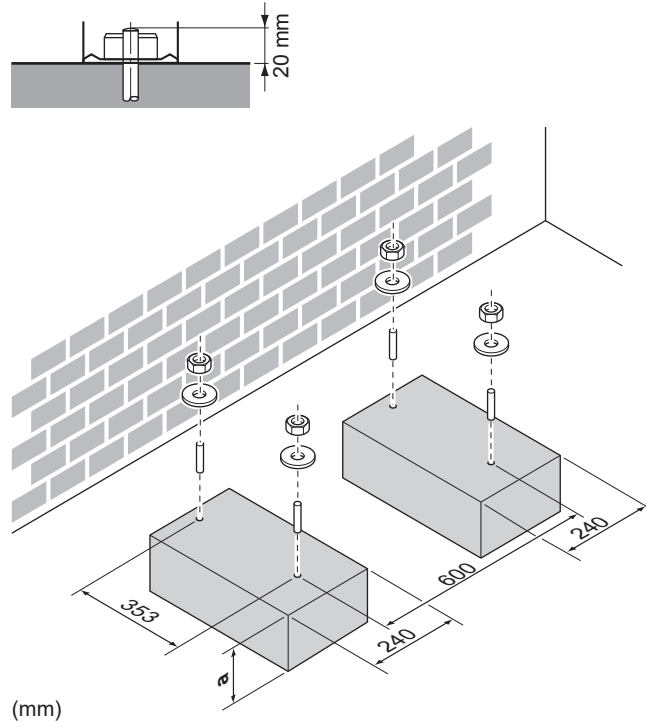

a 100 mm above expected level of snow

6.3.4 To install the outdoor unit

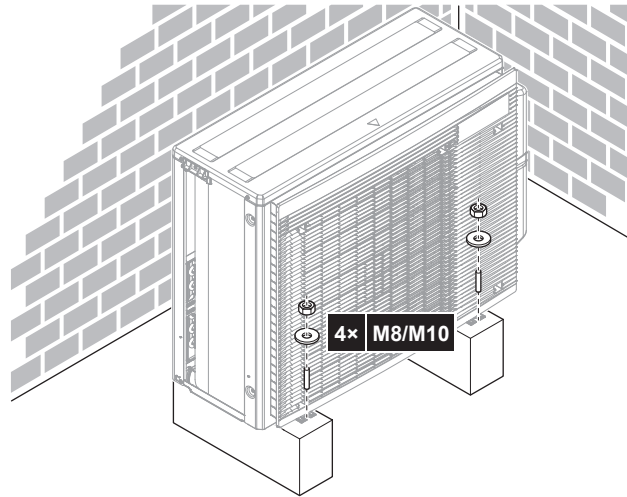

6.3.5 To provide drainage

- Make sure that condensation water can be evacuated properly.
- Install the unit on a base to make sure that there is proper drainage in order to avoid ice accumulation.
- Prepare a water drainage channel around the foundation to drain waste water away from the unit.
- Avoid drain water flowing over the footpath, so that it does NOT become slippery in case of ambient freezing temperatures.
- If you install the unit on a frame, install a waterproof plate within 150 mm of the bottom side of the unit in order to prevent water from getting into the unit and to avoid drain water dripping (see the following figure).

**NOTICE**

In cold areas, do NOT use a drain socket, hose and caps (large, small) with the outdoor unit. Take adequate measures so that the evacuated condensate CANNOT freeze.

**NOTICE**

If the drain holes of the outdoor unit are blocked up by a mounting base or floor surface, place additional foot bases ≤ 30 mm under the outdoor unit's feet.

- Use a drain socket for drainage if necessary.

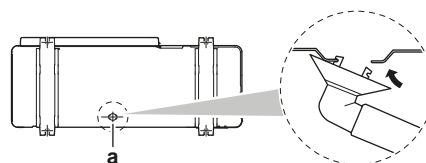

a Drain hole

To close the drain holes and attach the drain socket

- 1 Install drain caps (accessory h) and (accessory g). Make sure the edges of the drain caps close off the holes completely.
- 2 Install the drain socket.

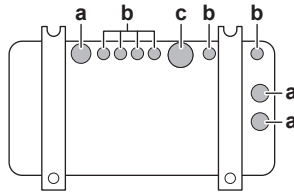

- a Drain hole. Install a drain cap (large).
- b Drain hole. Install a drain cap (small).
- c Drain hole for drain socket

6.3.6 To prevent the outdoor unit from falling over

In case the unit is installed in places where strong wind can tilt the unit, take following measure:

- 1 Prepare 2 cables as indicated in the following illustration (field supply).
- 2 Place the 2 cables over the outdoor unit.
- 3 Insert a rubber sheet between the cables and the outdoor unit to prevent the cables from scratching the paint (field supply).
- 4 Attach the ends of the cables.
- 5 Tighten the cables.

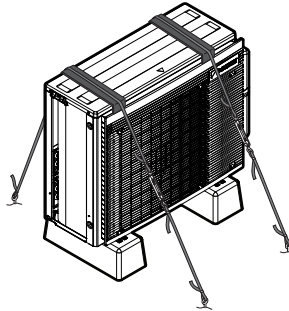

7 Piping installation

In this chapter

7.1	Preparing refrigerant piping	31
7.1.1	Refrigerant piping requirements	31
7.1.2	Refrigerant piping insulation	32
7.1.3	Refrigerant piping length and height difference	33
7.2	Connecting the refrigerant piping	34
7.2.1	About connecting the refrigerant piping	34
7.2.2	Precautions when connecting the refrigerant piping	35
7.2.3	Guidelines when connecting the refrigerant piping	36
7.2.4	Pipe bending guidelines	37
7.2.5	To flare the pipe end	37
7.2.6	Connections between outdoor and indoor unit using reducers	37
7.2.7	Using the stop valve and service port	40
7.2.8	To connect the refrigerant piping to the outdoor unit	41
7.2.9	To install sound insulation	42
7.3	Checking the refrigerant piping	42
7.3.1	About checking the refrigerant piping	42
7.3.2	Precautions when checking the refrigerant piping	43
7.3.3	To check for leaks	43
7.3.4	To perform vacuum drying	44

7.1 Preparing refrigerant piping

7.1.1 Refrigerant piping requirements



CAUTION

Piping and joints of a split system shall be made with permanent joints when inside an occupied space except joints directly connecting the piping to the indoor units.



CAUTION

- When **mechanical** connectors are re-used indoors, renew the sealing parts.
- When **flared joints** are re-used indoors, re-make the flared part.



NOTICE

The piping and other pressure-containing parts shall be suitable for refrigerant. Use phosphoric acid deoxidised seamless copper for refrigerant piping.



INFORMATION

Also read the precautions and requirements in the "[2 General safety precautions](#)" [▶ 7].

- Foreign materials inside pipes (including oils for fabrication) must be ≤ 30 mg/10 m.

Refrigerant piping diameter

5MWXM68A2V1B9	
Liquid piping	Gas piping
5× $\varnothing 6.4$ mm (1/4")	2× $\varnothing 9.5$ mm (3/8") 2× $\varnothing 12.7$ mm (1/2") 1× $\varnothing 15.9$ mm (5/8")

5MWXM90A2V1B9	
Liquid piping	Gas piping
5× Ø6.4 mm (1/4")	1× Ø9.5 mm (3/8") 1× Ø12.7 mm (1/2") 3× Ø15.9 mm (5/8")

**INFORMATION**

Usage of reducers might be required based on the indoor unit. See ["7.2.6 Connections between outdoor and indoor unit using reducers"](#) [▶ 37] for more information.

Refrigerant piping material**Piping material**

Phosphoric acid deoxidised seamless copper

Flare connections

Only use annealed material.

Piping temper grade and thickness

Outer diameter (Ø)	Temper grade	Thickness (t) ^(a)	
6.4 mm (1/4") 9.5 mm (3/8") 12.7 mm (1/2")	Annealed (O)	≥0.8 mm	
15.9 mm (5/8")		≥1 mm	

^(a) Depending on the applicable legislation and the maximum working pressure of the unit (see "PS High" on the unit name plate), larger piping thickness might be required.

7.1.2 Refrigerant piping insulation

- Use polyethylene foam as insulation material:
 - with a heat transfer rate between 0.041 and 0.052 W/mK (0.035 and 0.045 kcal/mh°C)
 - with a heat resistance of at least 120°C
- Insulation thickness:

Pipe outer diameter (Ø _p)	Insulation inner diameter (Ø _i)	Insulation thickness (t)
6.4 mm (1/4")	8~10 mm	≥10 mm
9.5 mm (3/8")	12~15 mm	≥13 mm
12.7 mm (1/2")	14~16 mm	≥13 mm
15.9 mm (5/8")	17~20 mm	≥13 mm



If the temperature is higher than 30°C and the humidity is higher than RH 80%, the thickness of the insulation materials should be at least 20 mm to prevent condensation on the surface of the insulation.

7.1.3 Refrigerant piping length and height difference

The shorter the refrigerant piping, the better the performance of the system.

The piping length and height differences must comply with the following requirements.

Shortest allowable length per room is 3 m.

For combination...	...refrigerant piping length to each indoor unit is:	...refrigerant piping total length is:
DX + 5MWXM90-A	≤25 m	≤75 m
DHW + 5MWXM90-A	≤30 m	
DX + 5MWXM68-A	≤25 m	≤60 m
DHW + 5MWXM68-A	≤30 m	
FBA71, 100 + 5MWXM68	≤30 m	$30 + 0.64 \times \text{DHW length}$
FBA71, 100, 125 + 5MWXM90	≤40 m	$40 + 0.64 \times \text{DHW length}$

Outdoor unit installed HIGHER than indoor unit		
	Height difference outdoor-indoor	Height difference indoor-indoor
DX	≤15 m	≤7.5 m
DHW	≤30 m	
FBA71, 100, 125		

Outdoor unit installed LOWER than at least 1 indoor unit		
	Height difference outdoor-indoor	Height difference indoor-indoor
DX	≤7.5 m	≤15 m
DHW	≤15 m	
FBA71, 100, 125	≤30 m	



INFORMATION

If you connect the FBA unit with a height difference between the outdoor and indoor unit <15 m, slide the switch SW5-2 to the ON side, see the procedure below.

To turn the switch SW5-2 ON

- 1 Remove the switch cover on the service PCB.
- 2 Slide switch SW5-2 to the ON side.

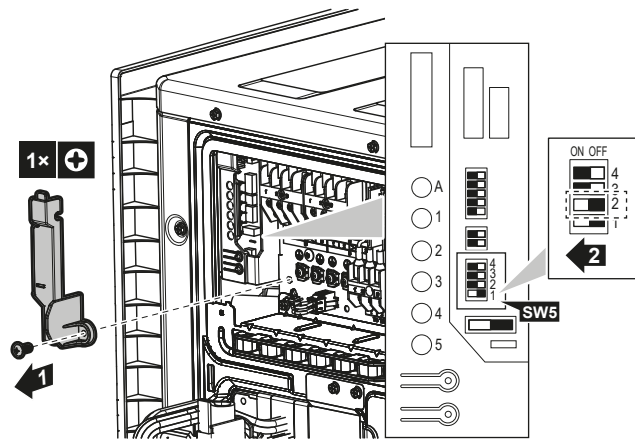

7.2 Connecting the refrigerant piping



CAUTION

- No brazing or welding on site for units with R32 refrigerant charge during shipment.
- During installation of the refrigeration system, joining of parts with at least one part charged shall be performed taking into account the following requirements: inside occupied spaces non-permanent joints are NOT allowed for R32 refrigerant except for site made joints directly connecting the indoor unit to piping. Site made joints directly connecting piping to indoor units shall be of non-permanent type.



CAUTION

Do NOT connect the embedded branch piping and the outdoor unit when only carrying out piping work without connecting the indoor unit in order to add another indoor unit later.

7.2.1 About connecting the refrigerant piping

Before connecting the refrigerant piping

Make sure the outdoor and indoor unit are mounted.

Typical workflow

Connecting the refrigerant piping involves:

- Connecting the refrigerant piping to the indoor unit
- Connecting the refrigerant piping to the outdoor unit
- Insulating the refrigerant piping
- Keeping in mind the guidelines for:
 - Pipe bending
 - Flaring pipe ends
 - Using the stop valves

7.2.2 Precautions when connecting the refrigerant piping

**INFORMATION**

Also read the precautions and requirements in the following chapters:

- "2 General safety precautions" [▶ 7]
- "7.1 Preparing refrigerant piping" [▶ 31]

**DANGER: RISK OF BURNING/SCALDING****NOTICE**

- Use the flare nut fixed to the main unit.
- To prevent gas leakage, apply refrigeration oil only to the inside of the flare. Use refrigeration oil for R32 (FW68DA).
- Do NOT reuse joints.

**NOTICE**

- Do NOT use mineral oil on flared part.
- Do NOT reuse piping from previous installations.
- NEVER install a drier to this R32 unit to guarantee its lifetime. The drying material may dissolve and damage the system.

**NOTICE**

- Use the flare nut fixed to the main unit.
- To prevent gas leakage, apply refrigeration oil only to the inside of the flare. Use refrigeration oil for R32 (**Example:** FW68DA, SUNISO Oil).
- Do NOT reuse joints.

**NOTICE**

Take the following precautions on refrigerant piping into account:

- Avoid anything but the designated refrigerant to get mixed into the refrigerant cycle (e.g. air).
- Only use R32 when adding refrigerant.
- Only use installation tools (e.g. manifold gauge set) that are exclusively used for R32 installations to withstand the pressure and to prevent foreign materials (e.g. mineral oils and moisture) from mixing into the system.
- Install the piping so that the flare is NOT subjected to mechanical stress.
- Do NOT leave pipes unattended at the site. If the installation is NOT done within 1 day, protect the piping as described in the following table to prevent dirt, liquid or dust from entering the piping.
- Use caution when passing copper tubes through walls (see figure below).

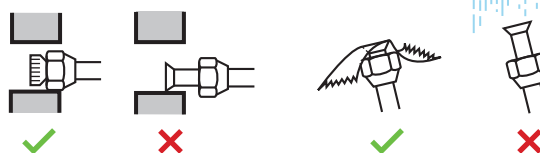

Unit	Installation period	Protection method
Outdoor unit	>1 month	Pinch the pipe
	<1 month	Pinch or tape the pipe
Indoor unit	Regardless of the period	



NOTICE

Do NOT open the refrigerant stop valve before checking the refrigerant piping. When you need to charge additional refrigerant it is recommended to open the refrigerant stop valve after charging.



WARNING

Connect the refrigerant piping securely before running the compressor. If the refrigerant piping is NOT connected and the stop valve is open when the compressor is run, air will be sucked in. This will cause abnormal pressure in the refrigeration cycle, which may result in equipment damage and even injury.



NOTICE

Even if the stop valve is fully closed, the refrigerant may slowly leak out. Do NOT leave the flare nut removed for long period of time.

7.2.3 Guidelines when connecting the refrigerant piping

Take the following guidelines into account when connecting pipes:

- Coat the flare inner surface with refrigerant oil for R32 (FW68DA) when connecting a flare nut. Tighten 3 or 4 turns by hand, before tightening firmly.

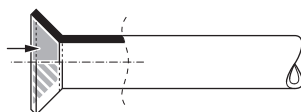

- ALWAYS use 2 wrenches together when loosening a flare nut.
- ALWAYS use a spanner and torque wrench together to tighten the flare nut when connecting the piping. This to prevent nut cracking and leaks.

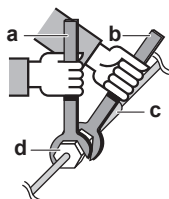

- a Torque wrench
- b Spanner
- c Piping union
- d Flare nut

Piping size (mm)	Tightening torque (N•m)	Flare dimensions (A) (mm)	Flare shape (mm)
∅6.4	15~17	8.7~9.1	
∅9.5	33~39	12.8~13.2	
∅12.7	50~60	16.2~16.6	
∅15.9	62~75	19.3~19.7	

7.2.4 Pipe bending guidelines

Use a pipe bender for bending. All pipe bends should be as gentle as possible (bending radius should be 30~40 mm or larger).

7.2.5 To flare the pipe end



CAUTION

- Incomplete flaring may cause refrigerant gas leakage.
- Do NOT re-use flares. Use new flares to prevent refrigerant gas leakage.
- Use flare nuts that are included with the unit. Using different flare nuts may cause refrigerant gas leakage.

- 1 Cut the pipe end with a pipe cutter.
- 2 Remove burrs with the cut surface facing down so that the chips do NOT enter the pipe.

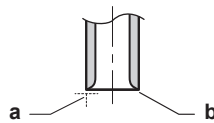

- a Cut exactly at right angles.
- b Remove burrs.

- 3 Remove the flare nut from the stop valve and put the flare nut on the pipe.
- 4 Flare the pipe. Set exactly at the position as shown in the following figure.



	Flare tool for R32 (clutch type)	Conventional flare tool	
		Clutch type (Ridgid-type)	Wing nut type (Imperial-type)
A	0~0.5 mm	1.0~1.5 mm	1.5~2.0 mm

- 5 Check that the flaring is properly made.

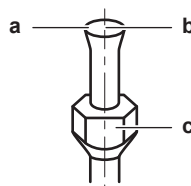

- a Flare's inner surface MUST be flawless.
- b The pipe end MUST be evenly flared in a perfect circle.
- c Make sure the flare nut is fitted.

7.2.6 Connections between outdoor and indoor unit using reducers

Outdoor unit	Total indoor air conditioning units capacity class that can be connected to this outdoor unit
5MWXM68	≤11 kW
5MWXM90	≤15.6 kW

**INFORMATION**

This outdoor unit can be connected in the following ways:

- To a DHW tank and up to 4 indoor units (DX)
- To a DHW tank only
- To 2 to 4 indoor units (DX) only.

⇒ **Note:** Connecting only 1 indoor unit is NOT allowed, except when using model FBA71 or 100 with unit 5MWXM68, or model FBA71, 100, or 125 with unit 5MWXM90.

5MWXM68

Port	Dimensions	Class	Reducer
A+B	Liquid Ø6.4 mm Gas Ø9.5 mm	15, 20, 25, 35, 42 ^(a)	—
C+D	Liquid Ø6.4 mm Gas Ø12.7 mm	15, 20, 25, 35, 42 ^(a)	2,4
		42 ^(b) , 50, 60	—
		71 ^(c) , 100 ^(c)	Use option ASYCPIR-MD1
Tank	Liquid Ø6.4 mm	90, 120	Field supply ^(d)
	Gas Ø15.9 mm	180, 230	—

^(a) Excluding FTXJ.

^(b) Only for FTXJ.

^(c) For connection of the FBA use D port only.

^(d) In the case of connecting 5MWXM-A9 to EKHWET-BV3 unit, please use appropriate field-supplied reducers.

5MWXM90

Port	Dimensions	Class	Reducer
A	Liquid Ø6.4 mm Gas Ø9.5 mm	15, 20, 25, 35, 42 ^(a)	—
B	Liquid Ø6.4 mm Gas Ø12.7 mm	15, 20, 25, 35, 42 ^(a)	2, 4
		42 ^(b) , 50, 60	—
C+D	Liquid Ø6.4 mm Gas Ø15.9 mm	15, 20, 25, 35, 42 ^(a)	5, 6
		42 ^(b) , 50, 60	3, 1
		71 ^(c)	—
		71 ^(d) , 100 ^(d) , 125 ^(d)	Use option ASYCPIR-MD1
To tank	Liquid Ø6.4 mm	90, 120	Field supply ^(e)
	Gas Ø15.9 mm	180, 230	—

^(a) Excluding FTXJ.

^(b) Only for FTXJ.

^(c) Only for FTXM71A.

^(d) For connection of the FBA use D port only.

^(e) In the case of connecting 5MWXM-A9 to EKHWET-BV3 unit, please use appropriate field-supplied reducers.

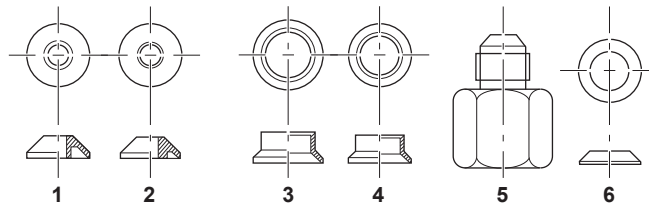

Reducer type	Connection
1	Ø15.9 mm → Ø12.7 mm
2	Ø12.7 mm → Ø9.5 mm
3	Ø15.9 mm → Ø12.7 mm
4	Ø12.7 mm → Ø9.5 mm
5	Ø15.9 mm → Ø9.5 mm
6	Ø15.9 mm → Ø9.5 mm

Connection examples:

- Connecting a Ø12.7 mm pipe to a Ø15.9 mm gas pipe connection port

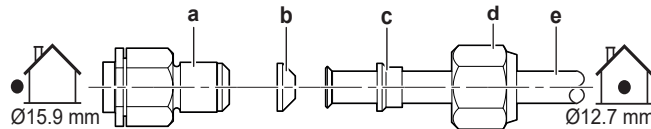

- a Outdoor unit connection port
- b Reducer no. 1
- c Reducer no. 3
- d Flare nut for Ø15.9 mm
- e Inter-unit piping

- Connecting a Ø9.5 mm pipe to a Ø15.9 mm gas pipe connection port

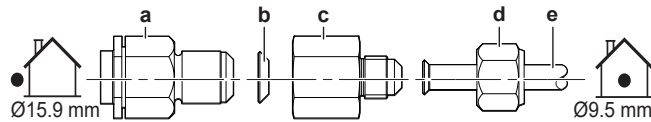

- a Outdoor unit connection port
- b Reducer no. 6
- c Reducer no. 5
- d Flare nut for Ø9.5 mm
- e Inter-unit piping

- Connecting a Ø9.5 mm pipe to a Ø12.7 mm gas pipe connection port

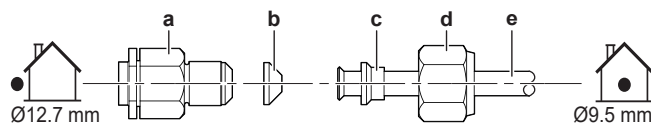

- a Outdoor unit connection port
- b Reducer no. 2
- c Reducer no. 4
- d Flare nut for Ø12.7 mm
- e Inter-unit piping



NOTICE

To prevent gas leakage, apply refrigeration oil for R32 (FW68DA):

- Ø9.5 mm → Ø15.9 mm, to both sides of the Reducer 6 (b) AND to the inner surface of the flare.
- Ø12.7 mm → Ø15.9 mm or Ø9.5 mm → Ø12.7 mm, to both sides of Reducer 1 or 2 (b).

Flare nut for (mm)	Tightening torque (N•m)
Ø9.5	33~39
Ø12.7	50~60
Ø15.9	62~75

NOTICE



Use an appropriate wrench to avoid damaging the connection thread by overtightening the flare nut. Be careful NOT to overtighten the nut, or the smaller pipe may be damaged (about 2/3~1× the normal torque).

7.2.7 Using the stop valve and service port

CAUTION



Do NOT open the valves before flaring is complete. This would cause refrigerant gas leakage.

To handle the stop valve

Take the following guidelines into account:

- The stop valves are factory closed.
- The following figure shows the stop valve parts required when handling the valve.

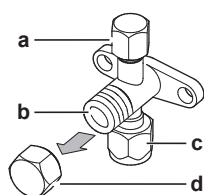

- a Service port and service port cap
- b Valve stem
- c Field piping connection
- d Stem cap

- Keep both stop valves open during operation.
- Do NOT apply excessive force to the valve stem. Doing so may break the valve body.

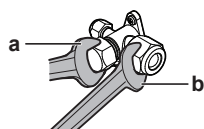

- a Spanner
- b Torque wrench

- When it is expected that the operating pressure will be low (e.g. when cooling will be performed while the outside air temperature is low), sufficiently seal the flare nut in the stop valve on the gas line with silicon sealant to prevent freezing.

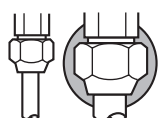

■ Silicon sealant, make sure there is no gap.

To open/close the stop valve

- 1 Remove the stop valve cover.

- 2 Insert a hexagon wrench (liquid side: 4 mm, gas side: 6 mm) into the valve stem and turn the valve stem:

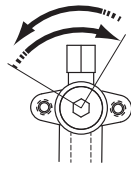

Counterclockwise to open
Clockwise to close

- 3 When the stop valve CANNOT be turned any further, stop turning.
- 4 Install the stop valve cover.

Result: The valve is now open/closed.

To handle the stem cap

- The stem cap is sealed where indicated with the arrow. Do NOT damage it.

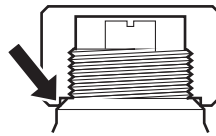

- After handling the stop valve, tighten the stem cap, and check for refrigerant leaks.

Stem cap		Width across flats (mm)	Tightening torque (N·m)
DX connection side	Liquid side	19	18~20
	Gas side	22	21~28
DHW connection side	Liquid side	17	15~17
	Gas side	27	48~59

To handle the service cap

- ALWAYS use a charge hose equipped with a valve depressor pin, since the service port is a Schrader type valve.
- After handling the service port, tighten the service port cap, and check for refrigerant leaks.

Item	Tightening torque (N·m)
Service port cap	11~14

7.2.8 To connect the refrigerant piping to the outdoor unit

- **Piping length.** Keep field piping as short as possible.
 - **Piping protection.** Protect the field piping against physical damage.
- 1 Connect the liquid refrigerant connection from the indoor unit to the liquid stop valve of the outdoor unit.

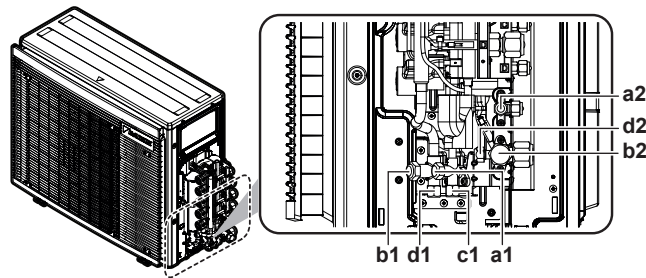

To air-conditioning unit:

- a1** Liquid stop valve
- b1** Gas stop valve
- c1** Liquid service port
- d1** Gas service port

To tank:

- a2** Liquid stop valve
- b2** Gas stop valve
- d2** Gas service port

- 2 Connect the gas refrigerant connection from the indoor unit to the gas stop valve of the outdoor unit.



NOTICE

It is recommended that the refrigerant piping between indoor and outdoor unit is installed in a ducting or the refrigerant piping is wrapped with finishing tape.

7.2.9 To install sound insulation

After connecting piping, mount sound insulation (accessory k) on the outdoor unit using two screws (accessory l) as it is shown in picture below.

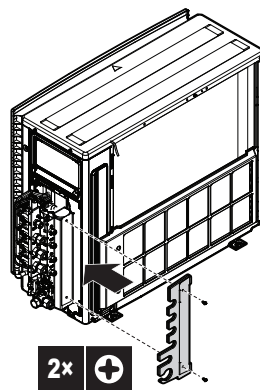

7.3 Checking the refrigerant piping

7.3.1 About checking the refrigerant piping

The outdoor unit's **internal** refrigerant piping has been factory tested for leaks. You only have to check the outdoor unit's **external** refrigerant piping.

Before checking the refrigerant piping

Make sure the refrigerant piping is connected between the outdoor unit and the indoor unit.

Typical workflow

Checking the refrigerant piping typically consists of the following stages:

- 1 Checking for leaks in the refrigerant piping.

- 2 Performing vacuum drying to remove all moisture, air or nitrogen from the refrigerant piping.

If there is a possibility of moisture being present in the refrigerant piping (for example, water may have entered the piping), first carry out the vacuum drying procedure below until all moisture has been removed.

7.3.2 Precautions when checking the refrigerant piping



INFORMATION

Also read the precautions and requirements in the following chapters:

- "2 General safety precautions" [▶ 7]
- "7.1 Preparing refrigerant piping" [▶ 31]



NOTICE

Use a 2-stage vacuum pump with a non-return valve that can evacuate to a gauge pressure of -100.7 kPa (-1.007 bar)(5 Torr absolute). Make sure the pump oil does not flow oppositely into the system while the pump is not working.



NOTICE

Use this vacuum pump for R32 exclusively. Using the same pump for other refrigerants may damage the pump and the unit.



NOTICE

- Connect the vacuum pump to the service port of the gas stop valve.
- Make sure that the gas stop valve and liquid stop valve are firmly closed before performing the leak test or vacuum drying.

7.3.3 To check for leaks



NOTICE

Do NOT exceed the unit's maximum working pressure (see "PS High" on the unit name plate).



NOTICE

ALWAYS use a recommended bubble test solution from your wholesaler.

NEVER use soap water:

- Soap water may cause cracking of components, such as flare nuts or stop valve caps.
- Soap water may contain salt, which absorbs moisture that will freeze when the piping gets cold.
- Soap water contains ammonia which may lead to corrosion of flared joints (between the brass flare nut and the copper flare).

- 1 Charge the system with nitrogen gas up to a gauge pressure of at least 200 kPa (2 bar). It is recommended to pressurize to 3000 kPa (30 bar) or higher (depending on local legislation) to detect small leaks.
- 2 Check for leaks by applying the bubble test solution to all connections.
- 3 Discharge all nitrogen gas.

7.3.4 To perform vacuum drying



DANGER: RISK OF EXPLOSION

Do NOT open the stop valves before the vacuum drying is finished.

Connect the vacuum pump and manifold as follows:

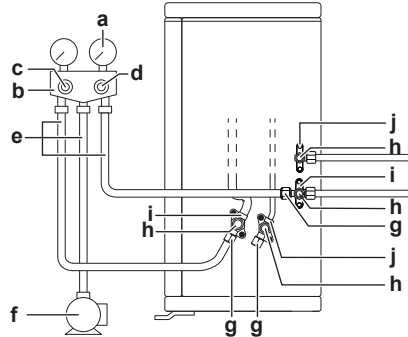

- a Pressure meter
- b Gauge manifold
- c Low-pressure valve (Lo)
- d High-pressure valve (Hi)
- e Charging hoses
- f Vacuum pump
- g Service port
- h Valve caps
- i Gas stop valve
- j Liquid stop valve



NOTICE

Connect the vacuum pump to **both** the service ports of the gas stop valves.

- 1 Vacuum the system until the pressure on the manifold indicates -0.1 MPa (-1 bar).
- 2 Leave as is for 4-5 minutes and check the pressure:

If the pressure...	Then...
Does not change	There is no moisture in the system. This procedure is finished.
Increases	There is moisture in the system. Go to the next step.

- 3 Vacuum the system for at least 2 hours to a manifold pressure of -0.1 MPa (-1 bar).
- 4 After turning the pump OFF, check the pressure for at least 1 hour.
- 5 If you do NOT reach the target vacuum or CANNOT maintain the vacuum for 1 hour, do the following:
 - Check for leaks again.
 - Perform vacuum drying again.



NOTICE

Make sure to open the stop valves after installing the refrigerant piping and performing vacuum drying. Running the system with the stop valves closed may break the compressor.

**INFORMATION**

After opening the stop valve, it is possible that the pressure in the refrigerant piping does NOT increase. This might be caused by e.g. the closed state of the expansion valve in the outdoor unit circuit, but does NOT present any problem for correct operation of the unit.

8 Charging refrigerant

In this chapter

8.1	About charging refrigerant.....	46
8.2	About the refrigerant	47
8.3	Precautions when charging refrigerant	48
8.4	To determine the additional refrigerant amount	48
8.5	To determine the complete recharge amount	49
8.6	To charge additional refrigerant	49
8.7	To fix the fluorinated greenhouse gases label.....	49
8.8	To check refrigerant piping joints for leaks after charging refrigerant	50

8.1 About charging refrigerant

The outdoor unit is factory charged with refrigerant, but in some cases the following might be necessary:

What	When
Charging additional refrigerant	When the total liquid piping length is more than specified (see later).
Completely recharging refrigerant	Example: <ul style="list-style-type: none"> ▪ When relocating the system. ▪ After a leak.

Charging additional refrigerant

Before charging additional refrigerant, make sure the outdoor unit's **external** refrigerant piping is checked (leak test, vacuum drying).



INFORMATION

Depending on the units and/or the installation conditions, it might be necessary to connect electrical wiring before you can charge refrigerant.

Typical workflow – Charging additional refrigerant typically consists of the following stages:

- 1 Determining if and how much you have to charge additionally.
- 2 If necessary, charging additional refrigerant.
- 3 Filling in the fluorinated greenhouse gases label, and fixing it to the inside of the outdoor unit.

Completely recharging refrigerant

Before completely recharging refrigerant, make sure the following is done:

- 1 All refrigerant is recovered from the system.
- 2 The outdoor unit's **external** refrigerant piping is checked (leak test, vacuum drying).
- 3 Vacuum drying on the outdoor unit's **internal** refrigerant piping is performed.



NOTICE

Before completely recharging, perform vacuum drying on the outdoor unit's **internal** refrigerant piping as well.

Typical workflow – Completely recharging refrigerant typically consists of the following stages:

- 1 Determining how much refrigerant to charge.
- 2 Charging refrigerant.
- 3 Filling in the fluorinated greenhouse gases label, and fixing it to the inside of the outdoor unit.

8.2 About the refrigerant

This product contains fluorinated greenhouse gases. Do NOT vent gases into the atmosphere.

Refrigerant type: R32

Global warming potential (GWP) value: 675

Periodical inspections for refrigerant leaks may be required depending on the applicable legislation. Contact your installer for more information.



A2L

WARNING: MILDLY FLAMMABLE MATERIAL

The refrigerant inside this unit is mildly flammable.



WARNING

- The refrigerant inside the unit is mildly flammable, but normally does NOT leak. If the refrigerant leaks in the room and comes in contact with fire from a burner, a heater, or a cooker, this may result in fire, or the formation of a harmful gas.
- Turn OFF any combustible heating devices, ventilate the room, and contact the dealer where you purchased the unit.
- Do NOT use the unit until a service person confirms that the part from which the refrigerant leaked has been repaired.



WARNING

The appliance shall be stored so as to prevent mechanical damage and in a well-ventilated room without continuously operating ignition sources (e.g. open flames, an operating gas appliance, or an operating electric heater). The room size shall be as specified in the General safety precaution.



WARNING

- Do NOT pierce or burn refrigerant cycle parts.
- Do NOT use cleaning materials or means to accelerate the defrosting process other than those recommended by the manufacturer.
- Be aware that the refrigerant inside the system is odourless.



WARNING

NEVER directly touch any accidental leaking refrigerant. This could result in severe wounds caused by frostbite.



NOTICE

Applicable legislation on **fluorinated greenhouse gases** requires that the refrigerant charge of the unit is indicated both in weight and CO₂ equivalent.

Formula to calculate the quantity in CO₂ equivalent tonnes: GWP value of the refrigerant × total refrigerant charge [in kg]/1000

Contact your installer for more information.

8.3 Precautions when charging refrigerant



INFORMATION

Also read the precautions and requirements in the following chapters:

- "2 General safety precautions" [▶ 7]
- "7.1 Preparing refrigerant piping" [▶ 31]

8.4 To determine the additional refrigerant amount

In case of connection FBA71, 100, 125

1 Calculate the **total required charge (RT)** by using the following formula:

- **5MWXM68:** $RT = 0.9 \text{ kg} + 0.055 \text{ (kg)} \times \text{FBA piping length (m)} + 0.02 \text{ (kg)} \times \text{DHW piping length (m)}$
- **5MWXM90:** $RT = 1.1 \text{ kg} + 0.055 \text{ (kg)} \times \text{FBA piping length (m)} + 0.02 \text{ (kg)} \times \text{DHW piping length (m)}$

Note: Total required charge cannot be higher than maximum allowable refrigerant charge amount.

Note: If difference between "total required charge" and nominal charge is >0 use the following formula instead:

2 Additional charge (R) = *total required charge* - *nominal charge* (for 90 class 2.4 kg, for 68 class 2.0 kg)

For connection with other indoor units

If the total liquid piping length is...	Then...
≤30 m	Do NOT add additional refrigerant.
>30 m	$R = (\text{total length (m) of liquid piping} - 30 \text{ m}) \times 0.020$ R=Additional charge (kg) (rounded in units of 0.1 kg)



INFORMATION

Piping length is the one-way length of liquid piping.

Maximum allowable refrigerant charge amount:

5MWXM68	2.6 kg
5MWXM90	3.3 kg

8.5 To determine the complete recharge amount



INFORMATION

If a complete recharge is necessary, the total refrigerant charge is: the factory refrigerant charge (see unit name plate) + the determined additional amount.

8.6 To charge additional refrigerant



WARNING

- Only use R32 as refrigerant. Other substances may cause explosions and accidents.
- R32 contains fluorinated greenhouse gases. Its global warming potential (GWP) value is 675. Do NOT vent these gases into the atmosphere.
- When charging refrigerant, ALWAYS use protective gloves and safety glasses.



NOTICE

To avoid compressor breakdown, do NOT charge more than the specified amount of refrigerant.

Prerequisite: Before charging refrigerant, make sure the refrigerant piping is connected and checked (leak test and vacuum drying).

- 1 Connect the refrigerant cylinder to the service port.
- 2 Charge the additional refrigerant amount.
- 3 Open the gas stop valve.

If pump down is needed in case of dismantling or relocating the system, see "16.2 To pump down" [▶ 72] for more details.

8.7 To fix the fluorinated greenhouse gases label

- 1 Fill in the label as follows:

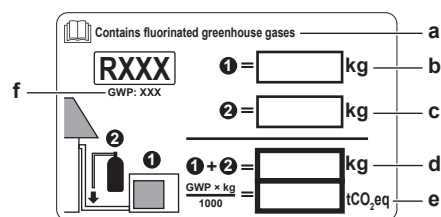

- If a multilingual fluorinated greenhouse gases label is delivered with the unit (see accessories), peel off the applicable language and stick it on top of **a**.
- Factory refrigerant charge: see unit name plate
- Additional refrigerant amount charged
- Total refrigerant charge
- Quantity of fluorinated greenhouse gases** of the total refrigerant charge expressed as tonnes CO₂ equivalent.
- GWP = Global Warming Potential



NOTICE

Applicable legislation on **fluorinated greenhouse gases** requires that the refrigerant charge of the unit is indicated both in weight and CO₂ equivalent.

Formula to calculate the quantity in CO₂ equivalent tonnes: GWP value of the refrigerant × total refrigerant charge [in kg] / 1000

Use the GWP value mentioned on the refrigerant charge label.

- 2 Fix the label on the inside of the outdoor unit near the gas and liquid stop valves.

8.8 To check refrigerant piping joints for leaks after charging refrigerant

- 1 Perform the leak tests see "[7.3 Checking the refrigerant piping](#)" [▶ 42].
- 2 Charge refrigerant.
- 3 Check for refrigerant leaks after charging (see below)

Tightness test of field-made refrigerant joints indoors

- 1 Use a leakage test method with a minimum sensitivity of 5 g of refrigerant/year. Test leaks using a pressure of at least 0.25 times the maximum working pressure (see "PS High" on the unit nameplate).

If a leak is detected

- 1 Recover the refrigerant, repair the joint, and repeat the test.

9 Electrical installation

In this chapter

9.1	About connecting the electrical wiring	51
9.1.1	Precautions when connecting the electrical wiring	51
9.1.2	Guidelines when connecting the electrical wiring	53
9.1.3	Specifications of standard wiring components	54
9.2	To connect the electrical wiring to the outdoor unit	55

9.1 About connecting the electrical wiring

Before connecting the electrical wiring

Make sure the refrigerant piping is connected and checked.

Typical workflow

Connecting the electrical wiring typically consists of the following stages:

- 1 Making sure the power supply system complies with the electrical specifications of the heat pump.
- 2 Connecting the electrical wiring to the outdoor unit.
- 3 Connecting the electrical wiring to the indoor unit.
- 4 Connecting the main power supply of the indoor unit.
- 5 Connecting the main power supply of the gas boiler.
- 6 Connecting the communication cable between the gas boiler and the indoor unit.
- 7 Connecting the user interface.
- 8 Connecting the shut-off valves.
- 9 Connecting the domestic hot water tank.
- 10 Connecting the alarm output.
- 11 Connecting the space heating ON/OFF output.
- 12 Connecting the safety thermostat.

9.1.1 Precautions when connecting the electrical wiring



DANGER: RISK OF ELECTROCUTION



DANGER: RISK OF ELECTROCUTION

All electrical parts (including thermistors) are powered by the power supply. Do NOT touch them with bare hands.



WARNING

- All wiring MUST be performed by an authorised electrician and MUST comply with the national wiring regulation.
- Make electrical connections to the fixed wiring.
- All components procured on-site and all electrical construction MUST comply with the applicable legislation.



WARNING

ALWAYS use multicore cable for power supply cables.



INFORMATION

Also read the precautions and requirements in the "[2 General safety precautions](#)" [[7](#)].



INFORMATION

Also read "[9.1.3 Specifications of standard wiring components](#)" [[54](#)].



WARNING

- If the power supply has a missing or wrong N-phase, equipment might break down.
- Establish proper earthing. Do NOT earth the unit to a utility pipe, surge absorber, or telephone earth. Incomplete earthing may cause electrical shocks.
- Install the required fuses or circuit breakers.
- Secure the electrical wiring with cable ties so that the cables do NOT come in contact with sharp edges or piping, particularly on the high-pressure side.
- Do NOT use taped wires, extension cords, or connections from a star system. They can cause overheating, electrical shocks or fire.
- Do NOT install a phase advancing capacitor, because this unit is equipped with an inverter. A phase advancing capacitor will reduce performance and may cause accidents.



WARNING

Use an all-pole disconnection type breaker with at least 3 mm between the contact point gaps that provides full disconnection under overvoltage category III.



WARNING

If the supply cord is damaged, it MUST be replaced by the manufacturer, its service agent or similarly qualified persons in order to avoid a hazard.



WARNING

Do NOT connect the power supply to the indoor unit. This could result in electrical shock or fire.



WARNING

- Do NOT use locally purchased electrical parts inside the product.
- Do NOT branch the power supply for the drain pump, etc. from the terminal block. This could result in electrical shock or fire.



WARNING

Keep the interconnection wiring away from copper pipes without thermal insulation as such pipes will be very hot.

9.1.2 Guidelines when connecting the electrical wiring



NOTICE

We recommend using solid (single-core) wires. If stranded wires are used, slightly twist the strands to consolidate the end of the conductor for either direct use in the terminal clamp or insertion in a round crimp-style terminal.

To prepare stranded conductor wire for installation

Method 1: Twisting conductor

- 1 Strip insulation (20 mm) from the wires.
- 2 Slightly twist the end of the conductor to create a "solid-like" connection.

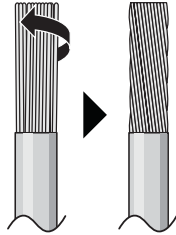

Method 2: Using round crimp-style terminal (recommended)

- 1 Strip insulation from wires and slightly twist the end of each wire.
- 2 Install a round crimp-style terminal on the end of the wire. Place the round crimp-style terminal on the wire up to the covered part and fasten the terminal with the appropriate tool.

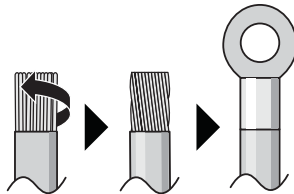

Use the following methods for installing wires:

Wire type	Installation method
Single-core wire Or Stranded conductor wire twisted to "solid-like" connection	<p>a Curled wire (single-core or twisted stranded conductor wire)</p> <p>b Screw</p> <p>c Flat washer</p>

Wire type	Installation method
Stranded conductor wire with round crimp-style terminal	<p> a Terminal b Screw c Flat washer Allowed NOT allowed </p>

Tightening torques

Item	Tightening torque (N•m)
M4 (X1M)	1.2
M4 (earth)	

- The earth wire between the wire retainer and the terminal must be longer than the other wires.

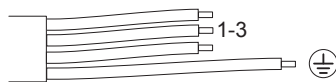

9.1.3 Specifications of standard wiring components

NOTICE
 For power supply cable, if stranded wires are used, make sure to use round crimp-style terminal.

Power supply	
Voltage	220~240 V
Frequency	50 Hz
Phase	1~
Current	25.2 A

Components	
Power supply cable	MUST comply with national wiring regulation 3-core cable Wire size based on the current, but not less than 4 mm ²
Interconnection cable (indoor↔outdoor or indoor↔user interface)	Only use harmonised wire providing double insulation and suitable for applicable voltage 4-core cable Minimum size 1.5 mm ²
Recommended circuit breaker	32 A
Earth leakage circuit breaker / residual current circuit breaker	MUST comply with national wiring regulation

Electrical equipment must comply with EN/IEC 61000-3-12, the European/International Technical Standard setting the limits for harmonic currents produced by equipment connected to public low-voltage systems with input current >16 A and ≤75 A per phase.

9.2 To connect the electrical wiring to the outdoor unit

- 1 Remove the switch box cover (1 screw).

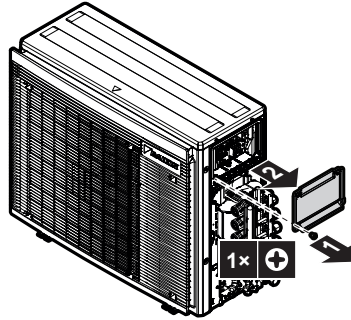

- 2 Strip insulation (20 mm) from the wires.

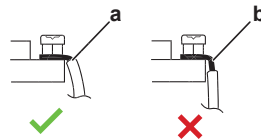

- a Strip wire end to this point
- b An excessive strip length may cause electrical shock or leakage

- 3 Connect the wires between the indoor and outdoor units so that the terminal numbers match. Make sure to match the symbols for piping and wiring.
- 4 Make sure to connect correct wiring to correct room.

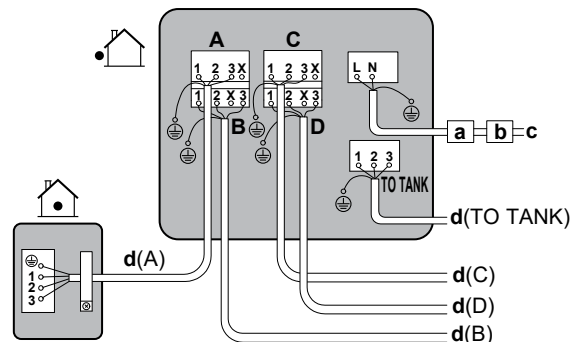

- A** Terminal for room A
- B** Terminal for room B
- C** Terminal for room C
- D** Terminal for room D
- TO TANK** Terminal for DHW tank
- a** Circuit breaker
- b** Residual current device
- c** Power supply wire
- d** Interconnection wire for room (A, B, C, D, TO TANK)

- 5 Tighten the terminal screws securely using a Phillips screwdriver.
- 6 Check that the wires do NOT disconnect by pulling them lightly.
- 7 Firmly secure the wire retainer using screws (accessory **f**) to avoid external stress on wire terminations.
- 8 Pass the wiring through the cutout on the bottom of the protection plate.

- 9 Make sure that the electrical wiring does NOT make contact with the gas piping.

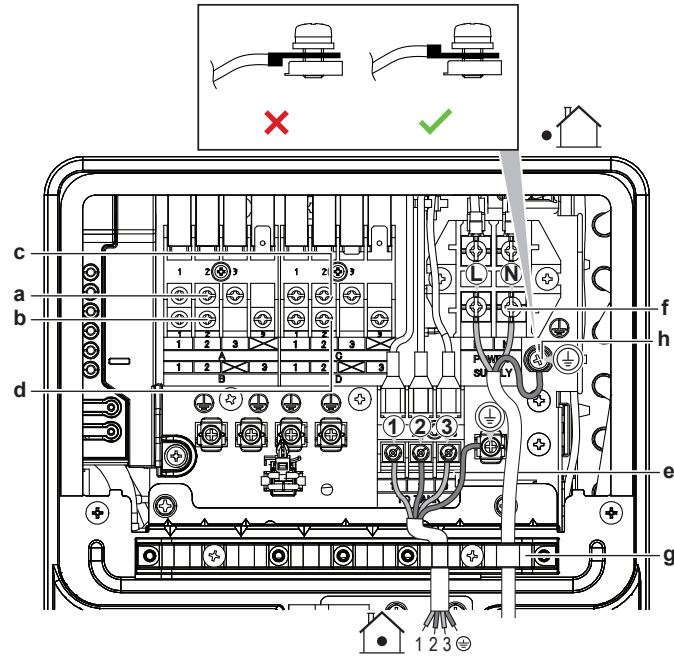

- a Terminal for indoor unit A
- b Terminal for indoor unit B
- c Terminal for indoor unit C
- d Terminal for indoor unit D
- e Terminal for DHW tank
- f Power supply terminal
- g Wire retainer
- h Earth wire

- 10 Reattach the switch box cover and the service cover.

10 Finishing the outdoor unit installation

10.1 To finish the outdoor unit installation



DANGER: RISK OF ELECTROCUTION

- Make sure that the system is earthed properly.
- Turn OFF the power supply before servicing.
- Install the switch box cover before turning ON the power supply.



NOTICE

It is recommended that the refrigerant piping between indoor and outdoor unit is installed in a ducting or the refrigerant piping is wrapped with finishing tape.

- 1 Insulate and fix the refrigerant piping and cables as follows:

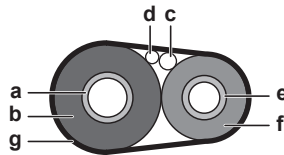

- a Gas pipe
- b Gas pipe insulation
- c Interconnection cable
- d Field wiring (if applicable)
- e Liquid pipe
- f Liquid pipe insulation
- g Finishing tape

- 2 Install the service cover.

10.2 To close the outdoor unit

- 1 Close the switch box cover.
- 2 Close the service cover.

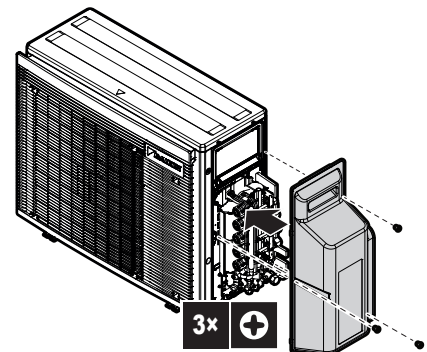
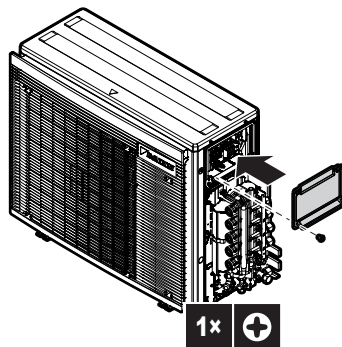

11 Configuration



INFORMATION

Following field settings are applicable only for direct expansion indoor units (DX). For the DHW tank field setting, refer to the installation manual of the DHW tank.

In this chapter

11.1	About standby electricity saving function.....	58
11.1.1	To turn ON standby electricity saving function.....	58
11.2	About priority room function.....	59
11.2.1	To set the priority room function.....	59
11.3	About night quiet mode.....	59
11.3.1	To turn ON the night quiet mode.....	59
11.4	About heat mode lock.....	60
11.4.1	To turn ON heat mode lock.....	60

11.1 About standby electricity saving function



INFORMATION

This function is available only for the indoor units listed below.

The standby electricity saving function:

- turns OFF the power supply to the outdoor unit and,
- turns ON the standby electricity saving mode on the indoor unit.

The standby electricity saving function works with following units:



FTXM, FTXJ, FVXM, FTXA, CTXA, CTXM, CVXM, EKHWT, FTXP, CKHWS

If another indoor unit is used, the connector for standby electric saving MUST be plugged in.

The standby electricity saving function is turned OFF before shipping.

11.1.1 To turn ON standby electricity saving function

Prerequisite: The main power supply MUST be turned OFF.

- 1 Remove the service cover.
- 2 Disconnect the selective standby electricity saving connector.

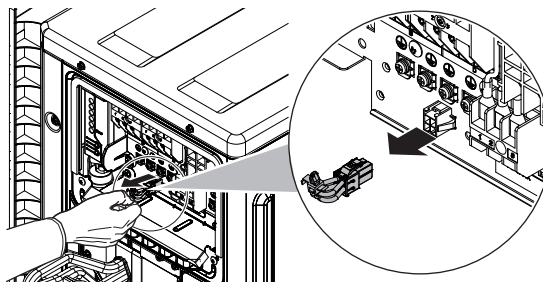

- 3 Turn ON the main power supply.

11.2 About priority room function



INFORMATION

- The priority room function requires initial settings to be made during the installation of the unit. Ask the customer in which rooms he plans to use this function and make the necessary settings during installation.
- The priority room setting is only applicable for an air conditioner indoor unit and only one room can be set.

The indoor unit for which the priority room setting is applied takes priority in the following cases:

- **Operation mode priority:** If the priority room function is set on an indoor unit, all other indoor units enter the standby mode.
- **Priority during high-power operation:** If the indoor unit on which the priority room function is set operates at high power, the other indoor units will run with reduced capabilities.
- **Quiet operation priority:** If the indoor unit on which the priority room function is set to quiet operation, the outdoor unit will also run quietly.

Ask the customer in which rooms he plans to use this function and make the necessary settings during installation. Setting it in the guest rooms is convenient.

11.2.1 To set the priority room function

- 1 Remove the switch cover on the service PCB.
- 2 Set the switch (SW4) for the indoor unit for which you want to activate the priority room function to ON.

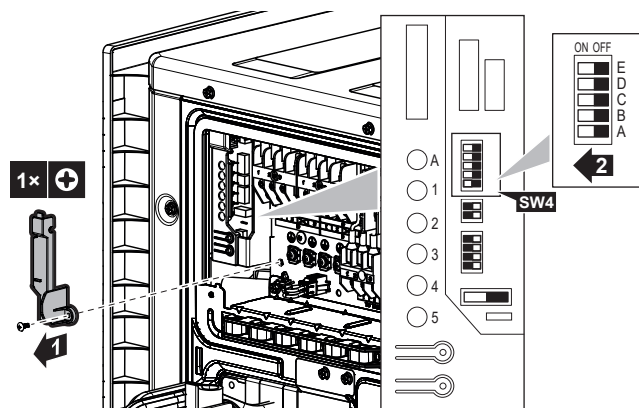

- 3 Reset the power.

11.3 About night quiet mode

The night quiet mode function makes the outdoor unit run more quietly at nighttime. This will reduce the cooling capacity of the unit. Explain Night quiet mode to the customer and confirm if customer wants to use this mode.

11.3.1 To turn ON the night quiet mode

- 1 Remove the switch cover on the service PCB.

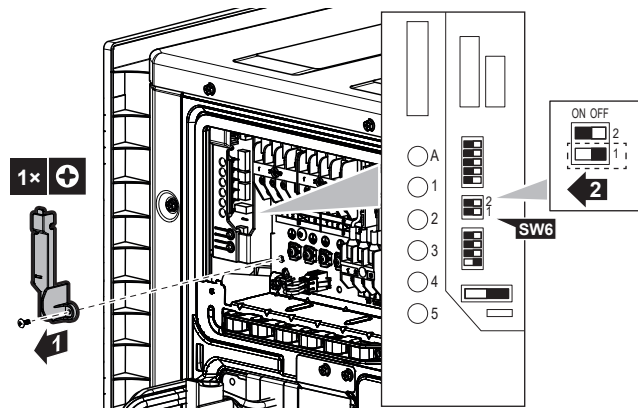

- 2 Set the night quiet mode switch (SW6-1) to ON.

11.4 About heat mode lock

Heat mode lock limits the unit to heat operation.

11.4.1 To turn ON heat mode lock

- 1 Remove the switch cover on the service PCB.
- 2 Set the heat mode lock switch (SW5-1) to ON.

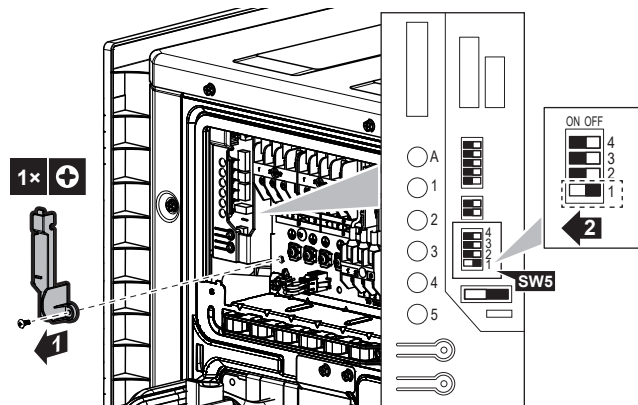

12 Commissioning



NOTICE

General commissioning checklist. Next to the commissioning instructions in this chapter, a general commissioning checklist is also available on the Daikin Business Portal (authentication required).

The general commissioning checklist is complementary to the instructions in this chapter and can be used as a guideline and reporting template during commissioning and hand-over to the user.



INFORMATION

In the case of an outdoor unit and tank-only connection, the backup heater may be used instead of the heat pump during cold outdoor conditions. This can occur within the first 7 hours after the power supply is turned on to ensure reliable compressor operation.

In this chapter

12.1	Overview: Commissioning	61
12.2	Precautions when commissioning.....	61
12.3	Checklist before commissioning.....	62
12.4	Checklist during commissioning.....	62
12.5	Trial operation and testing	63
12.5.1	About wiring error check	63
12.5.2	To perform a test run.....	64
12.6	Starting up the outdoor unit	65

12.1 Overview: Commissioning

This chapter describes what you have to do and know to commission the system after it is installed.

Typical workflow

Commissioning typically consists of the following stages:

- 1 Checking the "Checklist before commissioning".
- 2 Performing a test run for the system.

12.2 Precautions when commissioning



NOTICE

ALWAYS operate the unit with thermistors and/or pressure sensors/switches. If NOT, burning of the compressor might be the result.



NOTICE

ALWAYS complete the refrigerant piping of the unit before operating. If NOT, the compressor will break.



INFORMATION

During the first running period of the unit, the required power may be higher than stated on the nameplate of the unit. This phenomenon is caused by the compressor, that needs a continuous run time of 50 hours before reaching smooth operation and stable power consumption.

**INFORMATION**

In the case of an outdoor unit and tank-only connection, the backup heater may be used instead of the heat pump during cold outdoor conditions. This can occur within the first 7 hours after the power supply is turned on to ensure reliable compressor operation.

12.3 Checklist before commissioning

- 1 After the installation of the unit, check the items listed below.
- 2 Close the unit.
- 3 Power up the unit.

<input type="checkbox"/>	The indoor unit is properly mounted.
<input type="checkbox"/>	The outdoor unit is properly mounted.
<input type="checkbox"/>	The system is properly earthed and the earth terminals are tightened.
<input type="checkbox"/>	The power supply voltage matches the voltage on the identification label of the unit.
<input type="checkbox"/>	There are NO loose connections or damaged electrical components in the switch box.
<input type="checkbox"/>	There are NO damaged components or squeezed pipes on the inside of the indoor and outdoor units.
<input type="checkbox"/>	There are NO refrigerant leaks .
<input type="checkbox"/>	The refrigerant pipes (gas and liquid) are thermally insulated.
<input type="checkbox"/>	The correct pipe size is installed and the pipes are properly insulated.
<input type="checkbox"/>	The stop valves (gas and liquid) on the outdoor unit are fully open.
<input type="checkbox"/>	Drainage Make sure drainage flows smoothly. Possible consequence: Condensate water might drip.
<input type="checkbox"/>	The indoor unit receives the signals of the user interface .
<input type="checkbox"/>	The specified wires are used for the interconnection cable .
<input type="checkbox"/>	The fuses, circuit breakers , or locally installed protection devices are installed according to this document, and have NOT been bypassed.
<input type="checkbox"/>	Check if marks (room A~D and TO TANK) on the wiring and piping match for each connected unit.
<input type="checkbox"/>	Check if the priority room setting is NOT set for 2 or more rooms. Keep in mind that the DHW tank for Multi shall NOT be selected as the priority room.

12.4 Checklist during commissioning

<input type="checkbox"/>	To perform a wiring check.
<input type="checkbox"/>	To perform an air purge .
<input type="checkbox"/>	To perform a test run .

12.5 Trial operation and testing

<input type="checkbox"/>	Before starting the test run, measure the voltage at the primary side of the safety breaker .
<input type="checkbox"/>	The pipng and wiring work match.
<input type="checkbox"/>	The stop valves (gas and liquid) on the outdoor unit are fully open.

Initialization of the Multi system can take several minutes depending on the number of indoor units and options used.

12.5.1 About wiring error check



INFORMATION

This function is available only for the air-conditioning indoor units. DHW tank wiring **MUST** be check manually, automatic correction is **NOT** possible.

The wiring error check function will check and automatically correct any wiring errors. This is useful for checking wiring that **CANNOT** be checked directly, such as underground wiring.

This function **CANNOT** be used within 3 minutes after activating the safety breaker or when the outside air temperature is $\leq 10^{\circ}\text{C}$ and if water temperature in DHW tank is $\geq 20^{\circ}\text{C}$.

To perform a wiring error check



INFORMATION

You only have to perform a wiring error check if you are not sure that the electrical wiring and piping is connected correctly.

- 1 Remove the service PCB switch cover.

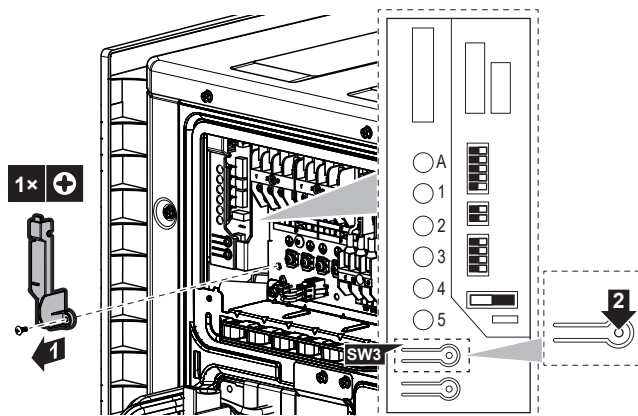

- 2 Press shortly the wiring error check switch (SW3) on the outdoor unit service PCB.

Result: The service monitor LEDs indicate whether correction is possible or not. For details about how to read the LED display, refer to the service manual.

Result: Wiring errors will be corrected after 15-20 minutes. If automatic correction is not possible, check the indoor unit wiring and piping in the usual way.

**INFORMATION**

- The number of LEDs displayed depends on the number of rooms.
- The wiring error check function will NOT work if outside temperature is $\leq 5^{\circ}\text{C}$ and if water temperature in DHW tank is $\geq 20^{\circ}\text{C}$.
- After wiring error check operation is completed, LED indication will continue until normal operation starts.
- Follow the product diagnosis procedures. For details of product error diagnosis refer to service manual.

Status of LEDs:

- All LEDs flash: automatic correction is NOT possible.
- LEDs flash alternately: automatic correction is completed.
- One or more LEDs are permanently on: abnormal stop (follow the diagnosis procedure on the back of the right side plate and refer to service manual).

12.5.2 To perform a test run

**INFORMATION**

For DHW tank test run procedure, refer to installation manual of DHW tank unit.

**INFORMATION**

If the unit runs into an error during commissioning, see the service manual for the detailed troubleshooting guidelines.

Prerequisite: Power supply MUST be in the specified range.

Prerequisite: Test run operation may be done in cooling or heating mode.

Prerequisite: Test run should be done in accordance with the operation manual of the indoor unit to make sure that all functions and parts are working properly.

- 1 In cooling mode, select the lowest programmable temperature. In heating mode, select the highest programmable temperature.
- 2 Measure the temperature at the indoor unit inlet and outlet after running the unit for about 20 minutes. The difference should be more than 8°C (cooling) or 20°C (heating).
- 3 First check operation of each unit individually, then check simultaneous operation of all indoor units. Check both heating and cooling operation.
- 4 When test run is finished, set the temperature to a normal level. In cooling mode: $26\sim 28^{\circ}\text{C}$, in heating mode: $20\sim 24^{\circ}\text{C}$.

**INFORMATION**

- Test run can be disabled if necessary.
- After the unit is turned OFF, it cannot be started again for 3 minutes.
- When the test run is started in the heat mode right after turning the safety breaker on, in some cases no air will be output for about 15 minutes in order to protect the unit.
- During cooling operation, frost may form on the gas stop valve or other parts. This is normal.

**INFORMATION**

- Even if the unit is turned OFF, it consumes electricity.
- When the power turns back on after a power break, the previously selected mode will be resumed.

12.6 Starting up the outdoor unit

See the indoor unit installation manual for configuration and commissioning of the system.

13 Hand-over to the user

Once the test run is finished and the unit operates properly, make sure the following is clear for the user:

- Make sure that the user has the printed documentation and ask him/her to keep it for future reference. Inform the user that he/she can find the complete documentation at the URL mentioned earlier in this manual.
- Explain to the user how to properly operate the system and what to do in case of problems.
- Show the user what to do for the maintenance of the unit.
- Explain about energy saving tips to the user as described in the user reference guide.

14 Maintenance and service



NOTICE

General maintenance/inspection checklist. Next to the maintenance instructions in this chapter, a general maintenance/inspection checklist is also available on the Daikin Business Portal (authentication required).

The general maintenance/inspection checklist is complementary to the instructions in this chapter and can be used as a guideline and reporting template during maintenance.



NOTICE

Maintenance **MUST** be done by an authorised installer or service agent.

We recommend performing maintenance at least once a year. However, applicable legislation might require shorter maintenance intervals.



NOTICE

Applicable legislation on **fluorinated greenhouse gases** requires that the refrigerant charge of the unit is indicated both in weight and CO₂ equivalent.

Formula to calculate the quantity in CO₂ equivalent tonnes: GWP value of the refrigerant × total refrigerant charge [in kg] / 1000



DANGER: RISK OF ELECTROCUTION

Disconnect the power supply for more than 10 minutes, and measure the voltage at the terminals of main circuit capacitors or electrical components before servicing. The voltage **MUST** be less than 50 V DC before you can touch electrical components. For the location of the terminals, see the wiring diagram.

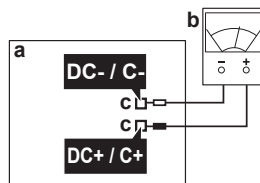

- a Main printed circuit board
- b Multimeter
- c Residual voltage measuring points

14.1 Overview: Maintenance and service

This chapter contains information about:

- Maintenance safety precautions
- The yearly maintenance of the outdoor unit

14.2 Maintenance safety precautions



DANGER: RISK OF ELECTROCUTION



DANGER: RISK OF BURNING/SCALDING

**WARNING**

- Before carrying out any maintenance or repair activity, ALWAYS switch off the circuit breaker on the supply panel, remove the fuses or open the protection devices of the unit.
- Do NOT touch live parts for 10 minutes after the power supply is turned off because of high voltage risk.
- Please note that some sections of the electric component box are hot.
- Make sure you do NOT touch a conductive section.
- Do NOT rinse the unit. This may cause electric shocks or fire.

**NOTICE: Risk of electrostatic discharge**

Before performing any maintenance or service work, touch a metal part of the unit in order to eliminate static electricity and to protect the PCB.

14.3 Checklist for yearly maintenance of the outdoor unit

Check the following at least once a year:

- Heat exchanger

The heat exchanger of the outdoor unit can get blocked up due to dust, dirt, leaves, etc. It is recommended to clean the heat exchanger yearly. A blocked heat exchanger can lead to too low pressure or too high pressure leading to worse performance.

14.4 About the compressor

When servicing the compressor keep in mind following precautions:

**DANGER: RISK OF ELECTROCUTION**

- Use this compressor on a grounded system only.
- Turn the power off before servicing the compressor.
- Reattach the switch box cover and service lid after servicing.

**CAUTION**

ALWAYS wear safety glasses and protective gloves.

**DANGER: RISK OF EXPLOSION**

- Use a pipe cutter to remove the compressor.
- Do NOT use the brazing torch.
- Use approved refrigerants and lubricants only.

**DANGER: RISK OF BURNING/SCALDING**

Do NOT touch the compressor with bare hands.

15 Troubleshooting

15.1 Overview: Troubleshooting

This chapter describes what you have to do in case of problems.

It contains information about:

- solving problems based on symptoms
- solving problems based on LED behaviour

Before troubleshooting

Carry out a thorough visual inspection of the unit and look for obvious defects such as loose connections or defective wiring.

15.2 Precautions when troubleshooting



DANGER: RISK OF ELECTROCUTION



DANGER: RISK OF BURNING/SCALDING



WARNING

- When carrying out an inspection on the switch box of the unit, ALWAYS make sure that the unit is disconnected from the mains. Turn off the respective circuit breaker.
- When a safety device was activated, stop the unit and find out why the safety device was activated before resetting it. NEVER shunt safety devices or change their values to a value other than the factory default setting. If you are unable to find the cause of the problem, call your dealer.



WARNING

Prevent hazards due to inadvertent resetting of the thermal cut-out: power to this appliance MUST NOT be supplied through an external switching device, such as a timer, or connected to a circuit that is regularly turned ON and OFF by the utility.

15.3 Solving problems based on symptoms

15.3.1 Symptom: Indoor units fall, vibrate or make noise

Possible causes	Corrective action
The indoor units are NOT installed securely.	Install the indoor units securely.

15.3.2 Symptom: The unit is NOT heating or cooling as expected

Possible causes	Corrective action
Wrong connection of the electrical wires.	Connect the electrical wires correctly.

Possible causes	Corrective action
Gas leakage.	Check for gas leakage.
Marks on the wiring and piping do NOT match.	Marks on the wiring and piping (room A, room B, room C, room D, TO TANK) for each indoor unit MUST match.

15.3.3 Symptom: Water leakage

Possible causes	Corrective action
Incomplete thermal insulation (gas and liquid piping, indoor portions of the drain hose extension).	Make sure the thermal insulation of the piping and the drain hose is complete.
Improperly connected drainage.	Secure the drainage.

15.3.4 Symptom: Electrical leakage

Possible causes	Corrective action
The unit is NOT earthed correctly.	Check and correct the connection of the earth wiring.

15.3.5 Symptom: Priority room setting does NOT function

Possible causes	Corrective action
The priority room setting may be set for more than 1 room.	Only 1 room may be selected for the priority room setting.
A DHW tank for Multi CANNOT be selected as priority room.	Please select an airconditioning unit as priority room.

15.3.6 Symptom: Unit does NOT function or burn damage

Possible causes	Corrective action
The wiring was NOT performed in accordance with the specifications.	Correct the wiring.

15.4 Solving problems based on LED behaviour

15.4.1 Fault diagnosis using LED on outdoor unit PCB



DANGER: RISK OF ELECTROCUTION

- When the unit is NOT operating, the LEDs on the PCB are turned OFF in order to save power.
- Even when the LEDs are OFF, the terminal block and the PCB may be powered.

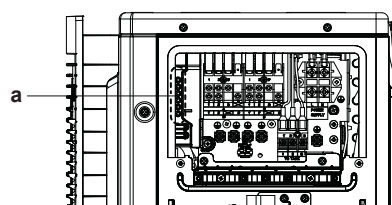

a Location of LED

Symbol		LED is...				
		ON				
		OFF				
		Flashing				
Red LED ^(a)					Diagnosis	
1	2	3	4	5		
					Normal. ▪ Check the indoor unit.	
					High-pressure protector worked or freeze-up in operating unit, or stand-by unit.	
					Overload relay worked or high discharge pipe temperature. ^(b)	
					Faulty compressor start.	
					Input over-current.	
					Thermistor or CT abnormality. ^(b)	
					High temperature switch box.	
					High temperature at inverter circuit heat sink.	
					Output over-current. ^(b)	
					Refrigerant shortage. ^(b)	
					Low voltage to main circuit or over voltage to main circuit.	
					Reversing solenoid valve switching failure or high-pressure switching failure. ^(b)	
					Faulty outdoor unit PCB.	
					Fan motor fault.	
					Wiring error ▪ Check wiring.	
Green LED-A					Diagnosis	
					Normal. ▪ Check the indoor unit.	
					Turn the power OFF and back ON, and check the LED within approximately 3 minutes. If the LED is ON again, the outdoor unit PCB is faulty.	
					Power supply fault. ^(b)	

^(a) The number of LEDs displayed depends on the number of rooms.

^(b) Diagnosis may not apply to some cases. For more details, refer to the service manual.

16 Disposal



NOTICE

Do NOT try to dismantle the system yourself: dismantling of the system, treatment of the refrigerant, oil and other parts MUST comply with applicable legislation. Units MUST be treated at a specialised treatment facility for reuse, recycling and recovery.

16.1 Overview: Disposal

Typical workflow

Disposing of the system typically consists of the following stages:

- 1 Pumping down the system.
- 2 Bringing the system to a specialized treatment facility.



INFORMATION

For more details, see the service manual.

16.2 To pump down

Example: To protect the environment, pump down when relocating the unit or when disposing of the unit.



DANGER: RISK OF EXPLOSION

Pump down – Refrigerant leakage. If you want to pump down the system, and there is a leak in the refrigerant circuit:

- Do NOT use the unit's automatic pump down function, with which you can collect all refrigerant from the system into the outdoor unit. **Possible consequence:** Self-combustion and explosion of the compressor because of air going into the operating compressor.
- Use a separate recovery system so that the unit's compressor does NOT have to operate.



NOTICE

During pump down operation, stop the compressor before removing the refrigerant piping. If the compressor is still running and the stop valve is open during pump down, air will be sucked into the system. Compressor breakdown or damage to the system can result due to abnormal pressure in the refrigerant cycle.

Pump down operation will extract all refrigerant from the system into the outdoor unit.

- 1 Remove the valve cap from the both liquid stop valves and the both gas stop valves.
- 2 Carry out forced cooling. See "[16.3 To start and stop forced cooling](#)" [▶ 73].
- 3 Close the both liquid stop valves with a hexagonal wrench.
 - After 5 to 10 minutes
 - After only 1 or 2 minutes in case of very low ambient temperatures (<-10°C)
 - After only 0.5 minutes in case of connection to CKHWS only
- 4 Check on the manifold if the vacuum is reached.

- 5 After 2-3 minutes, close the both gas stop valves and stop forced cooling.

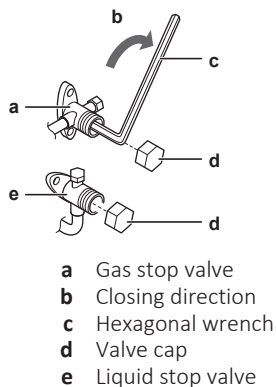

16.3 To start and stop forced cooling

- 1 Turn OFF the power, remove the service cover and the switch box cover and the service PCB switch cover.
- 2 Set DIP switch SW5 and SW6 to OFF.
- 3 Set DIP switch SW2 to COOL.

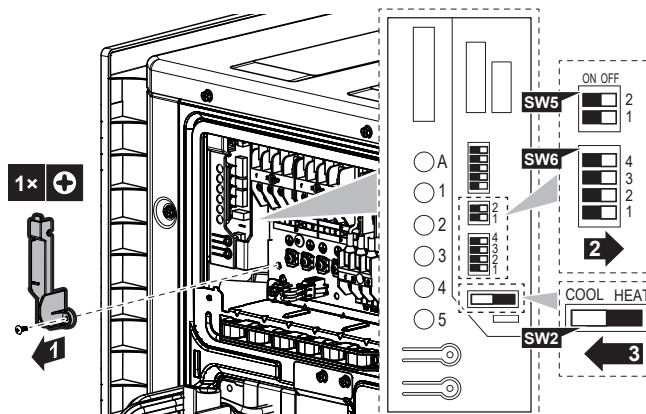

- 4 Reattach the service PCB switch cover.
- 5 Turn ON the outdoor unit.
- 6 Press the forced cooling operation switch SW1 to begin forced cooling.
- 7 Press the forced cooling operation switch SW1 to stop forced cooling.

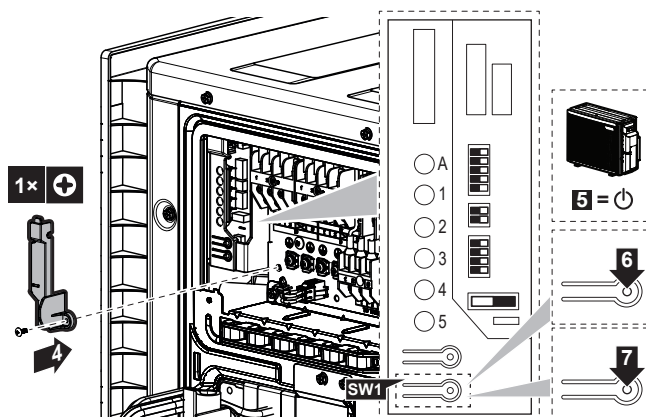

- 8 Close switch box cover and service cover.



NOTICE

Take care that while running forced cooling operation, the water temperature remains higher than 5°C (see temperature read out of the indoor unit). You can achieve this, for example, by activating all fans of the fan coil units.

17 Technical data



















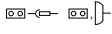

- A **subset** of the latest technical data is available on the regional Daikin website (publicly accessible).
- The **full set** of the latest technical data is available on the Daikin Business Portal (authentication required).

17.1 Wiring diagram

The wiring diagram is delivered with the unit, located inside of the outdoor unit (bottom side of the top plate).

17.1.1 Unified wiring diagram legend

For applied parts and numbering, refer to the wiring diagram on the unit. Part numbering is by Arabic numbers in ascending order for each part and is represented in the overview below by "*" in the part code.

Symbol	Meaning	Symbol	Meaning
	Circuit breaker		Protective earth
			Noiseless earth
			Protective earth (screw)
	Connection		Rectifier
	Connector		Relay connector
	Earth		Short-circuit connector
	Field wiring		Terminal
	Fuse		Terminal strip
	Indoor unit		Wire clamp
	Outdoor unit		Heater
	Residual current device		

Symbol	Colour	Symbol	Colour
BLK	Black	ORG	Orange
BLU	Blue	PNK	Pink
BRN	Brown	PRP, PPL	Purple
GRN	Green	RED	Red
GRY	Grey	WHT	White
SKY BLU	Sky blue	YLW	Yellow

Symbol	Meaning
A*P	Printed circuit board
BS*	Pushbutton ON/OFF, operation switch
BZ, H*O	Buzzer

Symbol	Meaning
C*	Capacitor
AC*, CN*, E*, HA*, HE*, HL*, HN*, HR*, MR*_A, MR*_B, S*, U, V, W, X*A, K*R_*, NE	Connection, connector
D*, V*D	Diode
DB*	Diode bridge
DS*	DIP switch
E*H	Heater
FU*, F*U, (for characteristics, refer to PCB inside your unit)	Fuse
FG*	Connector (frame ground)
H*	Harness
H*P, LED*, V*L	Pilot lamp, light emitting diode
HAP	Light emitting diode (service monitor green)
HIGH VOLTAGE	High voltage
IES	Intelligent eye sensor
IPM*	Intelligent power module
K*R, KCR, KFR, KHuR, K*M	Magnetic relay
L	Live
L*	Coil
L*R	Reactor
M*	Stepper motor
M*C	Compressor motor
M*F	Fan motor
M*P	Drain pump motor
M*S	Swing motor
MR*, MRCW*, MRM*, MRN*	Magnetic relay
N	Neutral
n=*, N=*	Number of passes through ferrite core
PAM	Pulse-amplitude modulation
PCB*	Printed circuit board
PM*	Power module
PS	Switching power supply
PTC*	PTC thermistor
Q*	Insulated gate bipolar transistor (IGBT)
Q*C	Circuit breaker
Q*DI, KLM	Earth leak circuit breaker

Symbol	Meaning
Q*L	Overload protector
Q*M	Thermo switch
Q*R	Residual current device
R*	Resistor
R*T	Thermistor
RC	Receiver
S*C	Limit switch
S*L	Float switch
S*NG	Refrigerant leak detector
S*NPH	Pressure sensor (high)
S*NPL	Pressure sensor (low)
S*PH, HPS*	Pressure switch (high)
S*PL	Pressure switch (low)
S*T	Thermostat
S*RH	Humidity sensor
S*W, SW*	Operation switch
SA*, F1S	Surge arrester
SR*, WLU	Signal receiver
SS*	Selector switch
SHEET METAL	Terminal strip fixed plate
T*R	Transformer
TC, TRC	Transmitter
V*, R*V	Varistor
V*R	Diode bridge, Insulated-gate bipolar transistor (IGBT) power module
WRC	Wireless remote controller
X*	Terminal
X*M	Terminal strip (block)
Y*E	Electronic expansion valve coil
Y*R, Y*S	Reversing solenoid valve coil
Z*C	Ferrite core
ZF, Z*F	Noise filter

17.2 Piping diagram: Outdoor unit

Component PED category classification:

- High pressure switches: category IV
- Compressor: category II

- Accumulator: category II
- Other components: refer to PED article 4, paragraph 3

5MWXM68

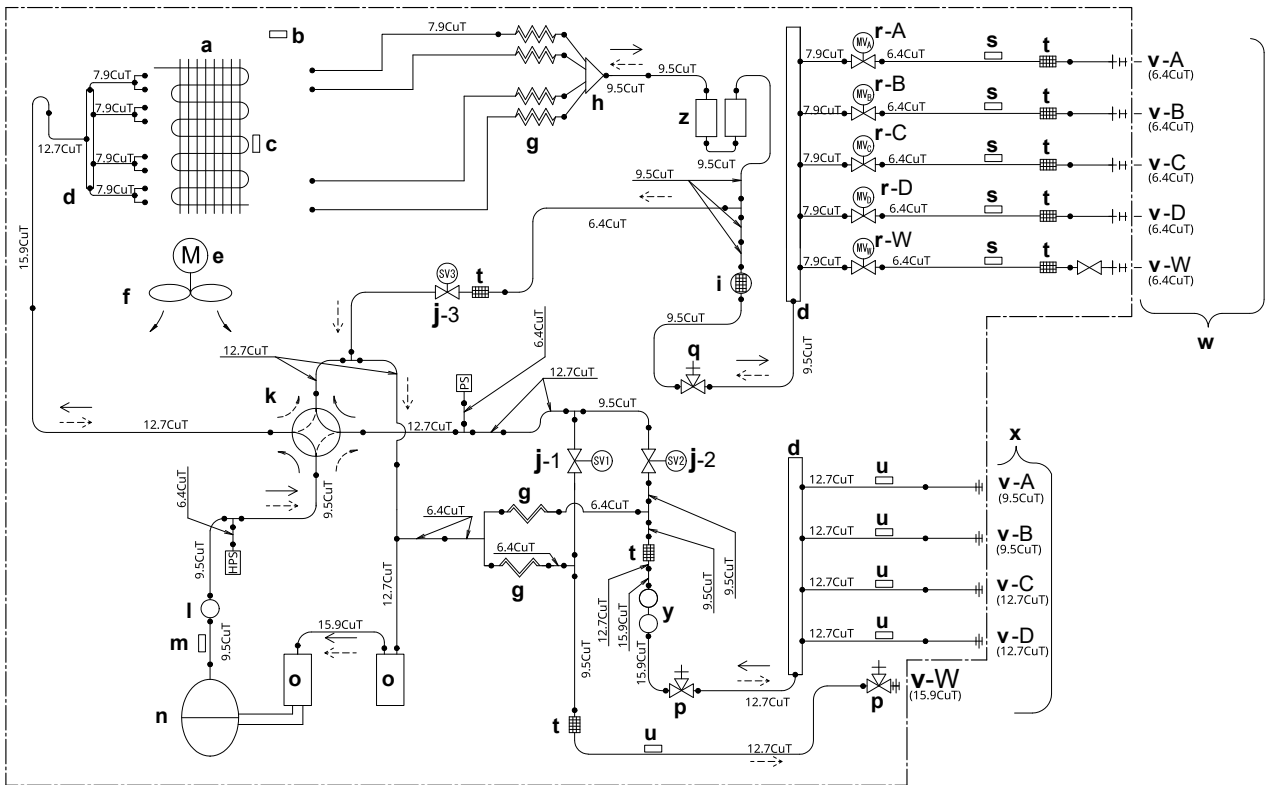

5MWXM90

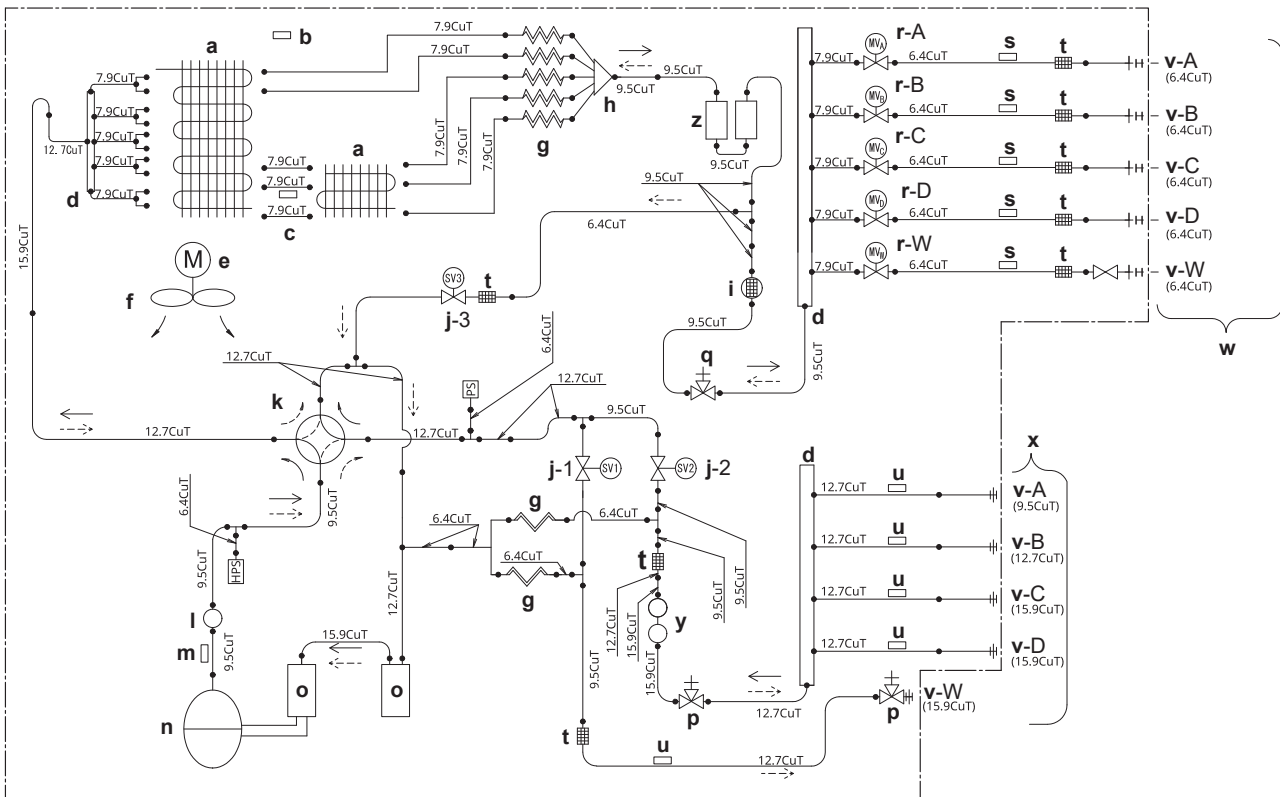

- | | | |
|---|------------------------------------|--|
| a Heat exchanger | k 4-way valve | u Thermistor (gas) |
| b Outdoor air temperature thermistor | l Muffler | v Room (A, B, C, D) and Domestic hot water tank (W) |
| c Heat exchanger thermistor | m Discharge pipe thermistor | w Field piping – liquid |

d	Refnet header	n	Compressor	x	Field piping – gas
e	Fan motor	o	Accumulator	y	Twin-branched muffler
f	Propeller fan	p	Gas stop valve	z	Liquid reciver
g	Capillary tube	q	Liquid stop valve	PS	Pressure sensor
h	Distributor	r	Electronic expansion valve	HPS	High pressure switch (automatic reset)
i	Muffler with filter	s	Thermistor (liquid)	—→	Refrigerant flow: cooling
j	Solenoid valve	t	Filter	---→	Refrigerant flow: DX heating / DHW

18 Glossary

Dealer

Sales distributor for the product.

Authorised installer

Technical skilled person who is qualified to install the product.

User

Person who is owner of the product and/or operates the product.

Applicable legislation

All international, European, national and local directives, laws, regulations and/or codes that are relevant and applicable for a certain product or domain.

Service company

Qualified company which can perform or coordinate the required service to the product.

Installation manual

Instruction manual specified for a certain product or application, explaining how to install, configure and maintain it.

Operation manual

Instruction manual specified for a certain product or application, explaining how to operate it.

Maintenance instructions

Instruction manual specified for a certain product or application, which explains (if relevant) how to install, configure, operate and/or maintain the product or application.

Accessories

Labels, manuals, information sheets and equipment that are delivered with the product and that need to be installed according to the instructions in the accompanying documentation.

Optional equipment

Equipment made or approved by Daikin that can be combined with the product according to the instructions in the accompanying documentation.

Field supply

Equipment NOT made by Daikin that can be combined with the product according to the instructions in the accompanying documentation.







DAIKIN INDUSTRIES CZECH REPUBLIC s.r.o.

U Nové Hospody 1155/1, 301 00 Plzeň Skvrňany, Czech Republic

DAIKIN EUROPE N.V.

Zandvoordestraat 300, B-8400 Oostende, Belgium

Copyright 2024 Daikin

4P766272-3D 2025.08