

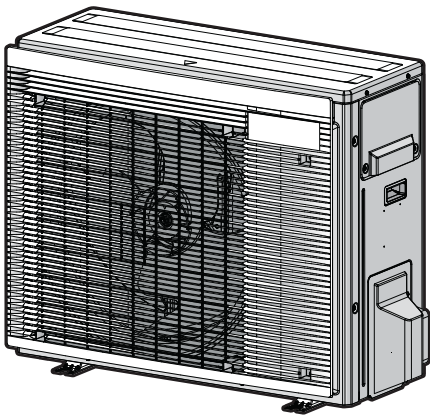

# Installation manual



## R32 split series



RXJ42A5V1B9  
RXJ50A5V1B9

Installation manual  
R32 split series

English



- EU - Safety declaration of conformity  
EU - Szabványos Konformitási Nyilatkozás  
UE - Déclaration de conformité de sécurité  
EU - Conformitatserklaring van veiligheid
- 01 (C) continuation of previous page  
02 (C) Fortsetzung der vorherigen Seite:  
03 (C) sulla página precedente:  
04 (C) vervolg van vorige pagina:

- UE - Declaration of conformity and safety  
UE - Dichiarazione di conformità in materia di sicurezza  
EU - Sikkerheds- og sikkerhedsoplysninger  
EU - Konformitatsdeklaration för säkerhet
- 05 (C) continuación de la página anterior:  
06 (C) continua della pagina precedente:  
07 (C) folytatás az előző oldalról:  
08 (C) voortzet van vorige pagina:

- 01 - Maximum allowable pressure (PS): <F> (bar)  
- Maximum allowable temperature (TS):  
\* TSmin: Minimum temperature at low pressure side: <F> (°C)  
\* TSmax: Maximum temperature corresponding with the maximum allowable pressure (PS): <F> (°C)  
- Refrigerant: <F>  
- Setting of pressure safety device: <F> (bar)  
- Manufacturing number and manufacturing year: refer to model nameplate
- 02 - Maximal zulässiger Druck (PS): <F> (bar)  
- Maximal zulässige Temperatur (TS):  
\* TSmin: Mindesttemperatur auf der Niederdruckseite: <F> (°C)  
\* TSmax: Stütztemperatur bei dem maximal zulässigen Druck (PS) entspricht: <F> (°C)  
- Kältemittel: <F>  
- Einstellung der Druck-Sicherheitsvorrichtung: <F> (bar)  
- Hersteller- und Herstellungsjahr: siehe Typenschild des Modells
- 03 - Pression maximale admissible (PS): <F> (bar)  
- Température minimum/admissible admissible (TS):  
\* TSmin: température minimum côté basse pression: <F> (°C)  
\* TSmax: température supportée correspondant à la pression maximale admissible (PS): <F> (°C)  
- Réfrigérant: <F>  
- Réglage du dispositif de sécurité de pression: <F> (bar)  
- Numéro de fabrication et année de fabrication: se reporter à la plaquette signalétique du modèle
- 04 - Maximálny povolený tlak (PS): <F> (bar)  
- Maximálny povolená teplota (TS):  
\* TSmin: Minimálna teplota pri nízkej úrovni tlaku: <F> (°C)  
\* TSmax: Teplota pri maximálnom povolenom tlaku (PS): <F> (°C)  
- Chladivo: <F>

- 05 - Fabrikcenummer en fabricatiejaar: zie naamplaat model  
- Pression maxima admissible (PS): <F> (bar)  
- Température minimum/admissible admissible (TS):  
\* TSmin: Température minimum au côté basse pression: <F> (°C)  
\* TSmax: Température admissible correspondant à la pression maximale admissible (PS): <F> (°C)  
- Réfrigérant: <F>  
- Numéro de fabrication et année de fabrication: consultez la plaque de spécifications techniques du modèle
- 06 - Fabrikcenummer en fabricatiejaar: zie naamplaat model  
- Pression maxima admissible (PS): <F> (bar)  
- Température minimum/admissible admissible (TS):  
\* TSmin: Température minimum au côté basse pression: <F> (°C)  
\* TSmax: Température admissible correspondant à la pression maximale admissible (PS): <F> (°C)  
- Réfrigérant: <F>  
- Numéro de fabrication et année de fabrication: consultez la plaque de spécifications techniques du modèle

- 07 - Name and address of the Notified body that judged positively on compliance with the Pressure Equipment Directive: <F>  
Duck anlagen-Rechtliche Einheit: <F>  
08 - Nome e morada do organismo notificado, que avaliou favoravelmente a conformidade com a diretiva sobre equipamentos pressurizados: <F>  
Hozsém és címe az engedélyező szervnek, amely a felszerelés megfelelőségét megerősítette az Európai Unió Irányelvéről szóló jogszabály alapján: <F>  
09 - Nombre et adresse de l'organisme notifié qui a évalué positivement la conformité avec la directive sur l'équipement à pression: <F>  
Název a adresa van van aangewezen instantie die positief geardeed heeft over de conformiteit met de Richtlijn Drukapparatuur: <F>  
09 - Nome e indirizzo dell'Ente riconosciuto che ha riscontrato la conformità alla Direttiva sulle apparecchiature a pressione: <F>

- 01 - Name and address of the Notified body that judged positively on compliance with the Pressure Equipment Directive: <F>  
02 - Name and address of the Notified Body, which positively assessed conformity with the Pressure Equipment Directive: <F>  
03 - Name and address of the Notified Body, which positively assessed conformity with the Pressure Equipment Directive: <F>  
04 - Name and address of the Notified Body, which positively assessed conformity with the Pressure Equipment Directive: <F>  
05 - Name and address of the Notified Body, which positively assessed conformity with the Pressure Equipment Directive: <F>  
06 - Name and address of the Notified Body, which positively assessed conformity with the Pressure Equipment Directive: <F>

- 07 - Όνομα και διεύθυνση του Κλιμακωπέντη οργανισμού που απευθύνθηκε θετικά για τη συμμόρφωση προς την Οδηγία Εργαλείων υπό Πίεση: <F>  
08 - Nome e morada do organismo notificado, que avaliou favoravelmente a conformidade com a diretiva sobre equipamentos pressurizados: <F>  
09 - Hozsém és címe az engedélyező szervnek, amely a felszerelés megfelelőségét megerősítette az Európai Unió Irányelvéről szóló jogszabály alapján: <F>  
10 - Nombre et adresse de l'organisme notifié qui a évalué positivement la conformité avec la directive sur l'équipement à pression: <F>  
11 - Název a adresa van van aangewezen instantie die positief geardeed heeft over de conformiteit met de Richtlijn Drukapparatuur: <F>

- EC - Звернення о відповідності до вимог безпечності  
EU - Samsvareklaring for sikkerhed  
EU - Tuusallisuuden valtuustamarkkinatutkimus  
EU - Вроповідності пробишен о шуде
- 12 (C) Fortsette fra forrige side:  
13 (C) jatkoa edellisellä sivulla:  
14 (C) pokračování z předchozí strany:  
15 (C) voortzet van vorige pagina:

- EC - Звернення о відповідності до вимог безпечності  
EU - Samsvareklaring for sikkerhed  
EU - Tuusallisuuden valtuustamarkkinatutkimus  
EU - Вроповідності пробишен о шуде
- 12 (C) Fortsette fra forrige side:  
13 (C) jatkoa edellisellä sivulla:  
14 (C) pokračování z předchozí strany:  
15 (C) voortzet van vorige pagina:

- 13 - Таї ішолюса ковселен утвудлен намендіатїле: <F>  
14 - Specificație construcție produse, ce trebuie să cuprindă toate informațiile: <F>  
15 - Specificación de diseño de los productos a los cuales hace referencia esta declaración:  
16 - Produktspecificationer for de produkter som denne deklarasjon angår:  
17 - Produktspecificationer for de produkter som denne deklarasjon angår:  
18 - Produktspecificationer for de produkter som denne deklarasjon angår:  
19 - Produktspecificationer for de produkter som denne deklarasjon angår:
- 16 - Produktspecificationer for de produkter som denne deklarasjon angår:  
17 - Produktspecificationer for de produkter som denne deklarasjon angår:  
18 - Produktspecificationer for de produkter som denne deklarasjon angår:  
19 - Produktspecificationer for de produkter som denne deklarasjon angår:

- 16 - Produktspecificationer for de produkter som denne deklarasjon angår:  
17 - Produktspecificationer for de produkter som denne deklarasjon angår:  
18 - Produktspecificationer for de produkter som denne deklarasjon angår:  
19 - Produktspecificationer for de produkter som denne deklarasjon angår:
- 16 - Produktspecificationer for de produkter som denne deklarasjon angår:  
17 - Produktspecificationer for de produkter som denne deklarasjon angår:  
18 - Produktspecificationer for de produkter som denne deklarasjon angår:  
19 - Produktspecificationer for de produkter som denne deklarasjon angår:

- 16 - Produktspecificationer for de produkter som denne deklarasjon angår:  
17 - Produktspecificationer for de produkter som denne deklarasjon angår:  
18 - Produktspecificationer for de produkter som denne deklarasjon angår:  
19 - Produktspecificationer for de produkter som denne deklarasjon angår:
- 16 - Produktspecificationer for de produkter som denne deklarasjon angår:  
17 - Produktspecificationer for de produkter som denne deklarasjon angår:  
18 - Produktspecificationer for de produkter som denne deklarasjon angår:  
19 - Produktspecificationer for de produkter som denne deklarasjon angår:

- 16 - Produktspecificationer for de produkter som denne deklarasjon angår:  
17 - Produktspecificationer for de produkter som denne deklarasjon angår:  
18 - Produktspecificationer for de produkter som denne deklarasjon angår:  
19 - Produktspecificationer for de produkter som denne deklarasjon angår:
- 16 - Produktspecificationer for de produkter som denne deklarasjon angår:  
17 - Produktspecificationer for de produkter som denne deklarasjon angår:  
18 - Produktspecificationer for de produkter som denne deklarasjon angår:  
19 - Produktspecificationer for de produkter som denne deklarasjon angår:

- EU - Вроповідності пробишен о шуде  
EU - Declaration de conformité de sécurité  
EU - Conformitatserklaring van veiligheid
- 12 (C) Fortsette fra forrige side:  
13 (C) jatkoa edellisellä sivulla:  
14 (C) pokračování z předchozí strany:  
15 (C) voortzet van vorige pagina:

- 12 - Produktspecificationer for de produkter som denne deklarasjon angår:  
13 - Produktspecificationer for de produkter som denne deklarasjon angår:  
14 - Produktspecificationer for de produkter som denne deklarasjon angår:  
15 - Produktspecificationer for de produkter som denne deklarasjon angår:
- 12 - Produktspecificationer for de produkter som denne deklarasjon angår:  
13 - Produktspecificationer for de produkter som denne deklarasjon angår:  
14 - Produktspecificationer for de produkter som denne deklarasjon angår:  
15 - Produktspecificationer for de produkter som denne deklarasjon angår:

- 12 - Produktspecificationer for de produkter som denne deklarasjon angår:  
13 - Produktspecificationer for de produkter som denne deklarasjon angår:  
14 - Produktspecificationer for de produkter som denne deklarasjon angår:  
15 - Produktspecificationer for de produkter som denne deklarasjon angår:
- 12 - Produktspecificationer for de produkter som denne deklarasjon angår:  
13 - Produktspecificationer for de produkter som denne deklarasjon angår:  
14 - Produktspecificationer for de produkter som denne deklarasjon angår:  
15 - Produktspecificationer for de produkter som denne deklarasjon angår:

- 12 - Produktspecificationer for de produkter som denne deklarasjon angår:  
13 - Produktspecificationer for de produkter som denne deklarasjon angår:  
14 - Produktspecificationer for de produkter som denne deklarasjon angår:  
15 - Produktspecificationer for de produkter som denne deklarasjon angår:
- 12 - Produktspecificationer for de produkter som denne deklarasjon angår:  
13 - Produktspecificationer for de produkter som denne deklarasjon angår:  
14 - Produktspecificationer for de produkter som denne deklarasjon angår:  
15 - Produktspecificationer for de produkter som denne deklarasjon angår:

- 12 - Produktspecificationer for de produkter som denne deklarasjon angår:  
13 - Produktspecificationer for de produkter som denne deklarasjon angår:  
14 - Produktspecificationer for de produkter som denne deklarasjon angår:  
15 - Produktspecificationer for de produkter som denne deklarasjon angår:
- 12 - Produktspecificationer for de produkter som denne deklarasjon angår:  
13 - Produktspecificationer for de produkter som denne deklarasjon angår:  
14 - Produktspecificationer for de produkter som denne deklarasjon angår:  
15 - Produktspecificationer for de produkter som denne deklarasjon angår:

- 12 - Produktspecificationer for de produkter som denne deklarasjon angår:  
13 - Produktspecificationer for de produkter som denne deklarasjon angår:  
14 - Produktspecificationer for de produkter som denne deklarasjon angår:  
15 - Produktspecificationer for de produkter som denne deklarasjon angår:
- 12 - Produktspecificationer for de produkter som denne deklarasjon angår:  
13 - Produktspecificationer for de produkter som denne deklarasjon angår:  
14 - Produktspecificationer for de produkter som denne deklarasjon angår:  
15 - Produktspecificationer for de produkter som denne deklarasjon angår:

- EU - Вроповідності пробишен о шуде  
EU - Declaration de conformité de sécurité  
EU - Conformitatserklaring van veiligheid
- 12 (C) Fortsette fra forrige side:  
13 (C) jatkoa edellisellä sivulla:  
14 (C) pokračování z předchozí strany:  
15 (C) voortzet van vorige pagina:

- 12 - Produktspecificationer for de produkter som denne deklarasjon angår:  
13 - Produktspecificationer for de produkter som denne deklarasjon angår:  
14 - Produktspecificationer for de produkter som denne deklarasjon angår:  
15 - Produktspecificationer for de produkter som denne deklarasjon angår:
- 12 - Produktspecificationer for de produkter som denne deklarasjon angår:  
13 - Produktspecificationer for de produkter som denne deklarasjon angår:  
14 - Produktspecificationer for de produkter som denne deklarasjon angår:  
15 - Produktspecificationer for de produkter som denne deklarasjon angår:

- 12 - Produktspecificationer for de produkter som denne deklarasjon angår:  
13 - Produktspecificationer for de produkter som denne deklarasjon angår:  
14 - Produktspecificationer for de produkter som denne deklarasjon angår:  
15 - Produktspecificationer for de produkter som denne deklarasjon angår:
- 12 - Produktspecificationer for de produkter som denne deklarasjon angår:  
13 - Produktspecificationer for de produkter som denne deklarasjon angår:  
14 - Produktspecificationer for de produkter som denne deklarasjon angår:  
15 - Produktspecificationer for de produkter som denne deklarasjon angår:

- 12 - Produktspecificationer for de produkter som denne deklarasjon angår:  
13 - Produktspecificationer for de produkter som denne deklarasjon angår:  
14 - Produktspecificationer for de produkter som denne deklarasjon angår:  
15 - Produktspecificationer for de produkter som denne deklarasjon angår:
- 12 - Produktspecificationer for de produkter som denne deklarasjon angår:  
13 - Produktspecificationer for de produkter som denne deklarasjon angår:  
14 - Produktspecificationer for de produkter som denne deklarasjon angår:  
15 - Produktspecificationer for de produkter som denne deklarasjon angår:

- 12 - Produktspecificationer for de produkter som denne deklarasjon angår:  
13 - Produktspecificationer for de produkter som denne deklarasjon angår:  
14 - Produktspecificationer for de produkter som denne deklarasjon angår:  
15 - Produktspecificationer for de produkter som denne deklarasjon angår:
- 12 - Produktspecificationer for de produkter som denne deklarasjon angår:  
13 - Produktspecificationer for de produkter som denne deklarasjon angår:  
14 - Produktspecificationer for de produkter som denne deklarasjon angår:  
15 - Produktspecificationer for de produkter som denne deklarasjon angår:

- 12 - Produktspecificationer for de produkter som denne deklarasjon angår:  
13 - Produktspecificationer for de produkter som denne deklarasjon angår:  
14 - Produktspecificationer for de produkter som denne deklarasjon angår:  
15 - Produktspecificationer for de produkter som denne deklarasjon angår:
- 12 - Produktspecificationer for de produkter som denne deklarasjon angår:  
13 - Produktspecificationer for de produkter som denne deklarasjon angår:  
14 - Produktspecificationer for de produkter som denne deklarasjon angår:  
15 - Produktspecificationer for de produkter som denne deklarasjon angår:

- EC - Деларация за съответствие за безопасност  
ES - Dichiarazione di conformità in materia di sicurezza  
EU - Sikkerheds- og sikkerhedsoplysninger  
EU - Konformitatsdeklaration för säkerhet
- 12 (C) Fortsette fra forrige side:  
13 (C) jatkoa edellisellä sivulla:  
14 (C) pokračování z předchozí strany:  
15 (C) voortzet van vorige pagina:

- 12 - Produktspecificationer for de produkter som denne deklarasjon angår:  
13 - Produktspecificationer for de produkter som denne deklarasjon angår:  
14 - Produktspecificationer for de produkter som denne deklarasjon angår:  
15 - Produktspecificationer for de produkter som denne deklarasjon angår:
- 12 - Produktspecificationer for de produkter som denne deklarasjon angår:  
13 - Produktspecificationer for de produkter som denne deklarasjon angår:  
14 - Produktspecificationer for de produkter som denne deklarasjon angår:  
15 - Produktspecificationer for de produkter som denne deklarasjon angår:

- 12 - Produktspecificationer for de produkter som denne deklarasjon angår:  
13 - Produktspecificationer for de produkter som denne deklarasjon angår:  
14 - Produktspecificationer for de produkter som denne deklarasjon angår:  
15 - Produktspecificationer for de produkter som denne deklarasjon angår:
- 12 - Produktspecificationer for de produkter som denne deklarasjon angår:  
13 - Produktspecificationer for de produkter som denne deklarasjon angår:  
14 - Produktspecificationer for de produkter som denne deklarasjon angår:  
15 - Produktspecificationer for de produkter som denne deklarasjon angår:

- 12 - Produktspecificationer for de produkter som denne deklarasjon angår:  
13 - Produktspecificationer for de produkter som denne deklarasjon angår:  
14 - Produktspecificationer for de produkter som denne deklarasjon angår:  
15 - Produktspecificationer for de produkter som denne deklarasjon angår:
- 12 - Produktspecificationer for de produkter som denne deklarasjon angår:  
13 - Produktspecificationer for de produkter som denne deklarasjon angår:  
14 - Produktspecificationer for de produkter som denne deklarasjon angår:  
15 - Produktspecificationer for de produkter som denne deklarasjon angår:

- 12 - Produktspecificationer for de produkter som denne deklarasjon angår:  
13 - Produktspecificationer for de produkter som denne deklarasjon angår:  
14 - Produktspecificationer for de produkter som denne deklarasjon angår:  
15 - Produktspecificationer for de produkter som denne deklarasjon angår:
- 12 - Produktspecificationer for de produkter som denne deklarasjon angår:  
13 - Produktspecificationer for de produkter som denne deklarasjon angår:  
14 - Produktspecificationer for de produkter som denne deklarasjon angår:  
15 - Produktspecificationer for de produkter som denne deklarasjon angår:

- 12 - Produktspecificationer for de produkter som denne deklarasjon angår:  
13 - Produktspecificationer for de produkter som denne deklarasjon angår:  
14 - Produktspecificationer for de produkter som denne deklarasjon angår:  
15 - Produktspecificationer for de produkter som denne deklarasjon angår:
- 12 - Produktspecificationer for de produkter som denne deklarasjon angår:  
13 - Produktspecificationer for de produkter som denne deklarasjon angår:  
14 - Produktspecificationer for de produkter som denne deklarasjon angår:  
15 - Produktspecificationer for de produkter som denne deklarasjon angår:

## Table of Contents

<b>1</b>	<b>About the documentation</b>	<b>4</b>
1.1	About this document.....	4
<b>2</b>	<b>Specific installer safety instructions</b>	<b>5</b>
<b>3</b>	<b>About the box</b>	<b>6</b>
3.1	Outdoor unit.....	6
3.1.1	To remove the accessories from the outdoor unit.....	6
<b>4</b>	<b>Unit installation</b>	<b>7</b>
4.1	Preparing the installation site.....	7
4.1.1	Installation site requirements of the outdoor unit.....	7
4.1.2	Additional installation site requirements of the outdoor unit in cold climates.....	7
4.2	Mounting the outdoor unit.....	7
4.2.1	To provide the installation structure.....	7
4.2.2	To install the outdoor unit.....	8
4.2.3	To provide drainage.....	8
<b>5</b>	<b>Piping installation</b>	<b>8</b>
5.1	Preparing refrigerant piping.....	8
5.1.1	Refrigerant piping requirements.....	8
5.1.2	Refrigerant piping insulation.....	9
5.1.3	Refrigerant piping length and height difference.....	9
5.2	Connecting the refrigerant piping.....	9
5.2.1	To connect the refrigerant piping to the outdoor unit..	9
5.3	Checking the refrigerant piping.....	9
5.3.1	To check for leaks.....	9
5.3.2	To perform vacuum drying.....	10
<b>6</b>	<b>Charging refrigerant</b>	<b>10</b>
6.1	About the refrigerant.....	10
6.2	To determine the additional refrigerant amount.....	10
6.3	To determine the complete recharge amount.....	10
6.4	To charge additional refrigerant.....	10
6.5	To check refrigerant piping joints for leaks after charging refrigerant.....	10
6.6	To fix the fluorinated greenhouse gases label.....	11
<b>7</b>	<b>Electrical installation</b>	<b>11</b>
7.1	Specifications of standard wiring components.....	11
7.2	To connect the electrical wiring to the outdoor unit.....	11
<b>8</b>	<b>Finishing the outdoor unit installation</b>	<b>12</b>
8.1	To finish the outdoor unit installation.....	12
<b>9</b>	<b>Configuration</b>	<b>12</b>
9.1	Facility setting.....	12
9.1.1	To set the facility mode.....	12
<b>10</b>	<b>Commissioning</b>	<b>13</b>
10.1	Checklist before commissioning.....	13
10.2	Checklist during commissioning.....	13
10.3	To perform a test run.....	13
<b>11</b>	<b>Maintenance and service</b>	<b>13</b>
<b>12</b>	<b>Troubleshooting</b>	<b>14</b>
12.1	Fault diagnosis using LED on outdoor unit PCB.....	14
<b>13</b>	<b>Disposal</b>	<b>14</b>
<b>14</b>	<b>Technical data</b>	<b>14</b>
14.1	Wiring diagram.....	14
14.1.1	Unified wiring diagram legend.....	14
14.2	Piping diagram.....	15
14.2.1	Piping diagram: Outdoor unit.....	15

## 1 About the documentation

### 1.1 About this document



#### WARNING

Make sure installation, servicing, maintenance, repair and applied materials follow the instructions from Daikin (including all documents listed in “Documentation set”) and, in addition, comply with applicable legislation and are performed by qualified persons only. In Europe and areas where IEC standards apply, EN/IEC 60335-2-40 is the applicable standard.



#### INFORMATION

Make sure that the user has the printed documentation and ask him/her to keep it for future reference.

#### Target audience

Authorised installers



#### INFORMATION

This document only describes installation instructions specific to the outdoor unit. For installation of the indoor unit (mounting the indoor unit, connecting the refrigerant piping to the indoor unit, connecting the electrical wiring to the indoor unit ...), see the installation manual of the indoor unit.

#### Documentation set

This document is part of a documentation set. The complete set consists of:

- **General safety precautions:**
  - Safety instructions that you **MUST** read before installing
  - Format: Paper (in the box of the outdoor unit)
- **Outdoor unit installation manual:**
  - Installation instructions
  - Format: Paper (in the box of the outdoor unit)
- **Installer reference guide:**
  - Preparation of the installation, reference data, ...
  - Format: Digital files on <https://www.daikin.eu>. Use the search function 🔍 to find your model.

The latest revision of the supplied documentation is published on the regional Daikin website and is available via your dealer.

Scan the QR code below to find the full documentation set and more information about your product on Daikin website.



The original instructions are written in English. All other languages are translations of the original instructions.

#### Technical engineering data

- A **subset** of the latest technical data is available on the regional Daikin website (publicly accessible).
- The **full set** of the latest technical data is available on the Daikin Business Portal (authentication required).

## 2 Specific installer safety instructions

Always observe the following safety instructions and regulations.

**Unit installation** (see "[4 Unit installation](#)" ▶ 7)



### WARNING

Installation shall be done by an installer, the choice of materials and installation shall comply with the applicable legislation. In Europe, EN378 is the applicable standard.

**Installation site** (see "[4.1 Preparing the installation site](#)" ▶ 7)



### CAUTION

- Check if the installation location can support the unit's weight. Poor installation is hazardous. It can also cause vibrations or unusual operating noise.
- Provide sufficient service space.
- Do NOT install the unit so that it is in contact with a ceiling or a wall, as this may cause vibrations.



### WARNING

The appliance shall be stored so as to prevent mechanical damage and in a well-ventilated room without continuously operating ignition sources (e.g. open flames, an operating gas appliance, or an operating electric heater). The room size shall be as specified in the General safety precaution.

**Piping installation** (see "[5 Piping installation](#)" ▶ 8)



### CAUTION

Piping and joints of a split system shall be made with permanent joints when inside an occupied space except joints directly connecting the piping to the indoor units.



### CAUTION

- No brazing or welding on site for units with R32 refrigerant charge during shipment.
- During installation of the refrigeration system, joining of parts with at least one part charged shall be performed taking into account the following requirements: inside occupied spaces non-permanent joints are NOT allowed for R32 refrigerant except for site made joints directly connecting the indoor unit to piping. Site made joints directly connecting piping to indoor units shall be of non-permanent type.



### WARNING

Connect the refrigerant piping securely before running the compressor. If the refrigerant piping is NOT connected and the stop valve is open when the compressor is run, air will be sucked in. This will cause abnormal pressure in the refrigeration cycle, which may result in equipment damage and even injury.



### CAUTION

- Incomplete flaring may cause refrigerant gas leakage.
- Do NOT re-use flares. Use new flares to prevent refrigerant gas leakage.
- Use flare nuts that are included with the unit. Using different flare nuts may cause refrigerant gas leakage.



### CAUTION

Do NOT open the valves before flaring is complete. This would cause refrigerant gas leakage.



### DANGER: RISK OF EXPLOSION

Do NOT open the stop valves before the vacuum drying is finished.

**Charging refrigerant** (see "[6 Charging refrigerant](#)" ▶ 10)



### WARNING

- The refrigerant inside the unit is mildly flammable, but normally does NOT leak. If the refrigerant leaks in the room and comes in contact with fire from a burner, a heater, or a cooker, this may result in fire, or the formation of a harmful gas.
- Turn OFF any combustible heating devices, ventilate the room, and contact the dealer where you purchased the unit.
- Do NOT use the unit until a service person confirms that the part from which the refrigerant leaked has been repaired.



### WARNING

- Only use R32 as refrigerant. Other substances may cause explosions and accidents.
- R32 contains fluorinated greenhouse gases. Its global warming potential (GWP) value is 675. Do NOT vent these gases into the atmosphere.
- When charging refrigerant, ALWAYS use protective gloves and safety glasses.



### WARNING

NEVER directly touch any accidental leaking refrigerant. This could result in severe wounds caused by frostbite.

**Electrical installation** (see "[7 Electrical installation](#)" ▶ 11)



### WARNING

- All wiring MUST be performed by an authorised electrician and MUST comply with the national wiring regulation.
- Make electrical connections to the fixed wiring.
- All components procured on-site and all electrical construction MUST comply with the applicable legislation.



### WARNING

- If the power supply has a missing or wrong N-phase, equipment might break down.
- Establish proper earthing. Do NOT earth the unit to a utility pipe, surge absorber, or telephone earth. Incomplete earthing may cause electrical shocks.
- Install the required fuses or circuit breakers.
- Secure the electrical wiring with cable ties so that the cables do NOT come in contact with sharp edges or piping, particularly on the high-pressure side.
- Do NOT use taped wires, extension cords, or connections from a star system. They can cause overheating, electrical shocks or fire.
- Do NOT install a phase advancing capacitor, because this unit is equipped with an inverter. A phase advancing capacitor will reduce performance and may cause accidents.



### WARNING

ALWAYS use multicore cable for power supply cables.

## 3 About the box

### WARNING

Use an all-pole disconnection type breaker with at least 3 mm between the contact point gaps that provides full disconnection under overvoltage category III.

### WARNING

If the supply cord is damaged, it **MUST** be replaced by the manufacturer, its service agent or similarly qualified persons in order to avoid a hazard.

### WARNING

Do **NOT** connect the power supply to the indoor unit. This could result in electrical shock or fire.

### WARNING

- Do **NOT** use locally purchased electrical parts inside the product.
- Do **NOT** branch the power supply for the drain pump, etc. from the terminal block. This could result in electrical shock or fire.

### WARNING

Keep the interconnection wiring away from copper pipes without thermal insulation as such pipes will be very hot.

### DANGER: RISK OF ELECTROCUTION

All electrical parts (including thermistors) are powered by the power supply. Do **NOT** touch them with bare hands.

### Finishing indoor unit installation (see "8 Finishing the outdoor unit installation" [p 12])

### DANGER: RISK OF ELECTROCUTION

- Make sure that the system is earthed properly.
- Turn **OFF** the power supply before servicing.
- Install the switch box cover before turning **ON** the power supply.

### Commissioning (see "10 Commissioning" [p 13])

### DANGER: RISK OF ELECTROCUTION

### DANGER: RISK OF BURNING/SCALDING

### CAUTION

Do **NOT** perform the test operation while working on the indoor units.

When performing the test operation, **NOT ONLY** the outdoor unit, but the connected indoor unit will operate as well. Working on an indoor unit while performing a test operation is dangerous.

### CAUTION

Do **NOT** insert fingers, rods or other objects into the air inlet or outlet. Do **NOT** remove the fan guard. When the fan is rotating at high speed, it will cause injury.

### Maintenance and service (see "11 Maintenance and service" [p 13])

### DANGER: RISK OF ELECTROCUTION

### DANGER: RISK OF BURNING/SCALDING

### DANGER: RISK OF ELECTROCUTION

Disconnect the power supply for more than 10 minutes, and measure the voltage at the terminals of main circuit capacitors or electrical components before servicing. The voltage **MUST** be less than 50 V DC before you can touch electrical components. For the location of the terminals, see the wiring diagram.

### WARNING

- Before carrying out any maintenance or repair activity, **ALWAYS** switch off the circuit breaker on the supply panel, remove the fuses or open the protection devices of the unit.
- Do **NOT** touch live parts for 10 minutes after the power supply is turned off because of high voltage risk.
- Please note that some sections of the electric component box are hot.
- Make sure you do **NOT** touch a conductive section.
- Do **NOT** rinse the unit. This may cause electric shocks or fire.

### About the compressor

### DANGER: RISK OF ELECTROCUTION

- Use this compressor on a grounded system only.
- Turn the power off before servicing the compressor.
- Reattach the switch box cover and service lid after servicing.

### CAUTION

**ALWAYS** wear safety glasses and protective gloves.

### DANGER: RISK OF EXPLOSION

- Use a pipe cutter to remove the compressor.
- Do **NOT** use the brazing torch.
- Use approved refrigerants and lubricants only.

### DANGER: RISK OF BURNING/SCALDING

Do **NOT** touch the compressor with bare hands.

## 3 About the box

### 3.1 Outdoor unit

#### 3.1.1 To remove the accessories from the outdoor unit

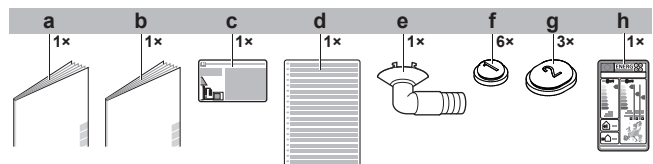

- a General safety precautions
- b Outdoor unit installation manual
- c Fluorinated greenhouse gases label
- d Multilingual fluorinated greenhouse gases label
- e Drain plug (located on the bottom of the packing case)
- f Drain cap (1)
- g Drain cap (2)
- h Energy label

## 4 Unit installation



### WARNING

Installation shall be done by an installer, the choice of materials and installation shall comply with the applicable legislation. In Europe, EN378 is the applicable standard.

### 4.1 Preparing the installation site



### WARNING

The appliance shall be stored so as to prevent mechanical damage and in a well-ventilated room without continuously operating ignition sources (e.g. open flames, an operating gas appliance, or an operating electric heater). The room size shall be as specified in the General safety precaution.

#### 4.1.1 Installation site requirements of the outdoor unit

Mind the following spacing guidelines:

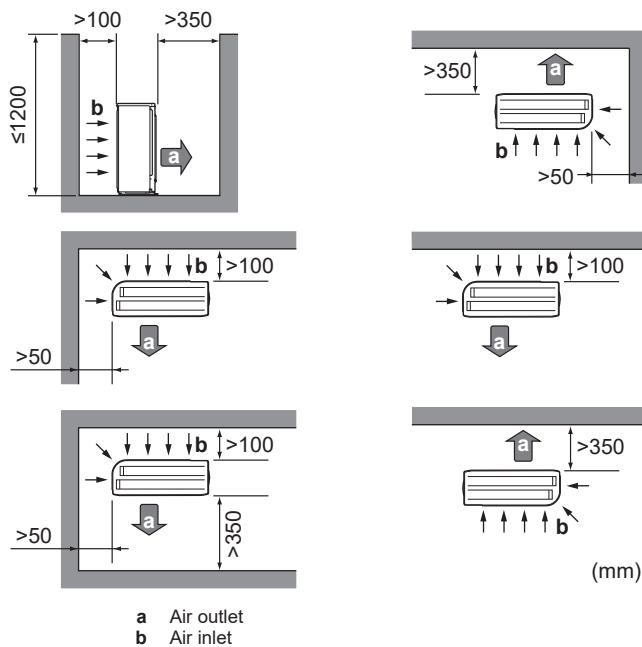

### NOTICE

The height of the wall on the outlet side of the outdoor unit MUST be  $\leq 1200$  mm.

Do NOT install the unit in sound sensitive areas (e.g. near a bedroom), so that the operation noise will cause no trouble.

**Note:** If the sound is measured under actual installation conditions, the measured value might be higher than the sound pressure level mentioned in "Sound spectrum" in the data book due to environmental noise and sound reflections.



### INFORMATION

The sound pressure level is less than 70 dBA.

The outdoor unit is designed for outdoor installation only and for ambient temperatures specified in the table below (unless otherwise specified in the operation manual of the connected indoor unit).

Cooling	Heating
-10~50°C DB	-20~24°C DB

#### 4.1.2 Additional installation site requirements of the outdoor unit in cold climates

Protect the outdoor unit against direct snowfall and take care that the outdoor unit is NEVER snowed up.

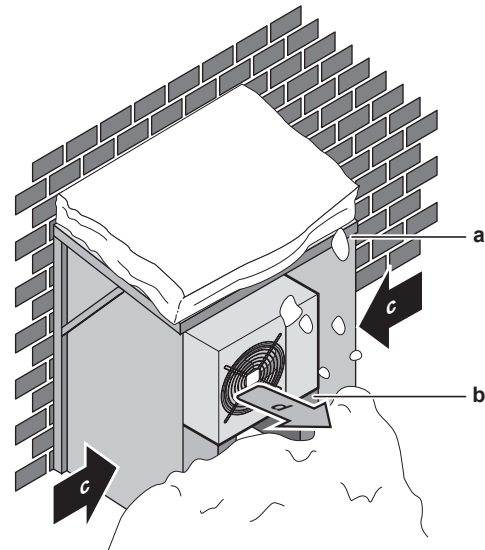

- a Snow cover or shed
- b Pedestal
- c Prevailing wind direction
- d Air outlet

It is recommended to provide at least 150 mm of free space below the unit (300 mm for heavy snowfall areas). Additionally, make sure the unit is positioned at least 100 mm above the maximum expected level of snow. If necessary, construct a pedestal. See "4.2 Mounting the outdoor unit" [p 7] for more details.

In heavy snowfall areas it is very important to select an installation site where the snow will NOT affect the unit. If lateral snowfall is possible, make sure that the heat exchanger coil is NOT affected by the snow. If necessary, install a snow cover or shed and a pedestal.

## 4.2 Mounting the outdoor unit

### 4.2.1 To provide the installation structure

Use a vibration-proof rubber (field supply) in cases where vibrations may be transmitted to the building.

Prepare 4 sets of M8 or M10 anchor bolts, nuts and washers (field supply).

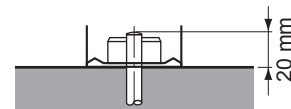

## 5 Piping installation

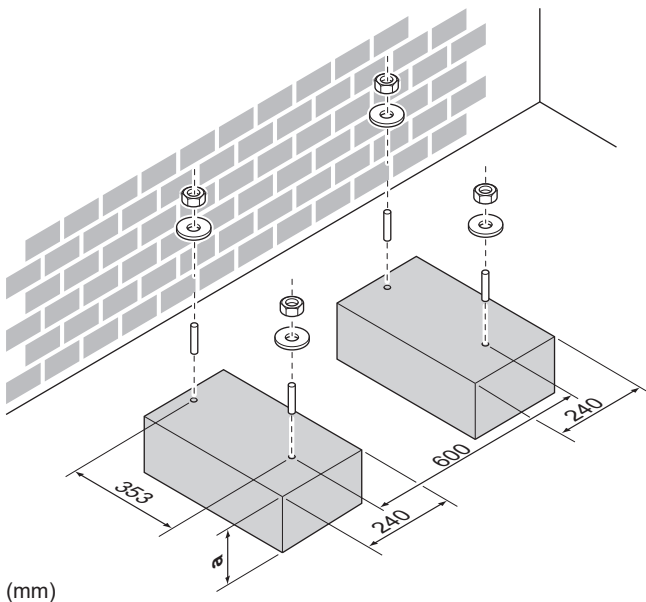

a 100 mm above expected level of snow

### 4.2.2 To install the outdoor unit

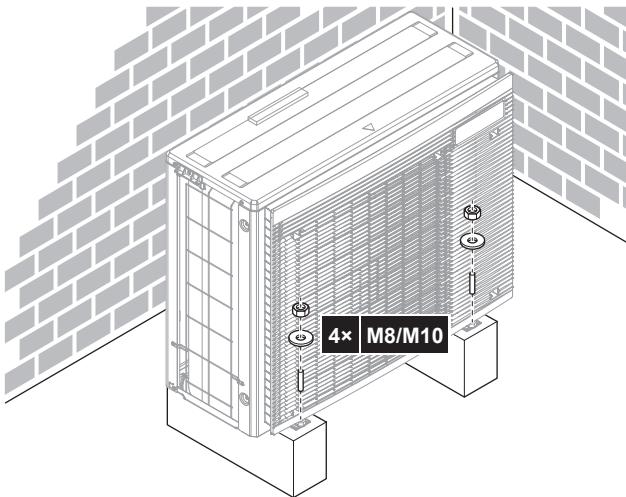

### 4.2.3 To provide drainage

#### NOTICE

If the unit is installed in a cold climate, take adequate measures so that the evacuated condensate CANNOT freeze.

#### NOTICE

If the drain holes of the outdoor unit are blocked up by a mounting base or floor surface, place additional foot bases  $\leq 30$  mm under the outdoor unit's feet.

#### INFORMATION

For information on the available options, contact your dealer.

- 1 Use a drain plug for drainage.
- 2 Use a  $\varnothing 16$  mm hose (field supply).

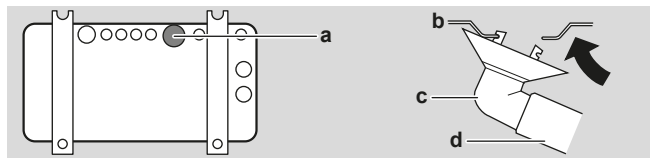

- a Drain port
- b Bottom frame
- c Drain plug
- d Hose (field supply)

### To close the drain holes and attach the drain socket

#### NOTICE

In cold areas, do NOT use a drain socket, hose and caps (1, 2) with the outdoor unit. Take adequate measures so that the evacuated condensate CANNOT freeze.

- 1 Install drain caps 1 and 2 (accessory). Make sure the edges of the drain caps close off the holes completely.

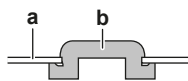

- a Bottom frame
- b Drain cap

- 2 Install the drain socket.

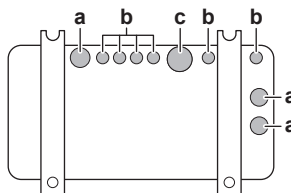

- a Drain hole. Install a drain cap (2).
- b Drain hole. Install a drain cap (1).
- c Drain hole for drain socket

## 5 Piping installation

### 5.1 Preparing refrigerant piping

#### 5.1.1 Refrigerant piping requirements

#### CAUTION

Piping and joints of a split system shall be made with permanent joints when inside an occupied space except joints directly connecting the piping to the indoor units.

#### NOTICE

The piping and other pressure-containing parts shall be suitable for refrigerant. Use phosphoric acid deoxidised seamless copper for refrigerant piping.

- Foreign materials inside pipes (including oils for fabrication) must be  $\leq 30$  mg/10 m.

#### Refrigerant piping diameter

Use the same diameters as the connections on the outdoor units:

Pipe outer diameter	
Liquid piping	Gas piping
$\varnothing 6.4$ mm (1/4")	$\varnothing 12.7$ mm (1/2")

#### Refrigerant piping material

- Piping material: phosphoric acid deoxidised seamless copper



- **Flare connections:** Only use annealed material.
- **Piping temper grade and thickness:**

Outer diameter (Ø)	Temper grade	Thickness (t) <sup>(a)</sup>	
6.4 mm (1/4")	Annealed (O)	≥0.8 mm	
12.7 mm (1/2")			

<sup>(a)</sup> Depending on the applicable legislation and the maximum working pressure of the unit (see "PS High" on the unit name plate), larger piping thickness might be required.

## 5.1.2 Refrigerant piping insulation

- Use polyethylene foam as insulation material:
  - with a heat transfer rate between 0.041 and 0.052 W/mK (0.035 and 0.045 kcal/mh°C)
  - with a heat resistance of at least 120°C
- Insulation thickness:

Pipe outer diameter (Ø <sub>p</sub> )	Insulation inner diameter (Ø <sub>i</sub> )	Insulation thickness (t)
6.4 mm (1/4")	8~10 mm	≥10 mm
12.7 mm (1/2")	14~16 mm	≥13 mm

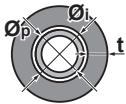

If the temperature is higher than 30°C and the humidity is higher than RH 80%, the thickness of the insulation materials should be at least 20 mm to prevent condensation on the surface of the insulation.

## 5.1.3 Refrigerant piping length and height difference

What?	Distance
Maximum allowable pipe length	30 m
Minimum allowable pipe length	3 m
Maximum allowable height distance	20 m

## 5.2 Connecting the refrigerant piping



**DANGER: RISK OF BURNING/SCALDING**



**CAUTION**

- No brazing or welding on site for units with R32 refrigerant charge during shipment.
- During installation of the refrigeration system, joining of parts with at least one part charged shall be performed taking into account the following requirements: inside occupied spaces non-permanent joints are NOT allowed for R32 refrigerant except for site made joints directly connecting the indoor unit to piping. Site made joints directly connecting piping to indoor units shall be of non-permanent type.

### 5.2.1 To connect the refrigerant piping to the outdoor unit

- **Piping length.** Keep field piping as short as possible.
- **Piping protection.** Protect the field piping against physical damage.



**WARNING**

Connect the refrigerant piping securely before running the compressor. If the refrigerant piping is NOT connected and the stop valve is open when the compressor is run, air will be sucked in. This will cause abnormal pressure in the refrigeration cycle, which may result in equipment damage and even injury.



**NOTICE**

- Use the flare nut fixed to the unit.
- To prevent gas leakage, apply refrigeration oil ONLY to the inside of the flare. Use refrigeration oil for R32 (FW68DA).
- Do NOT reuse joints.

- 1 Connect the liquid refrigerant connection from the indoor unit to the liquid stop valve of the outdoor unit.

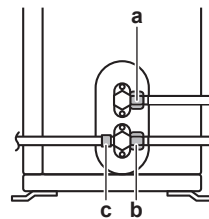

- a Liquid stop valve
- b Gas stop valve
- c Service port

- 2 Connect the gas refrigerant connection from the indoor unit to the gas stop valve of the outdoor unit.



**NOTICE**

It is recommended that the refrigerant piping between indoor and outdoor unit is installed in a ducting or the refrigerant piping is wrapped with finishing tape.

## 5.3 Checking the refrigerant piping

### 5.3.1 To check for leaks



**NOTICE**

Do NOT exceed the unit's maximum working pressure (see "PS High" on the unit name plate).

- 1 Charge the system with nitrogen gas up to a gauge pressure of at least 200 kPa (2 bar). It is recommended to pressurize to 3000 kPa (30 bar) in order to detect small leaks.
- 2 Check for leaks by applying the bubble test solution to all connections.



**NOTICE**

ALWAYS use a recommended bubble test solution from your wholesaler.

NEVER use soap water:

- Soap water may cause cracking of components, such as flare nuts or stop valve caps.
- Soap water may contain salt, which absorbs moisture that will freeze when the piping gets cold.
- Soap water contains ammonia which may lead to corrosion of flared joints (between the brass flare nut and the copper flare).

- 3 Discharge all nitrogen gas.

## 6 Charging refrigerant

### 5.3.2 To perform vacuum drying



#### DANGER: RISK OF EXPLOSION

Do NOT open the stop valves before the vacuum drying is finished.

- 1 Vacuum the system until the pressure on the manifold indicates  $-0.1$  MPa ( $-1$  bar).
- 2 Leave as is for 4-5 minutes and check the pressure:

If the pressure...	Then...
Does not change	There is no moisture in the system. This procedure is finished.
Increases	There is moisture in the system. Go to the next step.

- 3 Vacuum the system for at least 2 hours to a manifold pressure of  $-0.1$  MPa ( $-1$  bar).
- 4 After turning the pump OFF, check the pressure for at least 1 hour.
- 5 If you do NOT reach the target vacuum or CANNOT maintain the vacuum for 1 hour, do the following:
  - Check for leaks again.
  - Perform vacuum drying again.



#### NOTICE

Make sure to open the stop valves after installing the refrigerant piping and performing vacuum drying. Running the system with the stop valves closed may break the compressor.

## 6 Charging refrigerant

### 6.1 About the refrigerant

This product contains fluorinated greenhouse gases. Do NOT vent gases into the atmosphere.

Refrigerant type: R32

Global warming potential (GWP) value: 675

Periodical inspections for refrigerant leaks may be required depending on the applicable legislation. Contact your installer for more information.



#### A2L WARNING: MILDLY FLAMMABLE MATERIAL

The refrigerant inside this unit is mildly flammable.



#### WARNING

- The refrigerant inside the unit is mildly flammable, but normally does NOT leak. If the refrigerant leaks in the room and comes in contact with fire from a burner, a heater, or a cooker, this may result in fire, or the formation of a harmful gas.
- Turn OFF any combustible heating devices, ventilate the room, and contact the dealer where you purchased the unit.
- Do NOT use the unit until a service person confirms that the part from which the refrigerant leaked has been repaired.



#### WARNING

The appliance shall be stored so as to prevent mechanical damage and in a well-ventilated room without continuously operating ignition sources (e.g. open flames, an operating gas appliance, or an operating electric heater). The room size shall be as specified in the General safety precaution.



#### WARNING

- Do NOT pierce or burn refrigerant cycle parts.
- Do NOT use cleaning materials or means to accelerate the defrosting process other than those recommended by the manufacturer.
- Be aware that the refrigerant inside the system is odourless.



#### WARNING

NEVER directly touch any accidental leaking refrigerant. This could result in severe wounds caused by frostbite.

### 6.2 To determine the additional refrigerant amount

If the total liquid piping length is...	Then...
$\leq 10$ m	Do NOT add additional refrigerant.
$> 10$ m	$R = (\text{total length (m) of liquid piping} - 10 \text{ m}) \times 0.020$ $R = \text{Additional charge (kg) (rounded in units of 0.01 kg)}$



#### INFORMATION

Piping length is the one-way length of liquid piping.

### 6.3 To determine the complete recharge amount



#### INFORMATION

If a complete recharge is necessary, the total refrigerant charge is: the factory refrigerant charge (see unit name plate) + the determined additional amount.

### 6.4 To charge additional refrigerant



#### WARNING

- Only use R32 as refrigerant. Other substances may cause explosions and accidents.
- R32 contains fluorinated greenhouse gases. Its global warming potential (GWP) value is 675. Do NOT vent these gases into the atmosphere.
- When charging refrigerant, ALWAYS use protective gloves and safety glasses.

**Prerequisite:** Before charging refrigerant, make sure the refrigerant piping is connected and checked (leak test and vacuum drying).

- 1 Connect the refrigerant cylinder to the service port.
- 2 Charge the additional refrigerant amount.
- 3 Open the gas stop valve.

### 6.5 To check refrigerant piping joints for leaks after charging refrigerant

- 1 Perform the leak tests see "[5.3 Checking the refrigerant piping](#)" [p. 9].

- 2 Charge refrigerant.
- 3 Check for refrigerant leaks after charging (see below)

### Tightness test of field-made refrigerant joints indoors

- 1 Use a leakage test method with a minimum sensitivity of 5 g of refrigerant/year. Test leaks using a pressure of at least 0.25 times the maximum working pressure (see "PS High" on the unit nameplate).

### If a leak is detected

- 1 Recover the refrigerant, repair the joint, and repeat the test.

## 6.6 To fix the fluorinated greenhouse gases label

- 1 Fill in the label as follows:

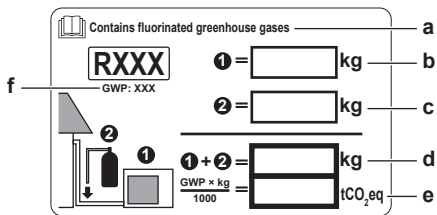

- If a multilingual fluorinated greenhouse gases label is delivered with the unit (see accessories), peel off the applicable language and stick it on top of a.
- Factory refrigerant charge: see unit name plate
- Additional refrigerant amount charged
- Total refrigerant charge
- Quantity of fluorinated greenhouse gases** of the total refrigerant charge expressed as tonnes CO<sub>2</sub> equivalent.
- GWP = Global Warming Potential



### NOTICE

Applicable legislation on **fluorinated greenhouse gases** requires that the refrigerant charge of the unit is indicated both in weight and CO<sub>2</sub> equivalent.

**Formula to calculate the quantity in CO<sub>2</sub> equivalent tonnes:** GWP value of the refrigerant × total refrigerant charge [in kg] / 1000

Use the GWP value mentioned on the refrigerant charge label.

- 2 Fix the label on the inside of the outdoor unit near the gas and liquid stop valves.

## 7 Electrical installation



### DANGER: RISK OF ELECTROCUTION



### WARNING

- All wiring **MUST** be performed by an authorised electrician and **MUST** comply with the national wiring regulation.
- Make electrical connections to the fixed wiring.
- All components procured on-site and all electrical construction **MUST** comply with the applicable legislation.



### WARNING

ALWAYS use multicore cable for power supply cables.



### WARNING

Use an all-pole disconnection type breaker with at least 3 mm between the contact point gaps that provides full disconnection under overvoltage category III.



### WARNING

If the supply cord is damaged, it **MUST** be replaced by the manufacturer, its service agent or similarly qualified persons in order to avoid a hazard.



### WARNING

Do **NOT** connect the power supply to the indoor unit. This could result in electrical shock or fire.



### WARNING

- Do **NOT** use locally purchased electrical parts inside the product.
- Do **NOT** branch the power supply for the drain pump, etc. from the terminal block. This could result in electrical shock or fire.



### WARNING

Keep the interconnection wiring away from copper pipes without thermal insulation as such pipes will be very hot.



### DANGER: RISK OF ELECTROCUTION

All electrical parts (including thermistors) are powered by the power supply. Do **NOT** touch them with bare hands.

## 7.1 Specifications of standard wiring components



### NOTICE

We recommend using solid (single-core) wires. If stranded wires are used, slightly twist the strands to consolidate the end of the conductor for either direct use in the terminal clamp or insertion in a round crimp-style terminal. Details are described in "Guidelines when connecting the electrical wiring" in the installer reference guide.

Power supply of the product	
Voltage	220~240 V
Frequency	50 Hz
Phase	1~
Current	RXJ42: 12.27 A RXJ50: 12.29 A

Wiring / circuit breaker (field supplied)	
Power supply cable	MUST comply with national wiring regulation 3-core cable Wire size based on the current, but not less than 2.5 mm <sup>2</sup>
Interconnection cable (indoor↔outdoor)	Only use harmonised wire providing double insulation and suitable for applicable voltage 4-core cable Minimum size 1.5 mm <sup>2</sup>
Recommended circuit breaker	13 A
Earth leakage circuit breaker / residual current circuit breaker	MUST comply with national wiring regulation

## 7.2 To connect the electrical wiring to the outdoor unit

- 1 Remove the switch box cover.

## 8 Finishing the outdoor unit installation

- 2 Open the wire clamp.
- 3 Connect the interconnection cable and power supply as follows:

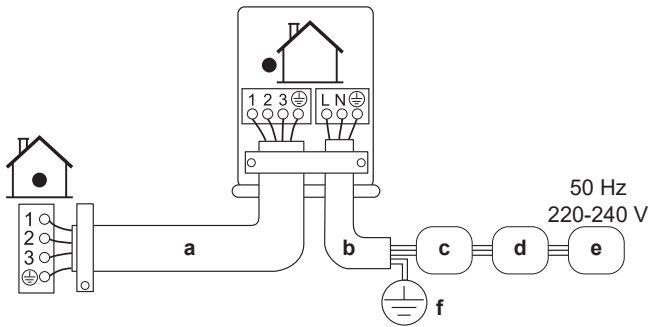

- a Interconnection cable
- b Power supply cable
- c Circuit breaker (field provided fuse with rating according to the model name plate)
- d Residual current device
- e Power supply
- f Earth

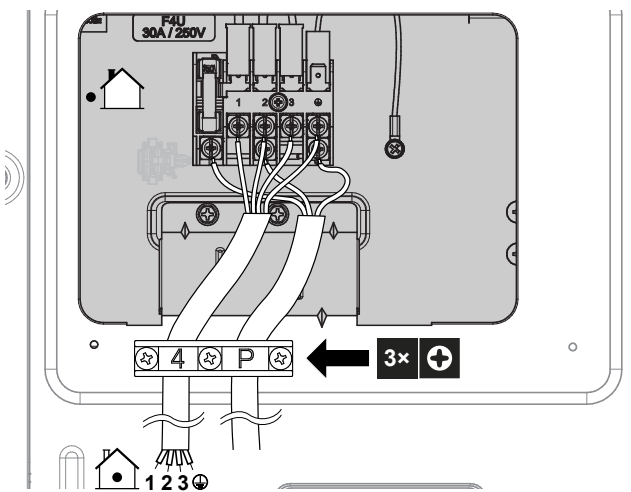

- 4 Tighten the terminal screws securely. We recommend using a Phillips screwdriver.
- 5 Install the switch box cover.

## 8 Finishing the outdoor unit installation

### 8.1 To finish the outdoor unit installation



#### DANGER: RISK OF ELECTROCUTION

- Make sure that the system is earthed properly.
- Turn OFF the power supply before servicing.
- Install the switch box cover before turning ON the power supply.

- 1 Insulate and fix the refrigerant piping and cables as follows:

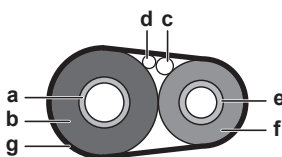

- a Gas pipe
- b Gas pipe insulation
- c Interconnection cable
- d Field wiring (if applicable)

- e Liquid pipe
- f Liquid pipe insulation
- g Finishing tape

- 2 Install the service cover.

## 9 Configuration

### 9.1 Facility setting

Use this function for cooling at low outdoor temperature. This function is designed for facilities such as equipment of computer rooms. NEVER use in a residence or office where people occupy the space.

#### 9.1.1 To set the facility mode

When cutting jumper J12 on the PCB, the operation range will expand to  $-15^{\circ}\text{C}$ . The facility mode will stop if the outdoor temperature drops below  $-20^{\circ}\text{C}$  and resume when the temperature rises again.

##### To cut jumper J12

- 1 Remove the top plate of the outdoor unit.
- 2 Remove the front plate.
- 3 Remove the drip proof cover.
- 4 Cut jumper J12 on the outdoor unit PCB.

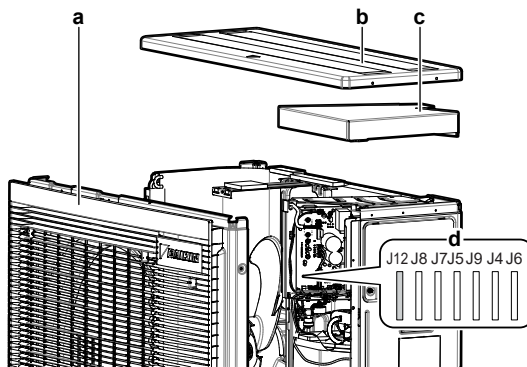

- a Front plate
- b Top plate
- c Drip proof cover
- d Jumpers



#### INFORMATION

- The indoor unit may produce Intermittent noise due to the outdoor unit fan turning ON and/or OFF.
- Do NOT place humidifiers or other items which might raise humidity in rooms when you use the facility mode.
- Cutting jumper J12 sets the indoor unit fan to the highest speed.
- Do NOT use this setting in residences or offices with people.

## 10 Commissioning



### NOTICE

**General commissioning checklist.** Next to the commissioning instructions in this chapter, a general commissioning checklist is also available on the Daikin Business Portal (authentication required).

The general commissioning checklist is complementary to the instructions in this chapter and can be used as a guideline and reporting template during commissioning and hand-over to the user.



### NOTICE

ALWAYS operate the unit with thermistors and/or pressure sensors/switches. If NOT, burning of the compressor might be the result.

### 10.1 Checklist before commissioning

- 1 After the installation of the unit, check the items listed below.
- 2 Close the unit.
- 3 Power up the unit.

<input type="checkbox"/>	The <b>indoor unit</b> is properly mounted.
<input type="checkbox"/>	The <b>outdoor unit</b> is properly mounted.
<input type="checkbox"/>	The system is properly <b>earthed</b> and the earth terminals are tightened.
<input type="checkbox"/>	The <b>power supply voltage</b> matches the voltage on the identification label of the unit.
<input type="checkbox"/>	There are NO <b>loose connections</b> or damaged electrical components in the switch box.
<input type="checkbox"/>	There are NO <b>damaged components</b> or <b>squeezed pipes</b> on the inside of the indoor and outdoor units.
<input type="checkbox"/>	There are NO <b>refrigerant leaks</b> .
<input type="checkbox"/>	The <b>refrigerant pipes</b> (gas and liquid) are thermally insulated.
<input type="checkbox"/>	The correct pipe size is installed and the <b>pipes</b> are properly insulated.
<input type="checkbox"/>	The <b>stop valves</b> (gas and liquid) on the outdoor unit are fully open.
<input type="checkbox"/>	The following <b>field wiring</b> has been carried out according to this document and the applicable legislation between the outdoor unit and the indoor unit.
<input type="checkbox"/>	<b>Drainage</b> Make sure drainage flows smoothly. <b>Possible consequence:</b> Condensate water might drip.
<input type="checkbox"/>	The indoor unit receives the signals of the <b>user interface</b> .
<input type="checkbox"/>	The specified wires are used for the <b>interconnection cable</b> .
<input type="checkbox"/>	The <b>fuses, circuit breakers</b> , or locally installed protection devices are installed according to this document, and have NOT been bypassed.

### 10.2 Checklist during commissioning

<input type="checkbox"/>	To perform an <b>air purge</b> .
<input type="checkbox"/>	To perform a <b>test run</b> .

### 10.3 To perform a test run



### INFORMATION

If the unit runs into an error during commissioning, see the service manual for the detailed troubleshooting guidelines.

**Prerequisite:** The power supply MUST be in the specified range.

**Prerequisite:** Test run may be performed in cooling or heating mode.

**Prerequisite:** Refer to the operation manual of the indoor unit for setting temperature, operation mode....

- 1 In cooling mode, select the lowest programmable temperature. In heating mode, select the highest programmable temperature. The test run can be disabled if necessary.
- 2 When the test run is finished, set the temperature to a normal level. In cooling mode: 26~28°C, in heating mode: 20~24°C.
- 3 Make sure that all functions and parts are working properly.
- 4 The system stops operating 3 minutes after the unit is turned OFF.



### INFORMATION

- Even if the unit is turned OFF, it consumes electricity.
- When the power turns back on after a power break, the previously selected mode will be resumed.

## 11 Maintenance and service



### NOTICE

**General maintenance/inspection checklist.** Next to the maintenance instructions in this chapter, a general maintenance/inspection checklist is also available on the Daikin Business Portal (authentication required).

The general maintenance/inspection checklist is complementary to the instructions in this chapter and can be used as a guideline and reporting template during maintenance.



### NOTICE

Maintenance MUST be done by an authorised installer or service agent.

We recommend performing maintenance at least once a year. However, applicable legislation might require shorter maintenance intervals.



### NOTICE

Applicable legislation on **fluorinated greenhouse gases** requires that the refrigerant charge of the unit is indicated both in weight and CO<sub>2</sub> equivalent.

**Formula to calculate the quantity in CO<sub>2</sub> equivalent tonnes:** GWP value of the refrigerant × total refrigerant charge [in kg] / 1000



### DANGER: RISK OF ELECTROCUTION

Disconnect the power supply for more than 10 minutes, and measure the voltage at the terminals of main circuit capacitors or electrical components before servicing. The voltage between “+” and “-” measuring points MUST be less than 50 V DC before you can touch electrical components. Refer to the following figure.

## 12 Troubleshooting

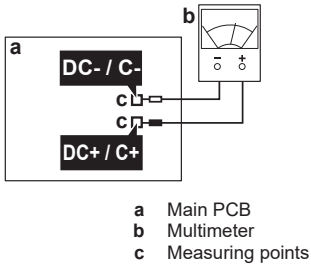

## 12 Troubleshooting

### 12.1 Fault diagnosis using LED on outdoor unit PCB

LED is...	Diagnosis
flashing	Normal → check the indoor unit.
ON	Turn the power OFF and back ON, and check the LED within approximately 3 minutes. → If the LED is ON again, the outdoor unit PCB is faulty.
OFF	<ol style="list-style-type: none"> <li>Supply voltage (for power saving).</li> <li>Power supply fault.</li> <li>Turn the power OFF and back ON, and check the LED within approximately 3 minutes. → If the LED is OFF again, the outdoor unit PCB is faulty.</li> </ol>

#### NOTICE

For error code diagnosis use the wireless remote control delivered with the indoor unit. See the service manual for the complete list of error codes and a detailed troubleshooting guideline for each error.

#### DANGER: RISK OF ELECTROCUTION

- When the unit is NOT operating, the LEDs on the PCB are turned OFF in order to save power.
- Even when the LEDs are OFF, the terminal block and the PCB may be powered.

## 13 Disposal

#### NOTICE

Do NOT try to dismantle the system yourself: dismantling of the system, treatment of the refrigerant, oil and other parts MUST comply with applicable legislation. Units MUST be treated at a specialised treatment facility for reuse, recycling and recovery.

#### INFORMATION

To protect the environment, make sure to perform an automatic pump down operation when relocating or dismantling the unit. For the pump down procedure, refer to the service manual or the installer reference guide.

## 14 Technical data

- A **subset** of the latest technical data is available on the regional Daikin website (publicly accessible).
- The **full set** of the latest technical data is available on the Daikin Business Portal (authentication required).

## 14.1 Wiring diagram

The wiring diagram is delivered with the unit, located inside of the outdoor unit (bottom side of the top plate).

### 14.1.1 Unified wiring diagram legend

For applied parts and numbering, refer to the wiring diagram on the unit. Part numbering is by Arabic numbers in ascending order for each part and is represented in the overview below by "\*" in the part code.

Symbol	Meaning	Symbol	Meaning
	Circuit breaker		Protective earth
			Noiseless earth
			Protective earth (screw)
	Connection		Rectifier
	Connector		Relay connector
	Earth		Short-circuit connector
	Field wiring		Terminal
	Fuse		Terminal strip
	Indoor unit		Wire clamp
	Outdoor unit		Heater
	Residual current device		

Symbol	Colour	Symbol	Colour
BLK	Black	ORG	Orange
BLU	Blue	PNK	Pink
BRN	Brown	PRP, PPL	Purple
GRN	Green	RED	Red
GRY	Grey	WHT	White
SKY BLU	Sky blue	YLW	Yellow

Symbol	Meaning
A*P	Printed circuit board
BS*	Pushbutton ON/OFF, operation switch
BZ, H*O	Buzzer
C*	Capacitor
AC*, CN*, E*, HA*, HE*, HL*, HN*, HR*, MR*_A, MR*_B, S*, U, V, W, X*A, K*R_*, NE	Connection, connector
D*, V*D	Diode
DB*	Diode bridge
DS*	DIP switch
E*H	Heater
FU*, F*U, (for characteristics, refer to PCB inside your unit)	Fuse
FG*	Connector (frame ground)
H*	Harness
H*P, LED*, V*L	Pilot lamp, light emitting diode
HAP	Light emitting diode (service monitor green)
HIGH VOLTAGE	High voltage
IES	Intelligent eye sensor
IPM*	Intelligent power module

Symbol	Meaning
K*R, KCR, KFR, KHuR, K*M	Magnetic relay
L	Live
L*	Coil
L*R	Reactor
M*	Stepper motor
M*C	Compressor motor
M*F	Fan motor
M*P	Drain pump motor
M*S	Swing motor
MR*, MRCW*, MRM*, MRN*	Magnetic relay
N	Neutral
n=*, N=*	Number of passes through ferrite core
PAM	Pulse-amplitude modulation
PCB*	Printed circuit board
PM*	Power module
PS	Switching power supply
PTC*	PTC thermistor
Q*	Insulated gate bipolar transistor (IGBT)
Q*C	Circuit breaker
Q*DI, KLM	Earth leak circuit breaker
Q*L	Overload protector
Q*M	Thermo switch
Q*R	Residual current device
R*	Resistor
R*T	Thermistor
RC	Receiver
S*C	Limit switch
S*L	Float switch
S*NG	Refrigerant leak detector
S*NPH	Pressure sensor (high)
S*NPL	Pressure sensor (low)
S*PH, HPS*	Pressure switch (high)
S*PL	Pressure switch (low)
S*T	Thermostat
S*RH	Humidity sensor
S*W, SW*	Operation switch
SA*, F1S	Surge arrester
SR*, WLU	Signal receiver
SS*	Selector switch
SHEET METAL	Terminal strip fixed plate
T*R	Transformer
TC, TRC	Transmitter
V*, R*V	Varistor

















Symbol	Meaning
V*R	Diode bridge, Insulated-gate bipolar transistor (IGBT) power module
WRC	Wireless remote controller
X*	Terminal
X*M	Terminal strip (block)
Y*E	Electronic expansion valve coil
Y*R, Y*S	Reversing solenoid valve coil
Z*C	Ferrite core
ZF, Z*F	Noise filter

## 14.2 Piping diagram

### 14.2.1 Piping diagram: Outdoor unit

PED categories of equipment:

- High pressure switch: category IV,
- Compressor: category II;
- Other equipment: art. 4§3.

Piping diagram legend	
	Liquid stop valve
	Gas stop valve
	Muffler
	Muffler with filter
	Electronic expansion valve
	Filter
	Propeller fan
	High pressure switch (automatic reset)
	Thermistor
	Capillary tube
	4-way valve
	Accumulator
	Compressor
	Heat exchanger
	Distributor
	Refrigerant flow: Cooling
	Refrigerant flow: Heating
Field piping	Field piping

# 14 Technical data

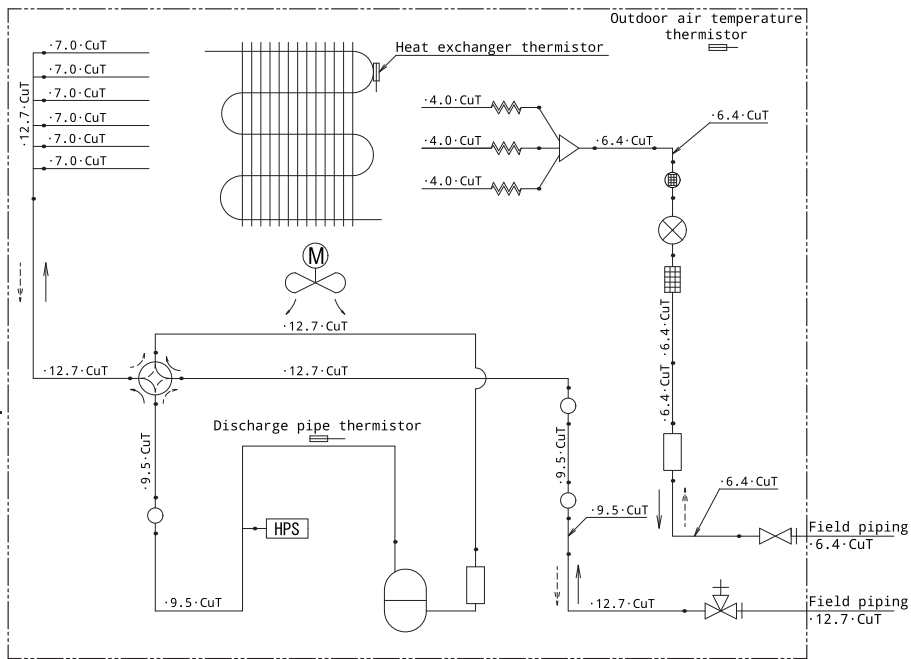









ERC



**DAIKIN ISITMA VE SOĞUTMA SİSTEMLERİ SAN.TİC. A.Ş.**

Gülsuyu Mahallesi, Fevzi Çakmak Caddesi, Burçak Sokak, No:20, 34848 Maltepe  
İSTANBUL / TÜRKİYE  
Tel: 0216 453 27 00  
Faks: 0216 671 06 00  
Çağrı Merkezi: 444 999 0  
Web: www.daikin.com.tr

**DAIKIN EUROPE N.V.**

Zandvoordestraat 300, B-8400 Oostende, Belgium

Copyright 2024 Daikin

3P766062-1 2024.01