

User reference guide

Daikin Altherma 4 H F+W

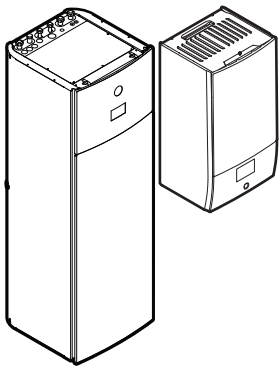

Download the
ONECTA app

 **STAND BY ME**
Discover our service offer

EPVX10S(U)18A▲4V▼
EPVX10S(U)23A▲4V▼
EPVX10S18A▲9W▼
EPVX10S23A▲9W▼
EPVX14S(U)18A▲4V▼
EPVX14S(U)23A▲4V▼
EPVX14S18A▲9W▼
EPVX14S23A▲9W▼

EPBX(U)10A▲4V▼
EPBX10A▲9W▼
EPBX(U)14A▲4V▼
EPBX14A▲9W▼

▲ = 1, 2, 3, ..., 9, A, B, C, ..., Z
▼ = , , 1, 2, 3, ..., 9

Table of contents

| | | |
|----------|--|-----------|
| 1 | About this document | 4 |
| 1.1 | Meaning of warnings and symbols | 6 |
| 2 | User safety instructions | 8 |
| 2.1 | General | 8 |
| 2.2 | Instructions for safe operation | 9 |
| 3 | About the system | 12 |
| 3.1 | Components in a typical system layout | 12 |
| 4 | Quick guide | 13 |
| 4.1 | Turning operation ON or OFF | 13 |
| 4.2 | To change the desired room temperature | 14 |
| 4.3 | To change the desired leaving water temperature | 14 |
| 4.4 | To change the tank temperature setpoint | 15 |
| 5 | Operation | 16 |
| 5.1 | User interface: Overview | 16 |
| 5.1.1 | Menu structure: Overview user settings | 17 |
| 5.1.2 | Possible screens: Overview | 19 |
| 5.1.3 | Reading out information | 23 |
| 5.1.4 | Advanced user permission | 24 |
| 5.2 | Turning operation ON or OFF | 24 |
| 5.3 | Space heating/cooling control | 25 |
| 5.3.1 | About space heating/cooling control | 25 |
| 5.3.2 | About room frost protection | 25 |
| 5.3.3 | Setting the Operation mode | 26 |
| 5.3.4 | Determining which temperature control you are using | 28 |
| 5.3.5 | Capacity shortage | 28 |
| 5.3.6 | Comfort setpoint for energy buffering | 29 |
| 5.3.7 | Room sensor offset | 29 |
| 5.3.8 | To set the Operation Range | 30 |
| 5.3.9 | To set the Emitter type | 30 |
| 5.3.10 | To change the desired room temperature | 30 |
| 5.3.11 | To set the room Hysteresis | 31 |
| 5.3.12 | To change the desired leaving water temperature | 31 |
| 5.3.13 | To enable scheduling | 32 |
| 5.3.14 | To change the Zone name | 32 |
| 5.4 | Domestic hot water control | 33 |
| 5.4.1 | About domestic hot water control | 33 |
| 5.4.2 | Reheat mode | 33 |
| 5.4.3 | Schedule and reheat mode | 34 |
| 5.4.4 | Scheduled mode | 36 |
| 5.4.5 | Single heat-up | 36 |
| 5.4.6 | Additional heat source for DHW | 38 |
| 5.5 | Schedules | 39 |
| 5.5.1 | Using and programming schedules | 39 |
| 5.5.2 | Schedule screen: Example | 43 |
| 5.6 | Weather-dependent curve | 47 |
| 5.6.1 | What is a weather-dependent curve? | 47 |
| 5.6.2 | Using weather-dependent curves | 48 |
| 5.7 | Energy prices | 50 |
| 5.7.1 | Energy price considered | 50 |
| 5.7.2 | To set the fixed electricity price (no scheduling) | 50 |
| 5.7.3 | To set the scheduled electricity baseline price | 51 |
| 5.7.4 | To set the electricity price schedule | 51 |
| 5.7.5 | To set the gas price | 51 |
| 5.7.6 | About energy prices in case of an incentive per kWh renewable energy | 51 |
| 5.8 | Other functionalities | 52 |
| 5.8.1 | To set Time/date | 52 |
| 5.8.2 | To set the Location and language | 52 |
| 5.8.3 | To change the Display brightness | 53 |
| 5.8.4 | To change the Keyboard lay-out | 53 |
| 5.8.5 | Using quiet mode | 53 |
| 5.8.6 | Using holiday mode | 56 |
| 5.8.7 | Using WLAN | 57 |

| | | |
|-----------|---|-----------|
| 5.9 | Emergency operation | 59 |
| 6 | Energy saving tips | 61 |
| 7 | Maintenance and service | 62 |
| 7.1 | Overview: Maintenance and service..... | 62 |
| 8 | Troubleshooting | 63 |
| 8.1 | To display the help text in case of a malfunction | 63 |
| 8.2 | To check the malfunction history | 63 |
| 8.3 | Symptom: You are feeling too cold (hot) in your living room | 64 |
| 8.4 | Symptom: The water at the tap is too cold | 64 |
| 8.5 | Symptom: Heat pump failure..... | 65 |
| 8.6 | Symptom: The system is making gurgling noises after commissioning | 65 |
| 9 | Relocation | 67 |
| 9.1 | Overview: Relocation | 67 |
| 10 | Disposal | 68 |
| 11 | Glossary | 69 |
| 12 | Installer settings: Tables to be filled in by installer | 70 |
| 12.1 | Configuration wizard | 70 |
| 12.2 | Settings menu | 71 |

1 About this document

Thank you for purchasing this product. Please:

- Read the documentation carefully before operating the user interface to ensure the best possible performance.
- Request the installer to inform you about the settings that he used to configure your system. Check if he has filled in the installer settings tables. If NOT, request him to do so.
- Keep the documentation for future reference.

Target audience

End users

Documentation set

This document is part of a documentation set. The complete set consists of:

- **General safety precautions:**
 - Safety instructions that you must read before installing
 - Format: Paper (in the box of the indoor unit)
- **Operation manual:**
 - Quick guide for basic usage
 - Format: Paper (in the box of the indoor unit)
- **User reference guide:**
 - Detailed step-by-step instructions and background information for basic and advanced usage
 - Format: Digital files on <https://www.daikin.eu>. Use the search function 🔍 to find your model.
- **Installation manual – Outdoor unit:**
 - Installation instructions
 - Format: Paper (in the box of the outdoor unit)
- **Installation manual – Indoor unit:**
 - Installation instructions
 - Format: Paper (in the box of the indoor unit)
- **Installer reference guide:**
 - Preparation of the installation, good practices, reference data, ...
 - Format: Digital files on <https://www.daikin.eu>. Use the search function 🔍 to find your model.
- **Configuration reference guide:**
 - Configuration of the system.
 - Format: Digital files on <https://www.daikin.eu>. Use the search function 🔍 to find your model.
- **Addendum book for optional equipment:**
 - Additional info about how to install optional equipment
 - Format: Paper (in the box of the indoor unit) + Digital files on <https://www.daikin.eu>. Use the search function 🔍 to find your model.

Latest revisions of the supplied documentation may be available on the regional Daikin website or via your installer.

The original instructions are written in English. All other languages are translations of the original instructions.

ONECTA app



If set up by your installer, you can use the ONECTA app to control and monitor the status of your system. For more information, see:

<http://www.onlinecontroller.daikineurope.com/>



Breadcrumbs

Breadcrumbs (example: **[3.1]**) help you to locate where you are in the menu structure of the user interface.

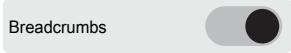
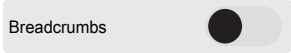
| | |
|----------|---|
| 1 | <p>To enable the breadcrumbs: tap the right arrow on the home screen, then tap Settings.</p> <p>Under [5.4] Settings > Breadcrumbs you can switch breadcrumbs ON:</p>  |
| 2 | <p>To disable the breadcrumbs: navigate to the location as described above, and switch breadcrumbs OFF:</p>  |







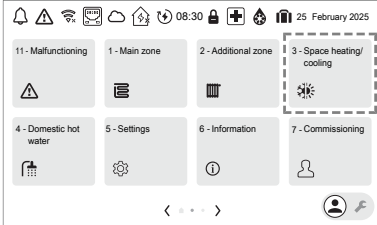
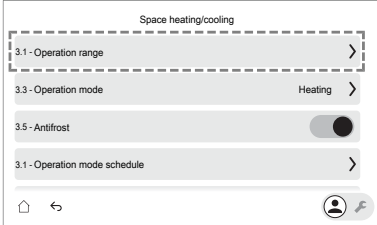

This document also mentions these breadcrumbs. **Example:**

| | |
|----------|--|
| 1 | Go to [3.1]: Space heating/cooling > Operation range . |
|----------|--|





This means:

| | |
|----------|--|
| 1 | <p>Starting from the home screen, tap the right arrow and tap Space heating/cooling.</p>  |
| 2 | <p>Tap Operation range. The breadcrumb (if breadcrumb setting is ON) is visible at the left side of the Operation range label.</p>  |

1.1 Meaning of warnings and symbols



| | |
|---|---|
|  | DANGER Indicates a situation that results in death or serious injury. |
|  | DANGER: RISK OF ELECTROCUTION Indicates a situation that could result in electrocution. |
|  | DANGER: RISK OF BURNING/SCALDING Indicates a situation that could result in burning/scalding because of extreme hot or cold temperatures. |
|  | DANGER: RISK OF EXPLOSION Indicates a situation that could result in explosion. |
|  | WARNING Indicates a situation that could result in death or serious injury. |
|  | WARNING: FLAMMABLE MATERIAL |
|  | CAUTION Indicates a situation that could result in minor or moderate injury. |
|  | NOTICE Indicates a situation that could result in equipment or property damage. |
|  | INFORMATION Indicates useful tips or additional information. |

Symbols used on the unit:

| Symbol | Explanation |
|---|--|
|  | Before installation, read the installation and operation manual, and the wiring instruction sheet. |
|  | Before performing maintenance and service tasks, read the service manual. |
|  | For more information, see the installer and user reference guide. |
|  | The unit contains rotating parts. Be careful when servicing or inspecting the unit. |

Symbols used in the documentation:

| Symbol | Explanation |
|---|---|
|  | Indicates a figure title or a reference to it. Example: "▲ 1-3 Figure title" means "Figure 3 in chapter 1". |

| Symbol | Explanation |
|---|---|
|  | Indicates a table title or a reference to it. Example: "  1-3 Table title" means "Table 3 in chapter 1". |

2 User safety instructions

Always observe the following safety instructions and regulations.

2.1 General



WARNING

If you are NOT sure how to operate the unit, contact your installer.



WARNING

This appliance can be used by children aged from 8 years and above and persons with reduced physical, sensory or mental capabilities or lack of experience and knowledge if they have been given supervision or instruction concerning use of the appliance in a safe way and understand the hazards involved.

Children SHALL NOT play with the appliance.

Cleaning and user maintenance SHALL NOT be made by children without supervision.



WARNING

To prevent electrical shocks or fire:

- Do NOT rinse the unit.
- Do NOT operate the unit with wet hands.
- Do NOT place any objects containing water on the unit.



CAUTION

- Do NOT place any objects or equipment on top of the unit.
- Do NOT sit, climb or stand on the unit.

- Units are marked with the following symbol:



This means that electrical and electronic products may NOT be mixed with unsorted household waste. Do NOT try to dismantle the system yourself: dismantling the system, treatment of the refrigerant, of oil and of other parts MUST be done by an authorised installer and MUST comply with applicable legislation.

Units MUST be treated at a specialised treatment facility for reuse, recycling and recovery. By ensuring this product is disposed of correctly, you will help to prevent potential negative consequences for the environment and human health. For more information, contact your installer or local authority.

- Batteries are marked with the following symbol:



This means that the batteries may NOT be mixed with unsorted household waste. If a chemical symbol is printed beneath the symbol, this chemical symbol means that the battery contains a heavy metal above a certain concentration.

Possible chemical symbols are: Pb: lead (>0.004%).

Waste batteries MUST be treated at a specialised treatment facility for reuse. By ensuring waste batteries are disposed of correctly, you will help to prevent potential negative consequences for the environment and human health.

2.2 Instructions for safe operation



WARNING

If the supply cord is damaged, it MUST be replaced by the manufacturer, its service agent or similarly qualified persons in order to avoid a hazard.



WARNING

The appliance shall be stored in a room without ignition sources (neither permanent ignition sources nor ignition sources for a short period of time) (example: open flames, an operating gas appliance or an operating electric heater).



WARNING

- Do NOT pierce or burn refrigerant cycle parts.
- Do NOT use cleaning materials or means to accelerate the defrosting process other than those recommended by the manufacturer.
- Be aware that the refrigerant inside the system is odourless.



WARNING

After commissioning, do NOT turn OFF the circuit breakers (c) to the units so that the protection remains activated. In case of normal kWh rate power supply (a), there is one circuit breaker. In case of preferential kWh rate power supply (b), there are two.

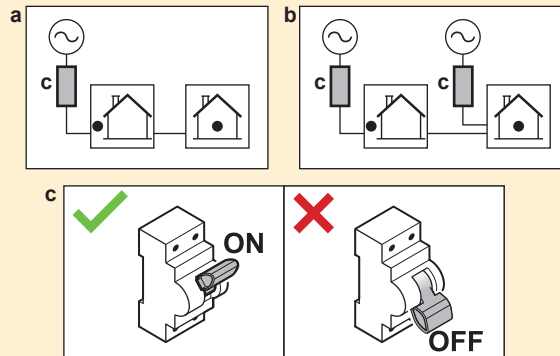

WARNING

To ensure safety in the unlikely event of a refrigerant leak:

- Do NOT bring any ignition sources within the protective zone around the outdoor unit. Neither permanent ignition sources nor ignition sources for a short period of time (example: open flames, ...).
- Do not enclose the area around the outdoor unit to avoid accumulation of refrigerant.



WARNING

Do NOT open the unit (especially the outdoor unit). Both indoor unit and outdoor unit have a gas leak detection sensor. When a flammable gas is detected, the outdoor unit fan will start to rotate in order to dilute the gas with the surrounding air.



WARNING

Do NOT use sprays containing any flammable gas inside or near the unit. This could trigger the gas leak detection and cause the outdoor unit fan to start rotating.

**WARNING**

Air purging heat emitters or collectors. Before you purge air from heat emitters or collectors, check if 🔔 or ⚠️ is displayed on the home screen of the user interface.

- If not, you can purge air immediately.
- If yes, make sure that the room where you want to purge air is sufficiently ventilated. **Reason:** In case of a breakdown, refrigerant might leak into the water circuit, and subsequently into the room when you purge air from the heat emitters or collectors.

3 About the system

Depending on the system layout, the system can:

- Heat up a space
- Cool down a space
- Produce domestic hot water (if a DHW tank is installed)



INFORMATION

If underfloor heating is installed in the main zone, then in cooling mode the main zone can only provide refreshment. Real cooling is then NOT allowed.

3.1 Components in a typical system layout

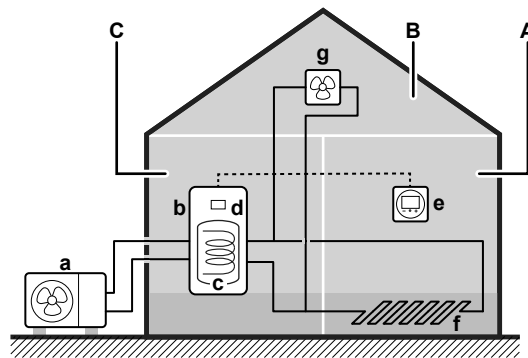

- A** Main zone. **Example:** Living room.
- B** Additional zone. **Example:** Bedroom.
- C** Technical room. **Example:** Garage.
- a** Outdoor unit heat pump
- b** Indoor unit heat pump
- c** Domestic hot water (DHW) tank
- d** User interface of the indoor unit
- e** Dedicated Human Comfort Interface (BRC1HH used as room thermostat)
- f** Underfloor heating
- g** Radiators, heat pump convectors, or fan coil units



INFORMATION

The indoor unit and the domestic hot water tank (if installed) can be separated or integrated depending on the indoor unit type.

4 Quick guide

4.1 Turning operation ON or OFF

Space heating/cooling operation



NOTICE



Room frost protection. Even if you turn OFF space heating/cooling operation, room frost protection operation –if enabled– can still activate. However, for external room thermostat control, the protection is only active in case of a thermostat request.



NOTICE

Water pipe freeze prevention. Even if you turn OFF space heating/cooling operation, water pipe freeze prevention –if enabled– will remain active.

In case you want to turn off ALL space heating/cooling:

| | |
|----------|---|
| 1 | Tap on the Spaces bar from the home screen. |
| 2 | Tap the  icon to turn climate control ON or OFF. |
| 3 | Confirm with the  button. Result: When OFF, the Space heating/cooling screen area on the home screen is greyed out. |

In case you only want to turn off an individual zone:

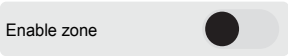
| | |
|----------|---|
| 1 | Restriction: Turning off an individual zone is only possible in case of LWT control. Tap on the emitter icon of a zone on the home screen, OR go to: <ul style="list-style-type: none"> ▪ [1.17] Main zone > Enable zone. ▪ [2.15] Additional zone > Enable zone. |
| 2 | Switch the zone OFF: <div style="text-align: center; margin: 5px 0;">  </div> Result: When OFF, the zone screen area is greyed out. |

Tank heating operation



NOTICE

Disinfection mode. Even if you turn OFF tank heating operation, disinfection mode will remain active (if enabled).



NOTICE

It is recommended to set disinfection mode to once a day (setting [4.10] **Disinfection** > **Every day**).

| | |
|----------|---|
| 1 | Go to [4.1]: Domestic hot water > Single heat-up . Note: Tap on the Domestic hot water bar from the home screen to quickly access [4.1]. |
| 2 | Tap the  icon to turn Domestic hot water ON or OFF. |

| | |
|----------|---|
| 3 | <p>Confirm with the ✓ button.</p> <p>Result: When OFF, the Domestic hot water screen area on the home screen is greyed out.</p> |
|----------|---|

4.2 To change the desired room temperature

During room temperature control, you can use the room temperature setpoint screen to read out and adjust the desired room temperature.

| | |
|----------|---|
| 1 | <p>Go to [1.1] Main zone > Room setpoint.</p> <p>Note: From the home screen, tap on the main zone temperature screen area to quickly access [1.1].</p> |
| 2 | <p>Adjust the desired room temperature:</p>  |
| 3 | <p>Confirm with the ✓ button.</p> |

More information

For more information, see also:

- "4.1 Turning operation ON or OFF" [▶ 13]
- "5.3 Space heating/cooling control" [▶ 25]
- "5.5 Schedules" [▶ 39]

4.3 To change the desired leaving water temperature

In case no weather-dependent curve is used

You can adjust the fixed leaving water temperature as follows:

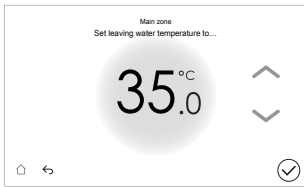
| | |
|----------|---|
| 1 | <p>Go to:</p> <ul style="list-style-type: none"> ▪ [1.39] Main zone > Leaving water temp ▪ [2.30] Additional zone > Leaving water temp <p>Note: From the home screen, tap on the main (or additional) zone temperature screen area to quickly access [1.39] (or [2.30]).</p> <p>Note: In case of weather dependent mode, LWT is not controlled by this setting.</p> |
| 2 | <p>Adjust the desired leaving water temperature:</p>  |
| 3 | <p>Confirm with the ✓ button.</p> |

In case weather-dependent curve is used

Note: For more information on weather-dependent operation, see ["5.6 Weather-dependent curve"](#) [▶ 47].

You can set a temperature shift to the weather-dependent curve leaving water temperature as follows:

| | |
|----------|---|
| 1 | Go to: <ul style="list-style-type: none"> ▪ [1.27] Main zone > Leaving water shift heating ▪ [1.28] Main zone > Leaving water shift cooling ▪ [2.22] Additional zone > Leaving water shift heating ▪ [2.23] Additional zone > Leaving water shift cooling |
| 2 | Adjust the desired leaving water shift temperature. Note: The temperature shift value can be set in 1°C increments. |
| 3 | Confirm with the ✓ button. |

More information

For more information, see also:

- ["4.1 Turning operation ON or OFF"](#) [▶ 13]
- ["5.3 Space heating/cooling control"](#) [▶ 25]
- ["5.5 Schedules"](#) [▶ 39]
- ["5.6 Weather-dependent curve"](#) [▶ 47]

4.4 To change the tank temperature setpoint

To change the tank temperature setpoint

In **Reheat** and **Schedule** and **reheat** mode, you can use the tank temperature setpoint screen to adjust the domestic hot water temperature.

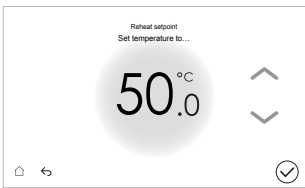
| | |
|----------|---|
| 1 | Go to [4.5]: Domestic hot water > Reheat setpoint. |
| 2 | Adjust the domestic hot water temperature: <div style="border: 1px solid black; padding: 10px; margin: 10px 0;">  </div> |

More information

For more information, see also:

- ["4.1 Turning operation ON or OFF"](#) [▶ 13]
- ["5.4 Domestic hot water control"](#) [▶ 33]
- ["5.5 Schedules"](#) [▶ 39]

5 Operation

5.1 User interface: Overview

The user interface has the following components:

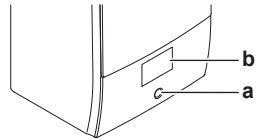

- a Status indicator
- b Touch screen display

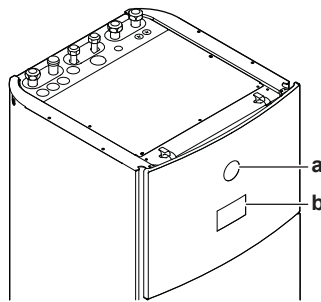

- a Status indicator
- b Touch screen display

Status indicator

The LEDs of the status indicator light up or blink to show the operating mode of the unit.

| LED | Mode | Description |
|-----------------|------------|---|
| Blinking blue | Standby | The unit is not in operation. |
| Continuous blue | Operation | The unit is in operation. |
| Blinking red | Malfunxion | A malfunction occurred. See "8.1 To display the help text in case of a malfunction" [▶ 63] for more information. |

Touchscreen display

The backlight of the touchscreen dims after four minutes of non-interaction with the user interface, and turns off when five minutes have passed. Tapping the touchscreen turns the backlight back on.

Touch gestures

Interaction with the touchscreen display can be done with the following gestures:

| | Gesture | Description |
|--|-------------------|---|
| | Tap | Quickly tapping the touch screen on a specific item or area. |
| | Swipe up/down | One or more fingers touch the screen and move a short distance in up or down direction. |
| | Drag horizontally | Press and hold while moving in a horizontal direction. |

5.1.1 Menu structure: Overview user settings

**INFORMATION**

Depending on the selected installer settings and unit type, settings will be visible/invisible.

**NOTICE**

When changing a setting, the operation is temporarily stopped. Operations will restart when you return to the home screen.

[1] Main zone

- [1.1] Room setpoint/Leaving water temp
- [1.2] Heating schedule enable
- [1.3] Heating schedule
- [1.4] Cooling schedule
- [1.5] Heating setpoint mode (Advanced user)
- [1.7] Cooling setpoint mode (Advanced user)
- [1.8] Heating WD curve
- [1.9] Cooling WD curve
- [1.10] Hysteresis
- [1.11] Emitter type
- [1.17] Enable zone
- [1.21] Zone name
- [1.22] Antifrost
- [1.23] Cooling schedule enable
- [1.24] Leaving water shift heating schedule
- [1.25] Leaving water shift cooling schedule
- [1.27] Leaving water shift heating
- [1.28] Leaving water shift cooling
- [1.29] Heating comfort setpoint (Advanced user)
- [1.30] Cooling comfort setpoint (Advanced user)
- [1.32] Room enable
- [1.33] External room sensor offset (Advanced user)
- [1.34] Heating target baseline
- [1.35] Cooling target baseline
- [1.36] Leaving water shift heating mode
- [1.37] Leaving water shift cooling mode
- [1.38] Thermostat sensor offset (Advanced user)
- [1.39] Leaving water temp

[2] Additional zone

- [2.2] Heating schedule enable
- [2.3] Heating schedule
- [2.4] Cooling schedule
- [2.5] Heating setpoint mode (Advanced user)
- [2.7] Cooling setpoint mode (Advanced user)
- [2.8] Heating WD curve
- [2.9] Cooling WD curve
- [2.11] Emitter type
- [2.15] Enable zone
- [2.18] Leaving water shift heating schedule
- [2.19] Leaving water shift cooling schedule
- [2.21] Zone name
- [2.22] Leaving water shift heating
- [2.23] Leaving water shift cooling
- [2.27] Cooling schedule enable
- [2.30] Leaving water temp
- [2.31] Leaving water shift heating mode
- [2.32] Leaving water shift cooling mode

[3] Space heating/cooling

- [3.1] Operation range
- [3.2] Operation mode
- [3.4] Antifrost (Advanced user)

- [3.5] Operation mode schedule

[4] Domestic hot water

- [4.1] Single heat-up
- [4.3] Manual setpoint
- [4.4] Powerful operation setpoint
- [4.5] Reheat setpoint
- [4.6] Single heat-up schedule
- [4.7] Heat up mode
- [4.12] Hysteresis
- [4.16] Add. source take over during SH/C
- [4.17] Add. source DHW always on request
- [4.19] Reheat Trigger Threshold (Advanced user)
- [4.26] DHW pump schedule

[5] Settings

- [5.2] Quiet operation
- [5.3] Time/date
- [5.4] Breadcrumbs (on/off)
- [5.6] Capacity shortage (Advanced user)
- [5.9] Location and language
- [5.10] Timezone
- [5.12] Keyboard lay-out
- [5.13] Advanced settings
- [5.17] Display brightness
- [5.23] Emergency selection
- [5.26] Display inactivity timer
- [5.27] Holiday (Advanced user)
- [5.30] Emergency acknowledgement

[6] Information

- [6.1] Energy data
- [6.2] Dealer information
- [6.3] Sensors
- [6.4] Actuators
- [6.5] Operation modes
- [6.6] About
- [6.7] Indoor unit model name
- [6.8] Indoor unit serial number

[8] Connectivity

- [8.1] TCP/IP configuration
- [8.2] Connection status
- [8.3] Wireless gateway
- [8.4] Connection details
- [8.5] Daikin Home Controls

[9] Energy

- [9.1] Electricity price (Advanced user)
- [9.2] Electricity price baseline (Advanced user)
- [9.3] Electricity price schedule enable (Advanced user)
- [9.4] Electricity price schedule
- [9.5] Gas price (Advanced user)
- [9.13] Energy price considered (Advanced user)

[11] Malfunctioning

[12] Touch

- [12.1] Touch pointer
- [12.2] Sensor viewer
- [12.3] Draw tool

5.1.2 Possible screens: Overview

**INFORMATION**

Some functions are visualised on the user interface, but are not available for your system.

The most common screens are as follows:







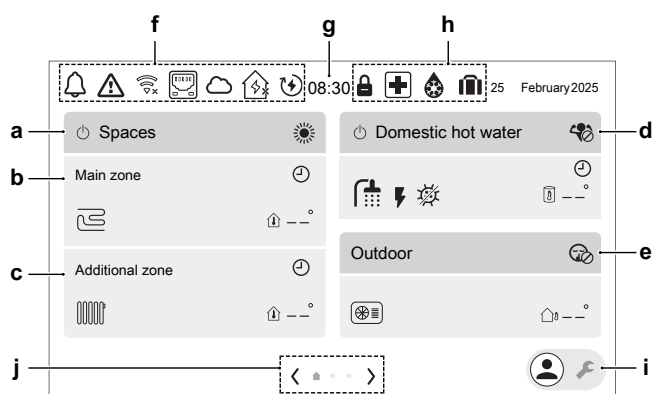

















- Home screen
- Main screen (two screens)
- Setpoint screen



















Home screen

The home screen gives an overview of the unit configuration and the room and setpoint temperatures. Only symbols applicable for your configuration are visible on the home screen.



| Item | Description | |
|-----------|---|----------------------------------|
| a | Spaces Shortcut to setting [1.3]. | |
| a1 | | Climate control ON / OFF |
| a2 | Operation mode: | |
| | | Heating |
| | | Cooling |
| | | Automatic |
| b | Main zone This zone can be renamed in Zone name [1.21]) | |
| b1 | Heat emitter type: | |
| | | Underfloor heating |
| | | Heat pump convector |
| | | Radiator |
| b2 | | Measured temperature (Main zone) |

| Item | Description | |
|-----------|---|---|
| c | Additional zone This zone can be renamed in Zone name [2.21]) | |
| c1 | Heat emitter type: | |
| |  | Underfloor heating |
| |  | Heat pump convector |
| |  | Radiator |
| c2 |  | Measured temperature (Additional zone) |
| d | Domestic hot water Shortcut to setting [4.1]. | |
| d1 |  | Climate control ON / OFF |
| d2 | Powerful operation mode: | |
| |  | Powerful operation mode ON |
| |  | Powerful operation mode OFF |
| d3 |  | Domestic hot water ON |
| d4 |  | Booster heater ON |
| d5 | DHW operation mode: | |
| |  | Disinfection mode active |
| |  | Manual mode ON |
| |  | Powerful operation mode ON |
| |  | Reheat mode active |
| |  | Schedule and reheat mode active |
| |  | Scheduled reheat mode active |
| d6 |  | Measured tank temperature |
| e | Outdoor Shortcut to setting [5.2]. | |
| e1 |  | Outdoor unit |
| e2 | Quiet operation: | |
| |  | Off |
| |  | Manual |
| |  | Scheduled |
| e3 | Quiet operation level: | |
| |  | Quiet |
| |  | More quiet |
| |  | Most quiet |
| e4 |  | Measured outdoor temperature |

| Item | Description | |
|-----------|---|---|
| f | Status icons | |
| f1 |  | A warning occurred. |
| f2 |  | An error occurred. |
| f3 | WiFi | |
| |  | WiFi connected |
| |  | WiFi disconnected |
| f4 |  | LAN connected |
| f5 | Daikin ONECTA | |
| |  | Connected |
| |  | Not connected |
| f6 | Daikin HomeHub | |
| |  | Connected |
| |  | Not connected |
| |  | Warning |
| f7 |  | Smart energy enabled |
| f8 |  | Demo mode is active |
| g | Clock | |
| h | Special functions | |
| h1 |  | Holiday |
| h2 |  | Antifrost |
| h3 |  | Emergency |
| h4 |  | Outdoor unit is in locked state. Note: Unlocking can only be performed by a trained installer. |
| i | Installer switch. To switch between user and installer mode. | |
| |  | User mode |
| |  | Installer mode |
| j | Navigation / pagination | |

Main menu screen

Starting from the home screen, tap the right arrow to view the first main menu screen. Tap the right arrow a second time to view the second main menu screen. From the main menu screens, you can access the different setpoint screens and submenus.

Main menu screen 1:

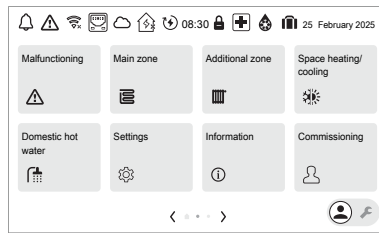

Main menu screen 2:

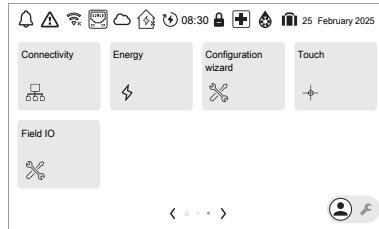

| | Submenu | Description |
|------|-----------------------|---|
| [11] | Malfunctioning | Restriction: Only displayed if a malfunction occurs. See "8.1 To display the help text in case of a malfunction" [▶ 63] for more information. |
| [1] | Main zone | Shows the applicable symbol for your main zone emitter type. Set the leaving water temperature for the main zone. |
| [2] | Additional zone | Shows the applicable symbol for your additional zone emitter type. Set the leaving water temperature for the main zone. |
| [3] | Space heating/cooling | Shows the applicable symbol for your unit. Put the unit in heating mode or cooling mode. You cannot change the mode on heating only models. |
| [4] | Domestic hot water | Restriction: Only displayed if a domestic hot water tank is present. Set the domestic hot water tank temperature. |
| [5] | Settings | Settings for user and installer. Installer settings are only shown in the installer mode (the installer switch is in the position) |
| [6] | Information | Displays data and information about the indoor unit. |
| [7] | Maintenance mode | Restriction: Only for the installer. Perform tests and maintenance. |
| [8] | Connectivity | Restriction: Only for the installer. Gives access to advanced settings. |
| [9] | Energy | Shows the electricity consumption. |
| [10] | Configuration wizard | Restriction: Only for the installer. For setting the most important initial settings. |

| Submenu | | Description |
|---------|------------|--|
| [12] | ✚ Touch | Touchscreen options and testing. |
| [13] | ✂ Field IO | Restriction: Only for the installer. Terminal pin mapping for certain functions. |

Setpoint screen

The setpoint screen is displayed for screens describing system components that need a setpoint value.

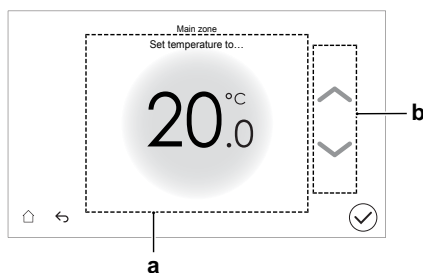

| Item | Description |
|----------|---|
| a | Desired temperature. Tap in the upper or lower area to increase/decrease the temperature. Note: As an alternative you can use the arrow area (b). |
| b | Tap the up/down arrows in this area to increase/decrease the temperature. |

5.1.3 Reading out information

To read out information

| | |
|----------|-------------------------|
| 1 | Go to [6]: Information. |
|----------|-------------------------|

Possible read-out information

| In menu... | You can read out... |
|--------------------------|--|
| [6.2] Dealer information | Contact/helpdesk number |
| [6.3] Sensors | Room, tank or domestic hot water, outside, and leaving water temperature (if applicable) |
| [6.4] Actuators | Status/mode of each actuator Example: Domestic hot water pump ON/OFF |
| [6.5] Operation modes | Current operation mode Example: Defrost/oil return mode |
| [6.6] About | Contains: <ul style="list-style-type: none"> ▪ Version information about the system ▪ Serial numbers ▪ Model name ▪ Build info |

5.1.4 Advanced user permission

The amount of information you can read and edit as a user in the menu structure depends on the following setting: **Advanced settings**.

When enabled, you can read and edit more information. Be careful because changes to advanced settings could lead to a less efficient, or even malfunctioning system.

To enable the Advanced settings

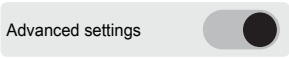
| | |
|----------|--|
| 1 | Go to [5.13] Settings > Advanced settings |
| 2 | Switch the Advanced settings ON:  |



5.2 Turning operation ON or OFF

Space heating/cooling operation

 **NOTICE**
Room frost protection. Even if you turn OFF space heating/cooling operation, room frost protection operation –if enabled– can still activate. However, for external room thermostat control, the protection is only active in case of a thermostat request.

 **NOTICE**
Water pipe freeze prevention. Even if you turn OFF space heating/cooling operation, water pipe freeze prevention –if enabled– will remain active.

In case you want to turn off ALL space heating/cooling:

| | |
|----------|---|
| 1 | Tap on the Spaces bar from the home screen. |
| 2 | Tap the  icon to turn climate control ON or OFF. |
| 3 | Confirm with the  button. Result: When OFF, the Space heating/cooling screen area on the home screen is greyed out. |

In case you only want to turn off an individual zone:

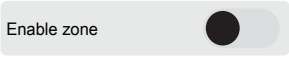
| | |
|----------|---|
| 1 | Restriction: Turning off an individual zone is only possible in case of LWT control. Tap on the emitter icon of a zone on the home screen, OR go to: <ul style="list-style-type: none"> ▪ [1.17] Main zone > Enable zone. ▪ [2.15] Additional zone > Enable zone. |
| 2 | Switch the zone OFF:  Result: When OFF, the zone screen area is greyed out. |

Tank heating operation





NOTICE

Disinfection mode. Even if you turn OFF tank heating operation, disinfection mode will remain active (if enabled).



NOTICE

It is recommended to set disinfection mode to once a day (setting [4.10] **Disinfection** > **Every day**).

| | |
|----------|--|
| 1 | Go to [4.1]: Domestic hot water > Single heat-up . Note: Tap on the Domestic hot water bar from the home screen to quickly access [4.1]. |
| 2 | Tap the  icon to turn Domestic hot water ON or OFF. |
| 3 | Confirm with the  button. Result: When OFF, the Domestic hot water screen area on the home screen is greyed out. |

5.3 Space heating/cooling control

5.3.1 About space heating/cooling control

Controlling space heating/cooling typically consists of the following stages:

- 1 Setting the space operation mode
- 2 Controlling the temperature

Depending on the system layout and installer configuration, you use a different temperature control:

- Room thermostat control
- Leaving water temperature control
- External room thermostat control

5.3.2 About room frost protection

Antifrost can be activated by setting [3.4].

In all cases, for the main and additional zone, **Antifrost** will heat the space heating water to a reduced setpoint when the outdoor temperature is lower than 6°C.

For the main zone: when [3.4] is enabled, antifrost prevents the room from getting below the [1.22] **Antifrost** setpoint. This setting is applicable when [1.12] **Control** = **Room**, but also offers functionality for leaving water temperature control and external room thermostat control.

Note: In all cases the antifrost can be activated via breadcrumb [3.4] (also for **Leaving water** or **External room thermostat** control).

Note: In case of thermostat cable breakdown, room frost protection cannot be guaranteed.

| [1.12] Main zone > Control | Description |
|----------------------------|---|
| Leaving water | Room frost protection is guaranteed via reduced leaving water temperature setpoint, in case the water zone is switched OFF. |
| External room thermostat | Room frost protection is guaranteed via reduced leaving water temperature setpoint when there is a thermostat request, in case the water zone is switched OFF. |
| Room (main zone only) | Allow for the dedicated Human Comfort Interface (BRC1HHDA used as room thermostat) to take care of room frost protection. Set the temperature of the antifrost function in [1.22] Antifrost . |

5.3.3 Setting the Operation mode

About space operation modes

Your unit is a heating/cooling model, it can both heat up and cool down a space. You have to tell the system which operation mode to use.

To tell the system which space operation to use, you can:

| You can... | Location |
|--|-------------|
| Check which space operation mode is currently used. | Home screen |
| Set the space operation mode permanently. | Main menu |
| Restrict automatic changeover according to a monthly schedule. | |

To check which space operation mode is currently used

The space operation mode is displayed on the home screen:

- When the unit is in heating mode, the ☀ icon is shown.
- When the unit is in cooling mode, the ❄ icon is shown.

The status indicator shows if the unit is currently in operation:

- When the unit is not in operation, the status indicator will show a blue pulsation with an interval of approximately 5 seconds.
- While the unit is in operation, the status indicator will light up blue constantly.

To set the space operation mode

| | |
|----------|--|
| 1 | Go to [3.2]: Space heating/cooling > Operation mode Note: Tap on the Spaces bar from the home screen for a quick access screen where the Operation mode can be selected. |
|----------|--|

- 2** Select one of the following options:
- **Heating:** Only heating mode
 - **Cooling:** Only cooling mode
 - **Automatic:** The operation mode changes automatically between heating and cooling based on the outdoor temperature. Restricted per month according to [3.5] **Operation mode schedule**.

In the automatic mode, the changeover depends on the outdoor temperatures set under [3.1] **Operation Range**. The difference between the two setpoints of [3.1] is used like a hysteresis in order to avoid frequent changeover.

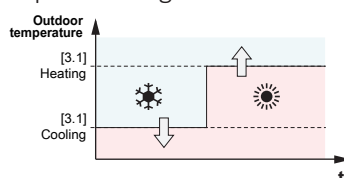

Note: If changeover occurs too frequent due to direct sunlight on the outdoor unit, the remote outdoor sensor (EKRS1A1) can be installed to improve the system behaviour.

Remark: The operation mode (heating or cooling) will be decided by the external room thermostat in case:

- there is only one zone (main zone),
- and the main zone is controlled by an external room thermostat,
- and the external room thermostat has individual heating/cooling signals (dual contacts).

To restrict automatic changeover according to a schedule

Conditions: You set the space operation mode to **Automatic**.

| | |
|----------|--|
| 1 | Go to [3.5]: Space heating/cooling > Operation mode schedule . |
| 2 | Select a month. |
| 3 | For each month, select an option: <ul style="list-style-type: none"> ▪ Automatic: Not restricted ▪ Heating: Restricted ▪ Cooling: Restricted |
| 4 | Confirm the changes. |

Example: Changeover restrictions

| When | Restriction |
|--|--------------|
| During cold season. Example: October, November, December, January, February and March. | Heating only |
| During warm season. Example: June, July and August. | Cooling only |
| In-between. Example: April, May and September. | Automatic |

5.3.4 Determining which temperature control you are using

To determine which temperature control you are using (method 1)

Check the installer settings table filled in by the installer.

To determine which temperature control you are using (method 2)

You can see on the home screen which temperature control you are using.

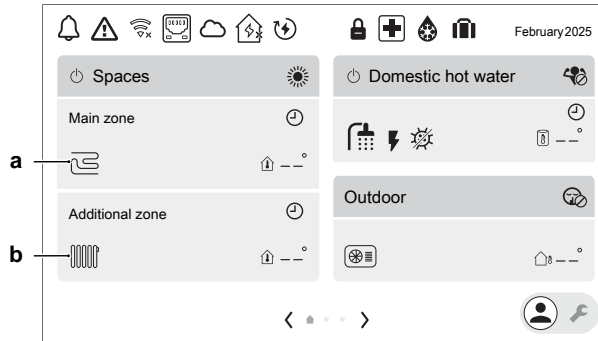

- a Heat emitter of the main zone (in this example **Under-floor heating**)
- b Heat emitter of the additional zone (in this example **Radiator**). If no icon is displayed, there is no additional zone.

5.3.5 Capacity shortage

Note: Only available in **Advanced settings** mode.

i **INFORMATION**

The backup heater logic determines whether to activate the backup heater when the heat pump experiences capacity shortage. The system will **ONLY** activate the backup heater when:

- The compressor is already running at its maximum capacity, and
- The leaving water temperature setpoint is **NOT** reached, and
- The leaving water temperature requested at the emitter is **NOT** reached in a fast enough rate.

Capacity shortage setting

This setting defines whether backup heater operation is allowed when the heat pump experiences capacity shortage.

| | |
|----------|--|
| 1 | Go to [5.6.1] Settings > Capacity shortage > Capacity shortage setting . |
| 2 | Choose one of the following options: <ul style="list-style-type: none"> ▪ Never: Never allow backup heater operation when the heat pump experiences capacity shortage. ▪ Always: Always allow backup heater operation when the heat pump experiences capacity shortage. ▪ Below equilibrium: Only allow backup heater operation when the heat pump experiences capacity shortage, and the outdoor temperature is below the equilibrium setpoint. |
| 3 | Confirm with the ✓ button. |

Equilibrium setpoint

The setting [5.6.2] **Equilibrium setpoint** defines the outdoor temperature below which backup heater operation is allowed when the heat pump experiences capacity shortage.

Restriction: Only applicable if [5.6.1] = **Below equilibrium**.

Adjust the equilibrium setpoint based on your building, location, and personal preference to ensure optimal balance and comfort.

| | |
|----------|--|
| 1 | Go to [5.6.2] Settings > Capacity shortage > Equilibrium setpoint . |
| 2 | Set the desired equilibrium setpoint. |
| 3 | Confirm with the ✓ button. |

5.3.6 Comfort setpoint for energy buffering

Defines the maximum or minimum setpoint that will be used when buffering the extra energy in the space heating/cooling circuit during heating or cooling operation.

| | |
|----------|---|
| 1 | Go to: <ul style="list-style-type: none"> ▪ [1.29] Main zone > Heating comfort setpoint. ▪ [1.30] Main zone > Cooling comfort setpoint. |
| 2 | Set the desired maximum/minimum comfort setpoint. |
| 3 | Confirm with the ✓ button. |

Restriction: Only applicable if:

- Smart Grid is enabled (installer setting)
- Room buffering is enabled (installer setting)
- Only shown when in **Advanced settings** mode.

5.3.7 Room sensor offset

Defines the offset that can be applied to the temperature reading of the room thermostat.

External room sensor offset

Restriction: Only applicable in case of room thermostat control.

Optional offset that can be applied to the room temperature target, measured by the optional sensor in the main zone.

| | |
|----------|--|
| 1 | Go to [1.33] Main zone > External room sensor offset . |
| 2 | Set the desired offset. |
| 3 | Confirm with the ✓ button. |

Thermostat sensor offset

Restriction: Only applicable in case of room thermostat control.

Offset on the room temperature on the Human Comfort Interface in the main zone.

| | |
|----------|---|
| 1 | Go to [1.38] Main zone > Thermostat sensor offset . |
| 2 | Set the desired offset. |

| | |
|----------|----------------------------|
| 3 | Confirm with the ✓ button. |
|----------|----------------------------|

5.3.8 To set the Operation Range

Set the value of average outdoor temperature above/below which the operation of the unit in space heating/cooling is prohibited.

| | |
|----------|--|
| 1 | Go to [3.1]: Space heating/cooling > Operation Range |
| 2 | Set the values for heating and cooling using the sliders: <ul style="list-style-type: none"> ▪ Space heating: When the averaged outdoor temperature rises above this value, space heating is turned OFF.^(a) ▪ Space cooling: When the averaged outdoor temperature drops below this value, space cooling is turned OFF.^(a) |
| 3 | Confirm with the ✓ button. |

^(a) This setting is also used in automatic heating/cooling changeover.

5.3.9 To set the Emitter type

The **Emitter type** MUST match your system layout.

| | |
|----------|---|
| 1 | Go to: <ul style="list-style-type: none"> ▪ [1.11] Main zone > Emitter type. ▪ [2.11] Additional zone > Emitter type. |
| 2 | Set the correct type for the relevant zone: <ul style="list-style-type: none"> ▪ Under floor heating ▪ Heat pump convector ▪ Radiator |
| 3 | Confirm with the ✓ button. |

5.3.10 To change the desired room temperature

During room temperature control, you can use the room temperature setpoint screen to read out and adjust the desired room temperature.

| | |
|----------|--|
| 1 | Go to [1.1] Main zone > Room setpoint. Note: From the home screen, tap on the main zone temperature screen area to quickly access [1.1]. |
| 2 | Adjust the desired room temperature:  |
| 3 | Confirm with the ✓ button. |

If scheduling is on after changing the desired room temperature

- The temperature will stay the same as long as there is no scheduled action.
- The desired room temperature will return to its scheduled value whenever a scheduled action occurs.

You can avoid scheduled behaviour by (temporarily) turning off scheduling. See "5.3.13 To enable scheduling" [▶ 32].

5.3.11 To set the room **Hysteresis**

ONLY applicable in case of room thermostat control. The hysteresis band around the desired room temperature can be adjusted. It is recommended NOT to change the room temperature hysteresis as it is set for optimal use of the system.

| | |
|----------|--|
| 1 | Go to [1.10] Main zone > Hysteresis |
| 2 | Adjust the hysteresis value. Note: The range for hysteresis is 0.5~10°C. |
| 3 | Confirm with the ✓ button. |

Examples:

Room heating target is 20°C, hysteresis is 0.5°C → heating stops at 20.5°C and starts at 19.5°C.

Room cooling target is 18°C, hysteresis is 0.5°C → cooling stops at 17.5°C and starts at 18.5°C.

5.3.12 To change the desired leaving water temperature



INFORMATION

The leaving water is the water that is sent to the heat emitters. The desired leaving water temperature is set by your installer in accordance with the heat emitter type. Only adjust the leaving water temperature settings in case of problems.

In case no weather-dependent curve is used

You can adjust the fixed leaving water temperature as follows:

| | |
|----------|---|
| 1 | Go to: <ul style="list-style-type: none"> ▪ [1.39] Main zone > Leaving water temp ▪ [2.30] Additional zone > Leaving water temp Note: From the home screen, tap on the main (or additional) zone temperature screen area to quickly access [1.39] (or [2.30]). Note: In case of weather dependent mode, LWT is not controlled by this setting. |
| 2 | Adjust the desired leaving water temperature: <div style="text-align: center;"> </div> |
| 3 | Confirm with the ✓ button. |

In case weather-dependent curve is used

Note: For more information on weather-dependent operation, see "[5.6 Weather-dependent curve](#)" [▶ 47].

You can set a temperature shift to the weather-dependent curve leaving water temperature as follows:

| | |
|----------|---|
| 1 | Go to: <ul style="list-style-type: none"> ▪ [1.27] Main zone > Leaving water shift heating ▪ [1.28] Main zone > Leaving water shift cooling ▪ [2.22] Additional zone > Leaving water shift heating ▪ [2.23] Additional zone > Leaving water shift cooling |
| 2 | Adjust the desired leaving water shift temperature. Note: The temperature shift value can be set in 1°C increments. |
| 3 | Confirm with the ✓ button. |

If scheduling is on after changing the desired leaving water temperature

- The temperature will stay the same as long as there is no scheduled action.
- The desired leaving water temperature will return to its scheduled value whenever a scheduled action occurs.

You can avoid scheduled behaviour by (temporarily) turning off scheduling. See "5.3.13 To enable scheduling" [▶ 32].

To enable weather-dependent operation for the leaving water temperature

See "5.6.2 Using weather-dependent curves" [▶ 48].

5.3.13 To enable scheduling

To enable heating scheduling

| | |
|----------|---|
| 1 | Go to: <ul style="list-style-type: none"> ▪ [1.2] Main zone > Heating schedule enable ▪ [2.2] Additional zone > Heating schedule enable |
| 2 | Switch scheduling ON (or OFF): <div style="border: 1px solid #ccc; padding: 2px; display: inline-block;"> Heating schedule enable <input checked="" type="checkbox"/> </div> |

To enable cooling scheduling

| | |
|----------|---|
| 1 | Go to: <ul style="list-style-type: none"> ▪ [1.23] Main zone > Cooling schedule enable ▪ [2.27] Additional zone > Cooling schedule enable |
| 2 | Switch scheduling ON (or OFF): <div style="border: 1px solid #ccc; padding: 2px; display: inline-block;"> Cooling schedule enable <input checked="" type="checkbox"/> </div> |

5.3.14 To change the Zone name

You can assign a custom name to each zone using the following settings:

- [1.21] Main zone > Zone name
- [2.21] Additional zone > Zone name

5.4 Domestic hot water control

5.4.1 About domestic hot water control

Depending on the DHW tank heat up mode (installer setting), you use a different domestic hot water control:

- Reheat
- Scheduled
- Schedule and reheat

To determine which DHW heat up mode you are using (method 1)

Check the installer settings table filled in by the installer.

To determine which DHW heat up mode you are using (method 2)

| | |
|----------|--|
| 1 | Go to [4.7] Domestic hot water > Heat up mode. |
| 2 | Check which setting is displayed: <ul style="list-style-type: none"> ▪ Reheat ▪ Scheduled ▪ Schedule and reheat |

5.4.2 Reheat mode

In **Reheat** mode, the DHW tank continuously heats up to the temperature shown on the home screen (example: 45°C) when the temperature drops below a certain value.

Heat-up of the DHW tank is controlled by two triggers:

1 [4.12] Hysteresis:

This trigger compensates for natural heat losses and intermittent DHW usage. The system continuously monitors for heat loss, and when the tank temperature drops below "[4.5] Reheat setpoint – [4.12] Hysteresis", it starts determining when reheating is necessary.

This trigger ensures that the system maintains sufficient hot water availability before temperatures fall too low for user demand.

2 [4.19] Reheat Trigger Threshold:

Only applicable for DHW consumption (rapid decrease of temperature). The tank heats up when the temperature drops below a predefined value. The threshold is set with sufficient spare capacity to prevent an immediate shortage of hot water for the end user.

It ensures that the system maintains a reliable supply while avoiding unnecessary reheating cycles.

Note: Only available in **Advanced settings** mode.

Note: Always make sure to use a value lower than [4.5] Reheat setpoint.

By using these two triggers, the system efficiently balances energy consumption while ensuring a reliable supply of hot water when needed.

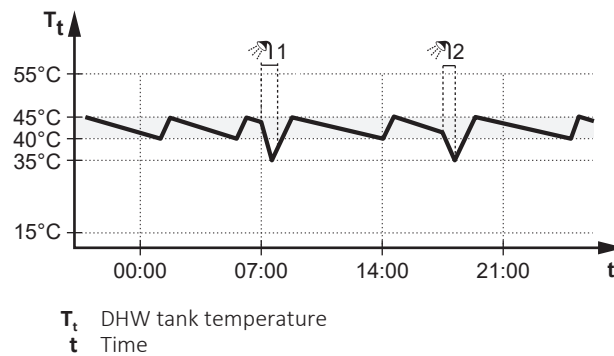
Example:**INFORMATION**

Risk of space heating capacity shortage for domestic hot water tank without internal booster heater: In case of frequent domestic hot water operation, frequent and long space heating/cooling interruption will happen when selecting **Operation mode = Reheat** (only reheat operation allowed for the tank).

To set the DHW Reheat mode

| | |
|----------|--|
| 1 | Go to [4.7] Domestic hot water > Heat up mode. |
| 2 | Set Heat up mode to Reheat. |

To change the tank temperature setpoint

In **Reheat** and **Schedule and reheat** mode, you can use the tank temperature setpoint screen to adjust the domestic hot water temperature.

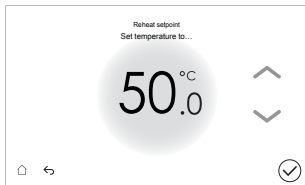
| | |
|----------|---|
| 1 | Go to [4.5]: Domestic hot water > Reheat setpoint. |
| 2 | Adjust the domestic hot water temperature:  |

5.4.3 Schedule and reheat mode

In **Schedule and reheat** mode, the domestic hot water control is the same as in scheduled mode. However, when the DHW tank temperature drops below a value, the DHW tank heats up until it reaches the reheat setpoint (example: 45°C). This ensures that a minimum amount of hot water is available at all times.

See "[5.5.2 Schedule screen: Example](#)" [▶ 43] for an example how to set up a schedule.

For **Schedule and reheat**, the heat-up of the DHW tank is controlled by three triggers:

1 [4.6] Single heat-up schedule:

The tank heats up according to the time and temperature as scheduled.

2 [4.12] Hysteresis:

This trigger compensates for natural heat losses and intermittent DHW usage. The system continuously monitors for heat loss, and when the tank temperature drops below "[4.5] Reheat setpoint – [4.12] Hysteresis", it starts determining when reheating is necessary.

This trigger ensures that the system maintains sufficient hot water availability before temperatures fall too low for user demand.

3 [4.19] Reheat Trigger Threshold:

Only applicable for DHW consumption (rapid decrease of temperature). The tank heats up when the temperature drops below a predefined value. The threshold is set with sufficient spare capacity to prevent an immediate shortage of hot water for the end user.

It ensures that the system maintains a reliable supply while avoiding unnecessary reheating cycles.

Note: Only available in **Advanced settings** mode.

Note: Always make sure to use a value lower than [4.5] Reheat setpoint.

By using these three triggers, the system efficiently balances energy consumption while ensuring a reliable supply of hot water when needed.

Example:

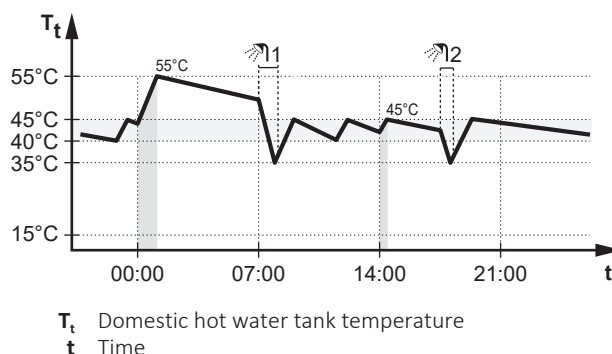

To set up a schedule

See "5.5.2 Schedule screen: Example" [▶ 43] for an example how to set up a schedule.

To set the Schedule and reheat mode

| | |
|----------|--|
| 1 | Go to [4.7] Domestic hot water > Heat up mode. |
| 2 | Set Heat up mode to Schedule and reheat. |

To change the tank temperature setpoint

In **Reheat** and **Schedule and reheat** mode, you can use the tank temperature setpoint screen to adjust the domestic hot water temperature.

| | |
|----------|--|
| 1 | Go to [4.5]: Domestic hot water > Reheat setpoint. |
|----------|--|

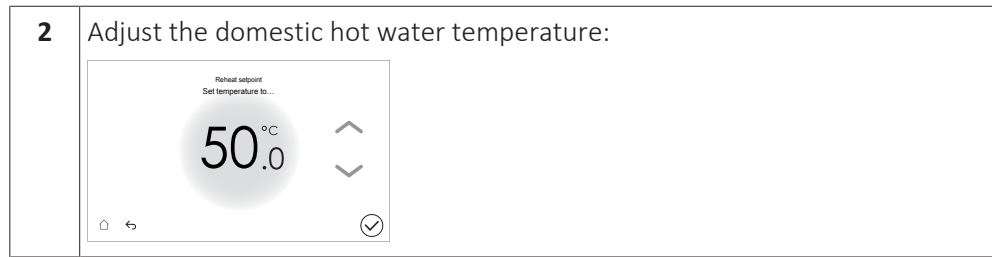

Note: In **Schedule** and **reheat** mode, the **Reheat setpoint** is used in between the scheduled heat-ups (to the temperature that is set in the schedule).

5.4.4 Scheduled mode

In **Scheduled** mode, the DHW tank produces hot water corresponding to a schedule.

For **Scheduled**, the heat-up of the DHW tank is triggered by [4.6] **Single heat-up schedule**. The tank heats up according to the time and temperature as scheduled.

Example:

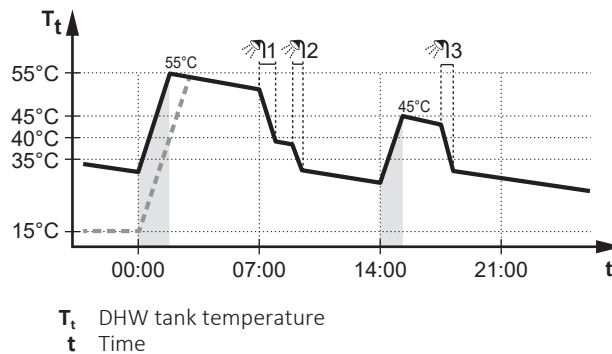

- Initially, the DHW tank temperature is the same as the temperature of the domestic water entering the DHW tank (example: **15°C**).
- At 00:00 the DHW tank is programmed to heat up the water to **55°C**.
- During the morning, you consume hot water and the DHW tank temperature decreases.
- At 14:00 the DHW tank is programmed to heat up the water to **45°C**. Hot water is available again.
- During the afternoon and evening, you consume hot water again and the DHW tank temperature decreases again.
- At 00:00 the next day, the cycle repeats.

To set up a schedule

See "5.5.2 Schedule screen: Example" [▶ 43] for an example how to set up a schedule.

To set the DHW Scheduled mode

| | |
|----------|---|
| 1 | Go to [4.7] Domestic hot water > Heat up mode . |
| 2 | Set Heat up mode to Scheduled . |

5.4.5 Single heat-up

Single heat-up immediately starts heating up the DHW tank using one of the following two modes:

- Manual
- Powerful operation

Manual mode

The tank heats up in an efficient way.

Powerful operation mode

The tank heats up using the backup heater or booster heater. For more information, see "[Powerful heating mode](#)" [▶ 37].

Powerful heating mode

About Powerful heating

Powerful heating immediately starts the domestic hot water heat-up using the backup heater or booster heater.



Use this mode on days when there is more hot water usage than usual, and more hot water is needed quickly.

The **Powerful heating** mode will consume more energy than the **Manual** mode.

To check if Powerful heating is active

If  is displayed on the home screen, **Powerful heating** is active.

Activate or deactivate **Powerful heating** as follows:

| | |
|----------|--|
| 1 | Go to [4.1] Domestic hot water > Single heat-up . Note: Tap on the Domestic hot water bar from the home screen to quickly access [4.1]. |
| 2 | Turn Single heat-up ON using the  button, and select Powerful heating . |
| 3 | Confirm with the  button. |

Or alternatively:

| | |
|----------|--|
| 1 | Go to [4.4] Powerful operation setpoint . |
| 2 | Press the Start button to activate the heat-up process. |

Note: To stop an ongoing heat-up process, tap on the **Domestic hot water** bar from the home screen and press the  button.

Usage example: You immediately need more hot water

You are in the following situation:

- You already consumed most of your domestic hot water.
- You cannot wait for the next scheduled action to heat up the domestic hot water tank.

Then you can activate powerful operation. The domestic hot water tank will start heating up the water to the **Powerful operation setpoint** temperature.



INFORMATION

When powerful operation is active, the risk of space heating/cooling and capacity shortage comfort problems is significant. In case of frequent domestic hot water operation, frequent and long space heating/cooling interruptions will happen.

Manual mode

About Manual mode



Manual immediately starts the domestic hot water heat-up, but in a more efficient way than the **Powerful heating**.

Use this mode on days when there is more hot water usage than usual, and more hot water is needed in an efficient way. **Manual** heat-up can take longer than using **Powerful heating**.

To check if Manual heat-up is active

If  is displayed on the home screen, DHW tank heat-up is ongoing. However, to see if **Manual** operation is active, you can follow the activate/deactivate steps as described below.

Activate or deactivate **Manual** as follows:

| | |
|----------|--|
| 1 | Go to [4.1] Domestic hot water > Single heat-up . Note: Tap on the Domestic hot water bar from the home screen to quickly access [4.1]. |
| 2 | Turn Single heat-up ON using the  button, and select Manual . |
| 3 | Confirm with the  . |

Or alternatively:

| | |
|----------|--|
| 1 | Go to [4.3] Manual setpoint . |
| 2 | Press the Start button to activate the heat-up process. |

Note: To stop an ongoing heat-up process, tap on the **Domestic hot water** bar from the home screen and press the .

5.4.6 Additional heat source for DHW

Additional heat source take-over during space heating/cooling

When this setting is enabled, the booster heater will be used for tank heat-up if the unit is balancing between space heating/cooling and tank heat-up.

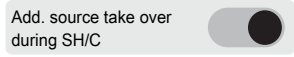
| | |
|----------|--|
| 1 | Go to [4.16] Domestic hot water > Add. source take over during SH/C |
| 2 | Switch Add. source take over during SH/C ON:  |

Note: Default setting is OFF.

Note: When ON, energy consumption can be higher.

Additional heat source DHW always on request

When this setting is enabled, the booster heater will be used together with the heat pump during a tank heat-up, even when the unit is not balancing between space heating/cooling and tank heat-up.

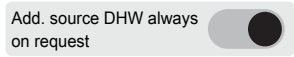
| | |
|----------|--|
| 1 | Go to [4.17] Domestic hot water > Add. source DHW always on request |
| 2 | Switch Add. source DHW always on request ON:  |

Note: Default setting is OFF.

Note: When ON, energy consumption will be higher.

5.5 Schedules

5.5.1 Using and programming schedules

About schedules

Depending on your system layout and installer configuration, schedules for multiple controls may be available.

| You can... | See... |
|---|---|
| Set if a specific control needs to act according to a schedule. | " Activation screen " in " Possible schedules " [▶ 40] |
| Select which schedule you currently want to use for a specific control. The system contains some predefined schedules. You can: | |
| Consult which schedule is currently selected. | " Schedule/Control " in " Possible schedules " [▶ 40] |
| Select another schedule if needed. | " To select which schedule you currently want to use " [▶ 39] |
| Program your own schedules if the predefined schedules are not satisfactory. The actions you can program are control specific. | <ul style="list-style-type: none"> ▪ "Possible actions" in "Possible schedules" [▶ 40] ▪ "5.5.2 Schedule screen: Example" [▶ 43] |

To select which schedule you currently want to use

Go to the schedule for the specific control.

See "**Schedule/Control**" in "**Possible schedules**" [▶ 40].

Example:

- [1.3] Main zone > Heating schedule.
- [1.4] Main zone > Cooling schedule

Select the schedule that you currently want to use.

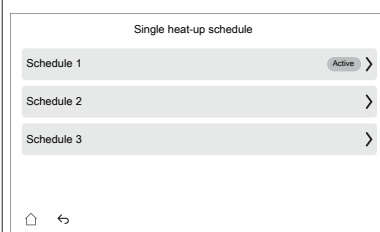

Tap the **Activate** button.

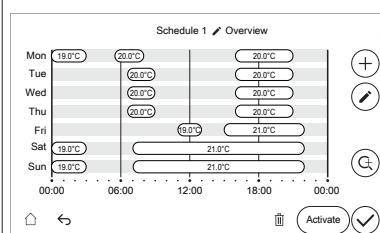

Confirm with the **✓** button.

Possible schedules

The table contains the following information:

- **Schedule/Control:** This column shows you where you can consult the currently selected schedule for the specific control. If needed, you can:
 - Select another schedule. See ["To select which schedule you currently want to use"](#) [▶ 39].
 - Program your own schedule. See ["5.5.2 Schedule screen: Example"](#) [▶ 43].
- **Predefined schedules:** Number of available predefined schedules in the system for the specific control. If needed, you can program your own schedule.
- **Activation screen:** For most controls, a schedule is only effective if it activated in its corresponding activation screen. This entry shows you where to activate it.
- **Possible actions:** Actions you can use when programming a schedule.

| Schedule/Control | Description |
|--|---|
| [1.3] Main zone > Heating schedule | <p>Predefined schedules: 3</p> <p>Activation: [1.2] Heating schedule enable</p> <p>Possible actions: Temperatures within range</p> <p>Restriction: Not for external room thermostat control.</p> <p>Schedule for the main zone in heating mode to set the desired leaving water or room temperature (depending on the installed system).</p> <p>Note: In case of room temperature scheduling, the baseline temperature will be used at times when no temperature is scheduled (i.e. in between the schedule blocks). To set the baseline temperature, go to [1.34] Main zone > Heating target baseline</p> <p>Note: In case of LWT scheduling, operation will be OFF when no temperature is scheduled.</p> |
| [1.4] Main zone > Cooling schedule Schedule for the main zone in cooling mode to set the desired leaving water or room temperature (depending on the installed system). | <p>Predefined schedules: 1</p> <p>Activation: [1.23] Cooling schedule enable</p> <p>Possible actions: Temperatures within range</p> <p>Restriction: Not for external room thermostat control.</p> <p>Note: In case of room temperature scheduling, the baseline temperature will be used at times when no temperature is scheduled (i.e. in between the schedule blocks). To set the baseline temperature, go to [1.35] Main zone > Cooling target baseline</p> <p>Note: In case of LWT scheduling, operation will be OFF when no temperature is scheduled.</p> |

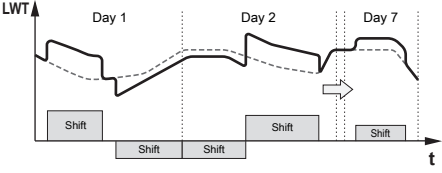
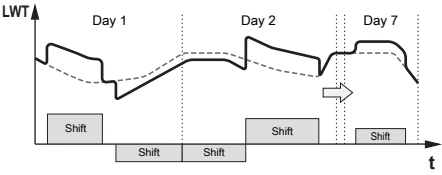
| Schedule/Control | Description |
|--|--|
| <p>[2.3] Additional zone > Heating schedule</p> <p>Schedule for the additional zone in heating mode to set the desired leaving water temperature.</p> | <p>Predefined schedules: 1</p> <p>Activation: [2.2] Heating schedule enable</p> <p>Possible actions: Leaving water temperatures within range</p> <p>Restriction: Only for LWT control.</p> |
| <p>[2.4] Additional zone > Cooling schedule</p> <p>Schedule for the additional zone in cooling mode to set the desired leaving water temperature.</p> | <p>Predefined schedules: 1</p> <p>Activation: [2.27] Cooling schedule enable</p> <p>Possible actions: Leaving water temperatures within range</p> <p>Restriction: Only for LWT control.</p> |
| <p>[1.24] Main zone > Leaving water shift heating schedule</p> | <p>Predefined schedules: 1</p> <p>Activation: [1.36] Leaving water shift heating mode</p> <p>Possible actions: Leaving water shift temperatures on the weather dependent curve.</p> <p>Note: Only in case weather-dependent curve is used (see "5.6 Weather-dependent curve" [▶ 47]) and only for LWT control.</p> <p>Remark: In case of LWT shift scheduling, there will be NO operation at times when no temperature is scheduled.</p> <p>Example:</p>  |
| <p>[1.25] Main zone > Leaving water shift cooling schedule</p> | <p>Predefined schedules: 1</p> <p>Activation: [1.37] Leaving water shift cooling mode</p> <p>Possible actions: Leaving water shift temperatures on the weather dependent curve.</p> <p>Note: Only in case weather-dependent curve is used (see "5.6 Weather-dependent curve" [▶ 47]) and only for LWT control.</p> <p>Remark: In case of LWT shift scheduling, there will be NO operation at times when no temperature is scheduled.</p> <p>Example:</p>  |

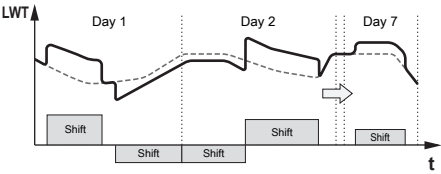
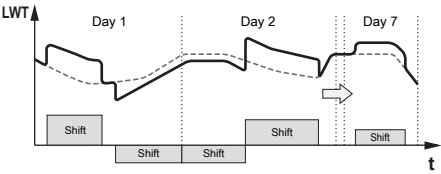
| Schedule/Control | Description |
|--|--|
| <p>[2.18] Additional zone > Leaving water shift heating schedule</p> | <p>Predefined schedules: 1</p> <p>Activation: [2.31] Leaving water shift heating mode</p> <p>Possible actions: Leaving water shift temperatures on the weather-dependent curve.</p> <p>Note: Only in case weather-dependent curve is used (see "5.6 Weather-dependent curve" [▶ 47]) and only for LWT control.</p> <p>Remark: In case of LWT shift scheduling, there will be NO operation at times when no temperature is scheduled.</p> <p>Example:</p>  |
| <p>[2.19] Additional zone > Leaving water shift cooling schedule</p> | <p>Predefined schedules: 1</p> <p>Activation: [2.32] Leaving water shift cooling mode</p> <p>Possible actions: Leaving water shift temperatures on the weather-dependent curve.</p> <p>Note: Only in case weather-dependent curve is used (see "5.6 Weather-dependent curve" [▶ 47]) and only for LWT control.</p> <p>Remark: In case of LWT shift scheduling, there will be NO operation at times when no temperature is scheduled.</p> <p>Example:</p>  |
| <p>[3.5] Space heating/cooling > Operation mode schedule</p> <p>Schedule (per month) for when to operate the unit in heating mode and when in cooling mode.</p> | <p>See "To set the space operation mode" [▶ 26].</p> |

| Schedule/Control | Description |
|--|--|
| <p>[4.6] Domestic hot water > Single heat-up schedule</p> <p>Schedule for the domestic hot water tank temperature for your normal domestic hot water needs.</p> | <p>Predefined schedules: 1</p> <p>Activation: Not applicable. This schedule is automatically activated if [4.7] Heat up mode is one of the two following settings:</p> <ul style="list-style-type: none"> ▪ Schedule only ▪ Schedule and reheat <p>Note: In Schedule and reheat mode, the tank also heats up according to the [4.5] Reheat setpoint.</p> |
| <p>[4.26] Domestic hot water > DHW pump schedule</p> <p>Schedule for the DHW pump for instant hot water (if installed).</p> | <p>Program a schedule for the DHW pump.</p> <p>Program a domestic hot water pump schedule to determine when to turn on and off the pump.</p> <p>When turned on, the pump runs and makes sure hot water is instantly available at the tap. To save energy, only turn on the pump during periods of the day when instant hot water is necessary.</p> |
| <p>[5.2.2] Settings > Quiet operation > Schedule</p> <p>OR from the home screen: tap on the Outdoor bar, and tap on Schedule.</p> <p>Schedule for when the unit has to use which quiet mode level.</p> | <p>Predefined schedules: 1</p> <p>Activation: To activate, choose the option Scheduled and confirm.</p> <p>See "To program a quiet mode schedule" [▶ 56].</p> |
| <p>[9.4] User settings > Electricity price schedule</p> <p>Schedule for when a certain electricity tariff is valid.</p> | <p>Predefined schedules: 1</p> <p>Activation: [9.3] Electricity price schedule enable</p> <p>Possible actions: You can enter the price per kWh.</p> <p>See "5.7 Energy prices" [▶ 50].</p> |

5.5.2 Schedule screen: Example

This example shows how to set a room temperature schedule in heating mode for the main zone.



INFORMATION

The procedures to program other schedules are similar.

To program the schedule: overview

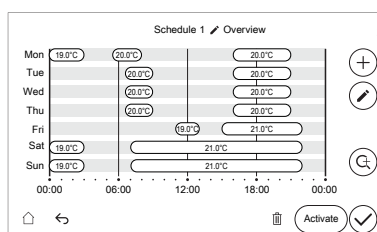

Prerequisite: Room temperature scheduling is only possible if room thermostat control is active. If LWT control is active, the schedule applies to the LWT instead.

Prerequisite: Scheduling is not possible when using an external room thermostat.



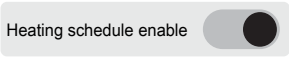

- 1 Go to the schedule.
- 2 (optional) Clear the content of the whole week schedule or the content of a selected day schedule.
- 3 Program the schedule for the weekdays.
- 4 Program the schedule for the weekend.
- 5 Give the schedule a name.

Note: You can set one time block for multiple days by selecting any day, workweek, weekend or every day.

To go to the schedule

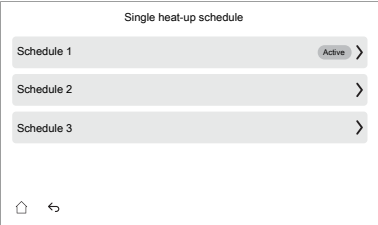

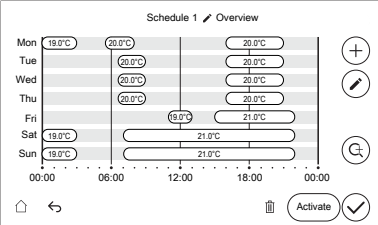
| | |
|----------|--|
| 1 | Go to [1.2] Main zone > Heating schedule. |
| 2 | Switch scheduling ON:  |
| 3 | Go to [1.3] Main zone > Heating schedule. |

To clear the content of the week schedule

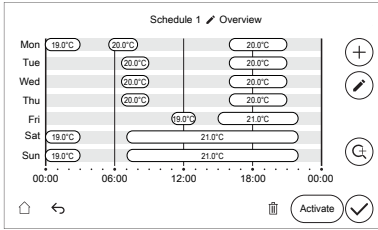
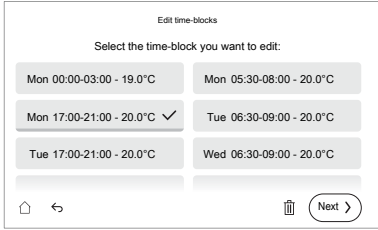

| | |
|----------|---|
| 1 | Go to the schedule you want to clear:  |
| 2 | Tap the  button to delete the schedule:  |
| 3 | Confirm with the  button. |

To clear the content of a time block in a schedule

| | |
|----------|---|
| 1 | Go to the schedule you want to edit.  |
|----------|---|

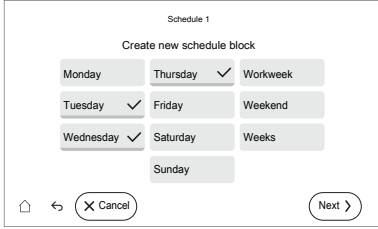
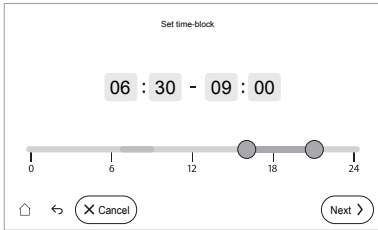

| | |
|---|--|
| 2 | <p>Tap the  button to edit the time blocks of the schedule:</p>  |
| 3 | <p>Select the time block you want to clear:</p>  |
| 4 | <p>Tap the  button to clear the time block.</p> |
| 5 | <p>Confirm with the  button.</p> |

To add time blocks

| | |
|---|--|
| 1 | <p>Tap the  button to add a time block.</p> |
| 2 | <p>Select one or more days for the time block to apply to:</p>  |
| 3 | <p>Tap the Next button.</p> |
| 4 | <p>Set the first schedule starting and ending time for the time block:</p>  <ul style="list-style-type: none"> ▪ Change the time entries directly by swiping up/down or tapping the +/- signs. ▪ OR use the bar, by dragging the starting time point and ending time point. |
| 5 | <p>Tap the Next button.</p> |
| 6 | <p>Set the desired temperature.</p> |
| 7 | <p>Confirm with the  button.</p> |

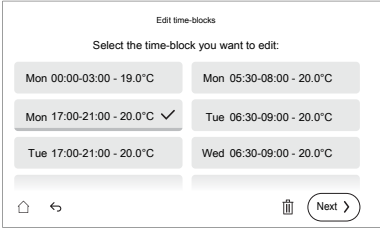
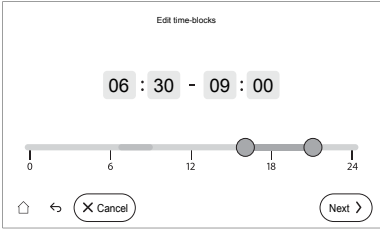

| | |
|----------|---|
| 8 | <p>Add more time blocks if needed.</p> <p>Note: In case of room temperature scheduling, the baseline temperature will be used at times when no temperature is scheduled. To set the baseline temperature, go to:</p> <ul style="list-style-type: none"> ▪ [1.34] Main zone > Heating target baseline ▪ [1.35] Main zone > Cooling target baseline <p>Remark: In case of LWT scheduling and LWT shift scheduling, there will be NO operation at times when no temperature is scheduled.</p> |
|----------|---|

To edit a time block

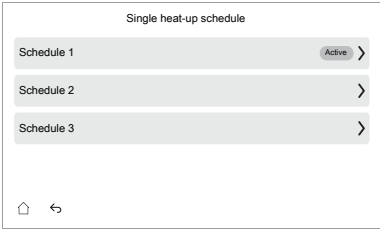

| | |
|----------|--|
| 1 | Tap the  button to edit a time block. |
| 2 | <p>Select the time block you want to edit:</p>  |
| 3 | Tap the Next button. |
| 4 | <p>Set the first schedule starting and ending time for the time block:</p>  <ul style="list-style-type: none"> ▪ Change the time entries directly by swiping up/down or tapping the +/- signs. ▪ OR use the bar, by dragging the starting time point and ending time point. |
| 5 | Tap the Next button. |
| 6 | Set the desired temperature. |
| 7 | Confirm with the  button. |

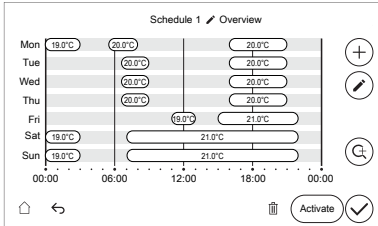
To rename a schedule

| | |
|----------|---|
| 1 | <p>Go to the schedule you want to rename:</p>  |
|----------|---|

| | |
|---|---|
| 2 | <p>Tap the  icon next to the schedule name to rename the schedule:</p>  |
| 3 | Rename the schedule using the on-screen keyboard. |
| 4 | Confirm with the  button. |

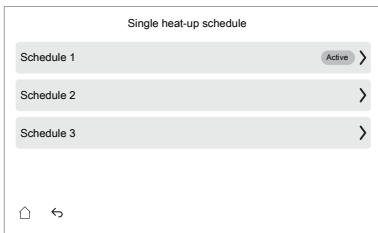
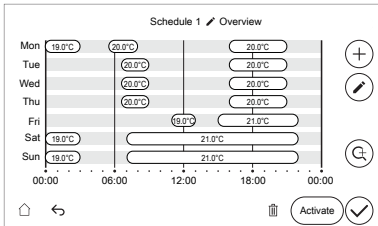
To activate a schedule

| | |
|---|---|
| 1 | <p>Select the schedule:</p>  |
| 2 | <p>Tap the Activate button:</p>  <p>Note: In the schedule overview, the active schedule will be marked with 'Active'.</p> |
| 4 | Confirm with the  button. |

Usage example: You work in a 3-shift system

If you work in a 3-shift system, you can do the following:

- 1 Program 3 room temperature schedules and give them appropriate names.
Example: EarlyShift, DayShift and LateShift
- 2 Select the schedule that you currently want to use.

5.6 Weather-dependent curve

5.6.1 What is a weather-dependent curve?

Weather-dependent operation

The unit operates 'weather-dependent' if the desired leaving water temperature is determined automatically by the outdoor temperature. It therefore is connected to a temperature sensor on the North wall of the building. If the outdoor temperature drops or rises, the unit compensates instantly. Thus, the unit does not have to wait for feedback by the thermostat to increase or decrease the temperature of the leaving water. Because it reacts more quickly, it prevents high rises and drops of the indoor temperature and water temperature at tap points.

Advantage

Weather-dependent operation reduces energy consumption.

Weather-dependent curve

To be able to compensate for differences in temperature, the unit relies on its weather-dependent curve. This curve defines how much the temperature of the leaving water must be at different outdoor temperatures. Because the slope of the curve depends on local circumstances such as climate and the insulation of the building, the curve can be adjusted by an installer or user.

Type of weather-dependent curve

The type of weather-dependent curve is "2-points curve".

Availability

The weather-dependent curve is available for:

- Main zone - Heating
- Main zone - Cooling
- Additional zone - Heating
- Additional zone - Cooling

5.6.2 Using weather-dependent curves

Related screens

The following table describes:

- Where you can define the different weather-dependent curves
- When the curve is used (restriction)

| To define the curve, go to... | Curve is used when... |
|--|---|
| [1.8] Main zone > Heating WD curve | [1.5] Heating setpoint mode = Weather dependent |
| [1.9] Main zone > Cooling WD curve | [1.7] Cooling setpoint mode = Weather dependent |
| [2.8] Additional zone > Heating WD curve | [2.5] Heating setpoint mode = Weather dependent |
| [2.9] Additional zone > Cooling WD curve | [2.7] Cooling setpoint mode = Weather dependent |



INFORMATION

Maximum and minimum setpoints

You cannot configure the curve with temperatures that are higher or lower than the set maximum and minimum setpoints for that zone. When the maximum or minimum setpoint is reached, the curve flattens out.

To define a weather-dependent curve

Define the weather-dependent curve using two setpoints (**b**, **c**). **Example:**

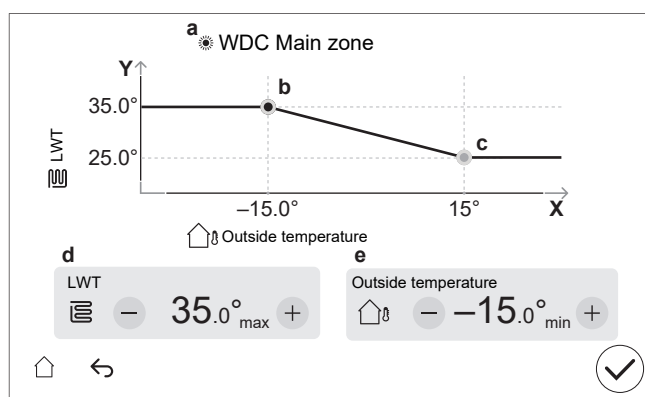

| Item | Description |
|---------------|--|
| a | Selected weather-dependent curve: <ul style="list-style-type: none"> ▪ [1.8] Main zone – Heating (☀) ▪ [1.9] Main zone – Cooling (❄) ▪ [2.8] Additional zone – Heating (☀) ▪ [2.9] Additional zone – Cooling (❄) |
| b, c | Setpoint 1 and setpoint 2. You can change them: <ul style="list-style-type: none"> ▪ By dragging the setpoint. ▪ By tapping the setpoint, and then using the – / + buttons in e, f. |
| d, e | Values of the selected setpoint. You can change the values using the – / + buttons. |
| X-axis | Outdoor temperature. |
| Y-axis | Leaving water temperature for the selected zone. The icon corresponds to the heat emitter for that zone: <ul style="list-style-type: none"> ▪ : Underfloor heating ▪ : Fan coil unit ▪ : Radiator |

To fine-tune a weather-dependent curve

The following table describes how to fine-tune the weather-dependent curve of a zone:

| You feel... | | Fine-tune with setpoints: | | | |
|-------------------------------------|----------------------------------|---------------------------|---|----------------|---|
| At regular outdoor temperatures ... | At cold outdoor temperatures ... | Setpoint 1 (b) | | Setpoint 2 (c) | |
| | | X | Y | X | Y |
| OK | Cold | ↑ | ↑ | — | — |
| OK | Hot | ↓ | ↓ | — | — |
| Cold | OK | — | — | ↑ | ↑ |
| Cold | Cold | ↑ | ↑ | ↑ | ↑ |
| Cold | Hot | ↓ | ↓ | ↑ | ↑ |
| Hot | OK | — | — | ↓ | ↓ |
| Hot | Cold | ↑ | ↑ | ↓ | ↓ |
| Hot | Hot | ↓ | ↓ | ↓ | ↓ |

5.7 Energy prices

In the system, you can set the following energy prices:

- a fixed gas price (only shown in case bivalent or tank boiler is present)
- three electricity price levels
- a weekly schedule timer for electricity prices.

Example: How to set the energy prices on the user interface?

| Price | Value in breadcrumb |
|--------------------------------|---------------------|
| Gas: 5.3 euro cents/kWh | [9.5]=5.3 |
| Electricity: 12 euro cents/kWh | [9.1]=12 |

5.7.1 Energy price considered

About the setting

Restriction: The [9.13] **Energy price considered** setting is only shown in case bivalent or tank boiler is present.

If an external heat source is available, the main heat source will be chosen based on a comparison between both efficiencies of the heat sources.

The decision on which source to select depends on the setting [9.13] **Energy price considered**. This setting defines if the energy prices are considered or not.

- **When considered**, the main heat source will be decided based on the bivalent changeover condition decided by the energy prices with dedicated ambient boundaries selected by the installer
- **When NOT considered**, the main heat source will be decided based on the ambient boundaries selected by the installer without taking into account the energy prices. This case is mainly capacity driven, where below the selected boundaries, the boiler will cover the space heating.

See the Installer reference guide for more information.

To go to [9.13] Energy price considered

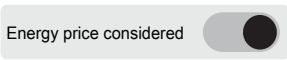
| | |
|----------|--|
| 1 | Go to [9.13] Energy > Energy price considered . |
| 2 | Switch the setting ON or OFF:  |

5.7.2 To set the fixed electricity price (no scheduling)

| | |
|----------|--|
| 1 | Go to [9.1] Energy > Electricity price |
| 2 | Select the correct electricity price. |
| 3 | Confirm with the ✓ button. |

Note: When no schedule is set for the electricity price, this price will be taken into account.



INFORMATION

Price value ranging from 0.00~5000 valuta/kWh (with 2 significant values).

5.7.3 To set the scheduled electricity baseline price

Restriction: Only shown when bivalent or tank boiler is present.

When [9.4] **Electricity price schedule** is ON, the electric price follows a block based schedule. The **Electricity price baseline** will be used at times when no electricity price is scheduled (i.e. in between the schedule blocks).

| | |
|----------|---|
| 1 | Go to [9.2] Energy > Electricity price baseline |
| 2 | Select the correct electricity price baseline. |
| 3 | Confirm with the ✓ button. |

**INFORMATION**

Price value ranging from 0.00~5000 valuta/kWh (with 2 significant values).

5.7.4 To set the electricity price schedule

| | |
|----------|---|
| 1 | Go to [9.4] Energy > Electricity price schedule . |
| 2 | Program the selection using the scheduling screen. See " 5.5.2 Schedule screen: Example " [▶ 43]. |
| 3 | Confirm with the ✓ button. |

To enable the schedule:

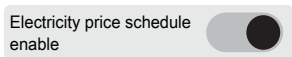
| | |
|----------|--|
| 1 | Go to [9.3] Energy > Electricity price schedule enable . |
| 2 | Switch Electricity price schedule enable ON:  |

5.7.5 To set the gas price

Restriction: Only when bivalent or tank boiler is present.

| | |
|----------|--|
| 1 | Go to [9.5] Energy > Gas price . |
| 2 | Select the correct gas price. |
| 3 | Confirm with the ✓ button. |

**INFORMATION**

Price value ranging from 0.00~5000 valuta/kWh (with 2 significant values).

5.7.6 About energy prices in case of an incentive per kWh renewable energy

An incentive can be taken into account when setting the energy prices. Although the running cost can increase, the total operation cost, taking into account the reimbursement will be optimized.

**NOTICE**

Make sure to modify the setting of the energy prices at the end of the incentive period.

To set the gas price in case of an incentive per kWh renewable energy

Calculate the value for the gas price with the following formula:

- Actual gas price+(Incentive/kWh×0.9)

For the procedure to set the gas price, see ["5.7.5 To set the gas price"](#) [▶ 51].

To set the electricity price in case of an incentive per kWh renewable energy

Calculate the value for the electricity price with following formula:

- Actual electricity price+Incentive/kWh

For the procedure to set the electricity price, see:

- ["5.7.2 To set the fixed electricity price \(no scheduling\)"](#) [▶ 50]
- ["5.7.3 To set the scheduled electricity baseline price"](#) [▶ 51]
- ["5.7.4 To set the electricity price schedule"](#) [▶ 51]

Example

This is an example and the prices and/or values used in this example are NOT accurate.

| Data | Price/kWh |
|----------------------------------|-----------|
| Gas price | 4.08 |
| Electricity price | 12.49 |
| Renewable heat incentive per kWh | 5 |

Calculation of the gas price

Gas price=Actual gas price+(Incentive/kWh×0.9)

Gas price=4.08+(5×0.9)

Gas price=8.58

Calculation of the electricity price

Electricity price=Actual electricity price+Incentive/kWh

Electricity price=12.49+5

Electricity price=17.49

| Price | Value in breadcrumb |
|-------------------------|---------------------|
| Gas: 4.08 /kWh | [9.5]=8.6 |
| Electricity: 12.49 /kWh | [9.1]=17 |

5.8 Other functionalities

5.8.1 To set Time/date

- 1 Go to [5.3] **Settings** > **Time/date**.

Note: If your region observes daylight saving time, you can switch [5.3] **Daylight savings time** ON.

5.8.2 To set the Location and language

You can change the location and language as follows:

- 1 Go to [5.9] **Settings** > **Location and language**.
- 2 Set the following:
 - **Country**
 - **Language**

| | |
|----------|----------------------------|
| 3 | Confirm with the ✓ button. |
|----------|----------------------------|

5.8.3 To change the **Display brightness**

You can change the display brightness as follows:

| | |
|----------|--|
| 1 | Go to [5.17] Settings > Display brightness . |
| 2 | Adjust the brightness. |
| 3 | Confirm with the ✓ button. |

5.8.4 To change the **Keyboard lay-out**

You can change the keyboard lay-out as follows:

| | |
|----------|--|
| 1 | Go to [5.12] Settings > Keyboard lay-out . |
| 2 | Choose: <ul style="list-style-type: none"> ▪ QWERTY ▪ AZERTY |
| 3 | Confirm with the ✓ button. |

5.8.5 Using quiet mode

About quiet mode

You can use quiet mode to decrease the sound of the outdoor unit. However, this also decreases the heating/cooling capacity of the system. There are multiple quiet mode levels.



INFORMATION

If the outdoor temperature is below zero, we recommend to NOT use the most quiet level.

To use quiet mode

| | |
|----------|--|
| 1 | Go to [5.2] Settings > Quiet operation . Note: Tap on the Outdoor bar from the home screen to quickly access [5.2]. |
| 2 | Do one of the following: |

| If you want to... | Then... | |
|----------------------------------|----------|--|
| Completely deactivate quiet mode | 1 | Tap Off . |
| | 2 | Confirm with the ✓ button. Result: The unit never runs in quiet mode. The user cannot change this. |

| If you want to... | Then... | |
|--------------------------------------|----------|--|
| Manually activate a quiet mode level | 1 | Tap Manual . |
| | 2 | Confirm with the ✓ button. |
| | 3 | In [5.2.1] Quiet mode - Manual , select the applicable quiet mode level. Possible values: <ul style="list-style-type: none">▪ Off▪ Quiet▪ More quiet▪ Most quiet |
| | 4 | Confirm with the ✓ button. Result: The unit always runs in the selected quiet mode level. The user cannot change this. |

| If you want to... | Then... | |
|---|----------|--|
| <ul style="list-style-type: none"> ▪ Enable the user to program a quiet mode schedule, AND/OR ▪ Configure restrictions based on local regulations | 1 | Tap Scheduled . |
| | 2 | If you want to program a quiet mode schedule: <ul style="list-style-type: none"> ▪ Tap Schedule. ▪ In [5.2.2] Quiet operation schedule, program when the unit has to use which quiet mode level. ▪ Confirm with the ✓ button. |
| | 3 | <p>Restriction: Restrictions are only available for the installer.</p> <p>If you want to configure restrictions based on local regulations:</p> <ul style="list-style-type: none"> ▪ Tap Restrictions. ▪ In [5.2.8] Restrictions, define the restrictions (when day/night starts, and which quiet mode level to use during day/night): <ul style="list-style-type: none"> - [5.2.9] AM Restricted time: Start of Day. Example: : At 6 a.m. - [5.2.10] AM Restricted level: Level used during the Day. Example: More quiet - [5.2.11] PM Restricted time: Start of Night. Example: : At 10 p.m. - [5.2.12] PM Restricted level: Level used during the Night. Example: Most quiet ▪ Tap the ↩ button. |
| | 4 | Confirm with the ✓ button. Result: <ul style="list-style-type: none"> ▪ The user can program the schedule in [5.2.2] Settings > Quiet operation > Schedule. ▪ The possible outcomes for the quiet mode differ depending on the schedule (if programmed) and the restrictions (if defined). See below. |



Possible outcomes when quiet mode is set to Scheduled

| If... | | Then quiet mode =... |
|--------------------------------------|----------------------|----------------------|
| Restrictions (time + level) defined? | Schedule programmed? | |
| No | No | OFF |
| | Yes | Follows schedule |

| If... | | Then quiet mode =... |
|--------------------------------------|----------------------|---|
| Restrictions (time + level) defined? | Schedule programmed? | |
| Yes | No | Follows restriction |
| | Yes | <ul style="list-style-type: none"> ▪ During restricted time: If restricted level is stricter than scheduled level, then follows restriction. Else, follows schedule. ▪ Outside restricted time: Follows schedule. |

To check if quiet mode is active

If one of the following icons is displayed on the home screen, quiet mode is active:

- : Quiet
- : More quiet
- : Most quiet

To program a quiet mode schedule

Restriction: Only possible if enabled by the installer.

| | |
|----------|---|
| 1 | <p>Go to [5.2.2] Settings > Quiet operation > Schedule.</p> <p>Note: Tap on the Outdoor bar from the home screen to quickly access [5.2].</p> |
| 2 | <p>Program the schedule.</p> <p>Possible actions: You can use the following system-defined preset values:</p> <ul style="list-style-type: none"> ▪ Off ▪ Quiet ▪ More quiet ▪ Most quiet <p>See "About quiet mode" [▶ 53].</p> <p>For more information about scheduling, see "5.5.1 Using and programming schedules" [▶ 39].</p> |

5.8.6 Using holiday mode

About holiday mode

During your holiday, you can use the holiday mode to deviate from your normal schedules without having to change them. While holiday mode is active, space heating/cooling operation and domestic hot water operation will be turned off. Room frost protection, water pipe freeze prevention and disinfection operation will remain active.

Typical workflow

Using holiday mode typically consists of the following stages:

- 1 Activating the holiday mode.
- 2 Setting the starting date and ending date of your holiday.

To check if holiday mode is activated and/or running

If  is displayed on the home screen, holiday mode is active.

To configure the holiday

Go to [5.27] **Settings** > **Holiday**, and do the following:

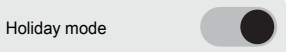
| | |
|----------|---|
| 1 | To activate the holiday mode, switch [5.27.1] Holiday mode ON:  |
| 2 | To define the holiday period: <ul style="list-style-type: none"> ▪ Go to [5.27.2] Holiday period. ▪ Under From, set the first day of your holiday. ▪ Under Till, set the last day of your holiday. ▪ Confirm with the ✓ button. <p>Note: The holiday period starts at noon (12h00) of the first day, and ends at noon (12h00) of the last day.</p> |

5.8.7 Using WLAN



INFORMATION



Restriction: WLAN settings are only visible when a WLAN cartridge is inserted in the user interface.

About the WLAN cartridge

The WLAN cartridge connects the system to the internet. As user you can then control the system via the ONECTA app.

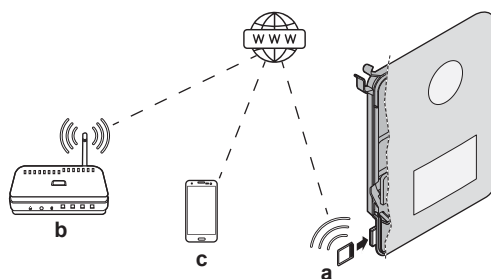
This needs the following components:



| | | |
|----------|---|---|
| a | WLAN cartridge | The WLAN cartridge needs to be inserted in the user interface. |
| b | Router | Field supply. |
| c | Smartphone + app  | The ONECTA app needs to be installed on the user's smartphone. See: http://www.onlinecontroller.daikineurope.com/  |

Configuration

To configure the ONECTA app, follow the in-app instructions. While doing this, the following actions and information are needed on the user interface:

- [8.3] Wireless gateway
 - [8.3.1] Wireless gateway (ON/OFF)
 - [8.3.2] Enable AP mode
 - [8.3.3] Reboot the gateway
 - [8.3.4] WPS
 - [8.3.5] Remove from cloud
 - [8.3.6] Home network connection
 - [8.3.7] Cloud connection

[8.3.1] Wireless gateway

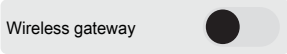
| | |
|----------|---|
| 1 | Go to [8.3.1]: Wireless gateway > Wireless gateway . |
| 2 | <p>Remark: Wireless gateway MUST stay in the OFF position, even when WLAN is installed:</p> <div style="border: 1px solid gray; padding: 5px; margin: 5px 0;">  </div> <p>Keeping the switch in OFF position will not impact WLAN functionality.</p> |

[8.3.2] Enable AP mode

Make the WLAN cartridge active as access point:

| | |
|----------|--|
| 1 | Go to [8.3.2]: Wireless gateway > Enable AP mode . |
| 2 | <p>This setting generates a random SSID and key (+ QR code) needed by the ONECTA app:</p> <div style="border: 1px solid gray; padding: 10px; margin: 10px 0;"> <p style="text-align: center; font-size: small;">AP mode enabled</p> <div style="display: flex; align-items: center; justify-content: center;">  <div style="font-size: x-small;"> <p>SSID DaikinAPXXXXX</p> <p>Key XYZ12345</p> </div> </div> <div style="display: flex; justify-content: space-between; margin-top: 10px;"> ⌂ ← </div> </div> <p>Press one of the buttons to exit the screen.</p> |

[8.3.3] Reboot

Reboot the WLAN cartridge:

| | |
|----------|---|
| 1 | Go to [8.3.3]: Wireless gateway > Reboot . |
| 2 | In the Reboot the gateway screen, choose Confirm to reboot. |

[8.3.4] WPS

Connect the WLAN cartridge to the router:

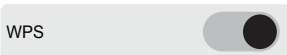
| | |
|---|--|
|  | <p>INFORMATION</p> <p>You can only use this function if it is supported by the software version of the WLAN, and the software version of the ONECTA app.</p> |
| 1 | Go to [8.3.4]: Wireless gateway > WPS . |
| 2 | <p>Switch WPS ON:</p> <div style="border: 1px solid gray; padding: 5px; margin: 5px 0;">  </div> |

[8.3.5] Remove from cloud

Remove the WLAN cartridge from the cloud:

| | |
|----------|--|
| 1 | Go to [8.3.5]: Wireless gateway > Remove from cloud . |
| 2 | In the Remove from cloud screen, choose Confirm to remove the WLAN from the cloud. |

[8.3.6] Home network connection

Read out the status of the connection to the home network:

| | |
|----------|---|
| 1 | Go to [8.3.6]: Wireless gateway > Home network connection . |
| 2 | Read out the connection status: <ul style="list-style-type: none"> ▪ Disconnected from [WLAN_SSID] ▪ Connected to [WLAN_SSID] |

[8.3.7] Cloud connection

Read out the status of the connection to the cloud:

| | |
|----------|--|
| 1 | Go to [8.3.7]: Wireless gateway > Cloud connection . |
| 2 | Read out the connection status: <ul style="list-style-type: none"> ▪ Not connected ▪ Connected |

5.9 Emergency operation

If the heat pump fails, the **Emergency selection** setting determines how the system will act.

| | |
|----------|---|
| 1 | Go to [5.23] Settings > Emergency selection . |
|----------|---|

Emergency selection

When a heat pump failure occurs, then this setting (same as setting [5.23]) defines whether the electrical heater (backup heater / booster heater / tank boiler if applicable) can take over the space heating and DHW operation.

When there is no automatic full take-over by the electrical heater, a pop-up (with the same content as setting [5.30]) appears where you can manually acknowledge that the electrical heater can fully take over (i.e. space heating to normal setpoint and DHW operation = ON).

When the house is unattended for longer periods, we recommend to use **auto SH reduced/DHW off** to keep energy consumption low.

| [5.23] | When heat pump failure occurs, then there is ... by the electrical heater | Full take-over |
|---------------|--|-----------------------------|
| Manual | No take-over: <ul style="list-style-type: none"> ▪ Space heating = OFF ▪ DHW operation = OFF | After manual acknowledgment |

| | | |
|-----------------------------|--|-----------------------------|
| Automatic | Full take-over: <ul style="list-style-type: none"> ▪ Space heating to normal setpoint ▪ DHW operation = ON | Automatic |
| auto SH reduced/ DHW on | Partial take-over: <ul style="list-style-type: none"> ▪ Space heating to reduced setpoint ▪ DHW operation = ON | After manual acknowledgment |
| auto SH reduced/ DHW off | Partial take-over: <ul style="list-style-type: none"> ▪ Space heating to reduced setpoint ▪ DHW operation = OFF | After manual acknowledgment |
| auto SH normal/ DHW off | Partial take-over: <ul style="list-style-type: none"> ▪ Space heating to normal setpoint ▪ DHW operation = OFF | After manual acknowledgment |



INFORMATION

If a heat pump failure occurs and **Emergency selection** is NOT set to **Automatic**, the following functions will remain active even if the user does NOT acknowledge emergency operation:

- Room frost protection
- Underfloor heating screed dryout
- Water pipe freeze prevention
- Disinfection

6 Energy saving tips

Tips about room temperature

- Make sure the desired room temperature is NEVER too high (in heating mode) or too low (in cooling mode), but ALWAYS according to your actual needs. Each saved degree can save up to 6% of heating/cooling costs.
- Do NOT increase/decrease the desired room temperature to speed up space heating/cooling. The space will NOT heat up/cool down faster.
- When your system layout contains slow heat emitters (example: underfloor heating), avoid large fluctuation of the desired room temperature and do NOT let the room temperature drop too low/rise too high. It will take more time and energy to heat up/cool down the room again.
- Use a weekly schedule for your normal space heating or cooling needs. If necessary, you can easily deviate from the schedule:
 - For shorter periods: You can overrule the scheduled room temperature until the next scheduled action. **Example:** When you have a party, or when you are leaving for a couple of hours.
 - For longer periods: You can use the holiday mode.

Tips about DHW tank temperature

- Make sure the desired DHW tank temperature is NOT too high. **Example:** After installation, lower the DHW tank temperature daily by 1°C and check if you still have enough hot water.
- Program to turn ON the domestic hot water pump ONLY during periods of the day when instant hot water is necessary. **Example:** In the morning and evening.

7 Maintenance and service

7.1 Overview: Maintenance and service

The installer has to perform a yearly maintenance. You can find the contact/helpdesk number via the user interface.

1 Go to [6.3]: **Information > Dealer information.**

As end user, you have to:

- Keep the area around the unit clean.
- Keep the user interface clean with a soft damp cloth. Do NOT use any detergents.
- Regularly check via [6.3] **Information > Sensors** that the water pressure is above 1 bar.

Refrigerant

Refrigerant type: R290

Global warming potential (GWP) value: 3

Periodical inspections for refrigerant leaks may be required depending on the applicable legislation. Contact your installer for more information.

Any repair and service work that would relate to refrigerant needs to be done by a Daikin certified technician.



WARNING

NEVER directly touch any accidental leaking refrigerant. This could result in severe wounds caused by frostbite.

8 Troubleshooting



Contact

For the symptoms listed below, you can try to solve the problem yourself. For any other problem, contact your installer. You can find the contact/helpdesk number via the user interface.







- | | |
|----------|--|
| 1 | Go to [6.3]: Information > Dealer information. |
|----------|--|

8.1 To display the help text in case of a malfunction

In case of a malfunction, the following icon will appear on the home screen depending on the severity:

- : Error
- : Warning
- : Information

You can get a short and a long description of the malfunction as follows:

- | | |
|----------|--|
| 1 | <p>Go to [11] Malfunctioning.</p> <p>Result: The ongoing malfunctions are shown with the following information:</p> <ul style="list-style-type: none"> ▪ The Level icon: <ul style="list-style-type: none"> - : Error - : Warning - : Information ▪ The error code ▪ The Type icon: <ul style="list-style-type: none"> - : Safety: these are critical errors that can result in an unsafe situation (e.g. refrigerant leak). - : Protection: these are errors related to the protection of the user or the system (eg overheating/disinfection/undercooling). - : Technical: these are all other errors indicating a technical problem of the unit or peripherals (e.g. sensor abnormality). |
| 2 | <p>Tap on the error message in the error screen.</p> <p>Result: A long description of the error is displayed on the screen.</p> |

8.2 To check the malfunction history

Always check the malfunction history while troubleshooting.

Conditions: The user permission level is set to advanced end user.

- | | |
|----------|---|
| 1 | Go to [11]: Malfunction history. |
|----------|---|

You see a list of the most recent malfunctions.

8.3 Symptom: You are feeling too cold (hot) in your living room

| Possible cause | Corrective action |
|---|--|
| The desired room temperature is too low (high). | <p>Increase (decrease) the desired room temperature. See "5.3.10 To change the desired room temperature" [▶ 30].</p> <p>If the problem recurs daily, do one of the following:</p> <ul style="list-style-type: none"> ▪ Increase (decrease) the room temperature preset value. See the user reference guide. ▪ Adjust the room temperature schedule. See "5.5.2 Schedule screen: Example" [▶ 43]. |
| The desired room temperature cannot be reached. | <p>Increase the desired leaving water temperature in accordance with the heat emitter type. See "5.3.12 To change the desired leaving water temperature" [▶ 31].</p> |
| The weather-dependent curve is set incorrectly. | <p>Adjust the weather-dependent curve. See "5.6 Weather-dependent curve" [▶ 47].</p> |

8.4 Symptom: The water at the tap is too cold

| Possible cause | Corrective action |
|---|---|
| <p>You ran out of domestic hot water because of unusually high consumption.</p> <p>The desired DHW tank temperature is too low.</p> | <p>If you immediately need domestic hot water, activate:</p> <ul style="list-style-type: none"> ▪ [4.1] Powerful heating. This is the quickest heat-up, but consumes extra energy. See "Powerful heating mode" [▶ 37]. ▪ [4.3] Manual. This is an efficient heat-up, but can take longer than powerful operation. <p>If the problems recur daily, do one of the following:</p> <ul style="list-style-type: none"> ▪ Increase the DHW tank temperature preset value. See the user reference guide. ▪ Adjust the DHW tank temperature schedule. Example: Program to additionally heat up the DHW tank to a somewhat lower value during the day. See "5.5.2 Schedule screen: Example" [▶ 43]. |

8.5 Symptom: Heat pump failure

When the heat pump fails to operate, the backup heater and/or booster heater can serve as an emergency heater. It then takes over the heat load either automatically or by manual interaction.

- When **Emergency** is set to **Automatic** and a heat pump failure occurs, the backup heater automatically takes over the heat load, and the booster heater in the optional tank takes over the domestic hot water production.
- When **Emergency** is set to **Manual** and a heat pump failure occurs, the domestic hot water heating and space heating stops.

To manually recover it via the user interface, go to the **Malfunctioning** main menu screen and confirm whether the backup heater and/or booster heater can take over the heat load or not.

- Alternatively, when **Emergency** is set to:
 - **auto SH reduced/DHW on**, space heating is reduced but domestic hot water is still available.
 - **auto SH reduced/DHW off**, space heating is reduced and domestic hot water is NOT available.
 - **auto SH normal/DHW off**, space heating operates as normally but domestic hot water is NOT available.

Similarly as in **Manual** mode, the unit can take the full load with the backup heater and/or booster heater if the user activates this via the **Malfunctioning** main menu screen.



To keep energy consumption low, we recommend to set **Emergency** to **auto SH reduced/DHW off** if the house is unattended for longer periods.

When the heat pump fails,  or  will appear on the user interface.

| Possible cause | Corrective action |
|-----------------------|---|
| Heat pump is damaged. | See "8.1 To display the help text in case of a malfunction" [▶ 63]. |

8.6 Symptom: The system is making gurgling noises after commissioning



| Possible cause | Corrective action |
|------------------------------|--|
| There is air in the system. | Purge air from the system. ^(a) |
| Incorrect hydraulic balance. | To be performed by the installer: <ol style="list-style-type: none"> 1 Perform hydraulic balancing to assure that the flow is correctly distributed between the emitters. 2 If hydraulic balancing is not sufficient, it is recommended to increase the Delta T heating ([1.14] / [2.14]) value. 3 If hydraulic balancing is not sufficient, it is recommended to increase the Delta T cooling ([1.18] / [2.17]) value. |

| Possible cause | Corrective action |
|-----------------------|---|
| Various malfunctions. | Check if  or  is displayed on the home screen of the user interface. See "8.1 To display the help text in case of a malfunction" [▶ 63] for more information about the malfunction. |

^(a) We recommend to purge air with the air purge function of the unit (to be performed by the installer). If you purge air from the heat emitters or collectors, mind the following:



WARNING

Air purging heat emitters or collectors. Before you purge air from heat emitters or collectors, check if  or  is displayed on the home screen of the user interface.

- If not, you can purge air immediately.
- If yes, make sure that the room where you want to purge air is sufficiently ventilated. **Reason:** In case of a breakdown, refrigerant might leak into the water circuit, and subsequently into the room when you purge air from the heat emitters or collectors.

9 Relocation

9.1 Overview: Relocation

If you want to relocate parts of your system, contact your installer. You can find the contact/helpdesk number via the user interface.

10 Disposal

When you want to dispose of the unit, do NOT do it yourself but contact a Daikin certified technician.



NOTICE

Do NOT try to dismantle the system yourself: dismantling of the system, treatment of the refrigerant, oil and other parts MUST comply with applicable legislation. Units MUST be treated at a specialised treatment facility for reuse, recycling and recovery.

11 Glossary

DHW = Domestic hot water

Hot water used, in any type of building, for domestic purposes.

LWT = Leaving water temperature

Water temperature at the water outlet of the unit.

Dealer

Sales distributor for the product.

Authorised installer

Technical skilled person who is qualified to install the product.

User

Person who is owner of the product and/or operates the product.

Applicable legislation

All international, European, national and local directives, laws, regulations and/or codes that are relevant and applicable for a certain product or domain.

Service company

Qualified company which can perform or coordinate the required service to the product.

Installation manual

Instruction manual specified for a certain product or application, explaining how to install, configure and maintain it.

Operation manual

Instruction manual specified for a certain product or application, explaining how to operate it.

Accessories

Labels, manuals, information sheets and equipment that are delivered with the product and that need to be installed according to the instructions in the accompanying documentation.

Optional equipment

Equipment made or approved by Daikin that can be combined with the product according to the instructions in the accompanying documentation.

Field supply

Equipment NOT made by Daikin that can be combined with the product according to the instructions in the accompanying documentation.

12 Installer settings: Tables to be filled in by installer

12.1 Configuration wizard

| | Setting | Fill in... |
|---------|---|------------|
| [10.1] | Location and language [5.9] | |
| | Country | |
| | Language | |
| [10.2] | Timezone [5.10] (only for Russia) | |
| | Timezone | |
| [10.3] | Time/date [5.3] | |
| | Daylight savings time (ON/OFF) | |
| [10.4] | System 1/4 | |
| | Number of zones | |
| | Bivalent [5.37] | |
| | DHW Tank | |
| | DHW Tank type | |
| [10.5] | System 2/4 | |
| | — | |
| [10.6] | System 3/4 | |
| | — | |
| [10.7] | System 4/4 | |
| | Emergency selection [5.23] | |
| [10.8] | Backup heater | |
| | Grid configuration | |
| | Maximum capacity [5.34] | |
| | Fuse >10A (ON/OFF) | |
| [10.9] | Main zone 1/4 | |
| | Emitter type [1.11] | |
| | Control [1.12] | |
| [10.10] | Main zone 2/4 | |
| | Heating setpoint mode [1.5] | |
| | Cooling setpoint mode [1.7] | |
| [10.11] | Main zone 3/4 (Heating WD curve) [1.8] | |
| | LWT | |
| | Outside temperature | |

| | Setting | Fill in... |
|---------|---|------------|
| [10.12] | Main zone 4/4 (Cooling WD curve) [1.9] | |
| | LWT | |
| | Outside temperature | |
| [10.13] | Additional zone 1/4 | |
| | Emitter type [2.11] | |
| | Control [2.12] | |
| [10.14] | Additional zone 2/4 | |
| | Heating setpoint mode [2.5] | |
| | Cooling setpoint mode [2.7] | |
| [10.15] | Additional zone 3/4 (Heating WD curve) [2.8] | |
| | LWT | |
| | Outside temperature | |
| [10.16] | Additional zone 4/4 (Cooling WD curve) [2.9] | |
| | LWT | |
| | Outside temperature | |
| [10.17] | DHW 1/2 | |
| | Operation mode [4.7] | |
| [10.18] | DHW 2/2 | |
| | Tank setpoint [4.5] | |
| | Hysteresis [4.12] | |

12.2 Settings menu

| | Setting | Fill in... |
|--|----------------------------|------------|
| Main zone | | |
| | Ext thermostat type [1.13] | |
| Additional zone (if applicable) | | |
| | Ext thermostat type [2.13] | |
| Information | | |
| | Dealer information [6.2] | |

